

Network Video Recorder (NVR) User Manual

Issue

V4.6.5

Date

2022-11-11

Legal Notice

Trademark Statement:

VGA is trademark of IBM Corporation.

The Windows logo and Windows are trademarks or registered trademarks of Microsoft Corporation.

Other trademarks or company names that may be mentioned in this document are the property of their respective owners.

Responsibility statement:

To the extent permitted by applicable law, in no event shall the Company compensate for any special, incidental, consequential, or consequential damages resulting from the contents of the documentation and the products described, nor any Compensation for loss of profits, data, goodwill, loss of documentation or expected savings.

The products described in this document are provided "as it is at present", except as required by applicable law, the company does not provide any warranty or implied warranties, including but not limited to, merchantability, quality satisfaction, and fitness for a particular purpose, does not infringe the rights of third parties and other guarantees.

Privacy Protection Reminder:

If you have installed our products, and you may be collected personal information such as faces, fingerprints, license plates, emails, telephones, and GPS. In the process of using the product, you need to comply with the privacy protection laws and regulations of your region or country to protect the legitimate rights and interests of others. For example, provide clear and visible signs, inform the relevant rights holders of the existence of video surveillance areas, and provide corresponding contact information.

About This Document:

This document is for several models. The appearance and function of the products are subject to the actual products.

Any loss caused by failure to follow the instructions in this document is the responsibility of the user.

This document will be updated in real time according to the laws and regulations of the relevant region. For details, please refer to the product's paper, electronic CD, QR code or official website. If the paper and electronic files are inconsistent, please refer to the electronic file as.

The company reserves the right to modify any information in this document at any time. The revised content will be added to the new version of this document without prior notice. This document may contain technical inaccuracies, or inconsistencies with product features and operations, or typographical errors, which are subject to the company's final interpretation.

If the obtained PDF document cannot be opened, please use the latest version or the most mainstream reading tool.

Network Security Advice

Required measures to ensure basic network security of equipment:

Modify the password regularly and set a strong password.

Devices that do not change the password regularly or use a weak password are the easiest to be hacked. Users are advised to modify the default password and use strong passwords whenever possible (minimum of 6 characters, including uppercase, lowercase, number, and symbol).

Update firmware

According to the standard operating specifications of the technology industry, the firmware of NVR, DVR and IP cameras should be updated to the latest version to ensure the latest features and security of the device.

The following recommendations can enhance your device's network security:

1. Change your password regularly

Regularly modifying the login credentials ensures that authorized users can log in to the device.

2. Modify the default HTTP and data ports

Modify the device's default HTTP and data ports, which are used for remote communication and video browsing.

These two ports can be set to any number between 1025 and 65535. Changing the default port reduces the risk of the intruder guessing which port you are using.

3. Use HTTPS/SSL encryption

Set up an SSL certificate to enable HTTPS encrypted transmission. The information transmission between the front-end device and the recording device is fully encrypted.

4. Enable IP filtering

After IP filtering is enabled, only devices with the specified IP address can access the system.

5. Change the ONVIF password

For some old versions of the IP camera firmware, after the system's master password is changed, the ONVIF password will not be automatically changed. You must update the camera's firmware or manually update the ONIVF password.

6. Only forward the ports that must be used

Only forward the network ports that must be used. Avoid forwarding a long port area. Do not set the device's IP to DMZ.

If the camera is connected locally to the NVR, you do not need to forward the port for each camera. Only the ports of the NVR need to be forwarded.

7. Use a different username and password on the video surveillance system.

In the unlikely event that your social media account, bank, email, etc. account information is leaked, the person who obtained the account information will not be able to invade your video surveillance system.

8. Restrict the permissions of the ordinary account

If your system is serving multiple users, make sure that each user has permission to access only its permissions.

UPnP

When the UPnP protocol is enabled, the router will automatically map the intranet ports.

Functionally, this is user-friendly, but it causes the system to automatically forward the data of the corresponding port, causing the data that should be restricted to be stolen by others.

If you have manually opened HTTP and TCP port mappings on your router, we strongly recommend that you turn this feature off. In actual usage scenarios, we strongly recommend that you do not turn this feature on.

SNMP

If you do not use the SNMP, we strongly recommend that you turn it off. The SNMP function is limited to temporary use for testing purposes.

Multicast

Multicast technology is suitable for the technical means of transmitting video data in multiple video storage devices. There have been no known vulnerabilities involving multicast technology so far, but if you are not using this feature, we recommend that you turn off multicast playback on your network.

12. Check logs

If you want to know if your device is secure, you can check the logs to find some unusual access operations. The device log will tell you which IP address you have tried to log in or what the user has done.

Physically protect your device

For the safety of your device, we strongly recommend that you physically protect your device from unauthorized boring operations. We recommend that you place the device in a locked room and place it in a locked cabinet with a locked box.

It is highly recommended that you use PoE to connect IP cameras to NVR.

IP cameras connected to the NVR using PoE will be isolated from other networks so that they cannot be accessed directly.

Network isolation between NVR and IP cameras

We recommend isolating your NVR and IP cameras from your computer network. This will protect unauthorized users on your computer network from having access to these devices.

About This Document

Purpose

This document describes in detail the installation, use, and interface operation of the NVR (Network Video Recorder) device.

Modify Log

ID	Version	Log	Release Time
1	V 4.0	Initial Release	2017/10
2	V 4.1	Add new function	
3	V 4.1.3	Perfect interface, add new models	
4	V 4.1.5	Add reverse playback Open data port 2	20180106
5	V 4.1.6	Add 4 split screens of automatic adjusting main stream or sub stream. Add private protocol access. Support multi-screen playback. Add the schedule recording function by channel setting Increase the allocation of permissions by channel	
	V 4.2	Add boot wizard Add toolbar Add manual recording and instant playback Add multiple clicks to enlarge Add user lockout Remove the upper right corner to display the alarm warning Add the view of the latest alarm information, modify the manual alarm	

		<p>Modify quick navigation content</p> <p>Preview channel and modify network parameter function on IPC side</p> <p>Support for copying to some or all channels</p> <p>Remove the full screen function</p> <p>Add backend backup</p> <p>Add video dual authentication</p> <p>Intelligent motion detection</p> <p>Add the color to distinguish the video type, add the video type search</p> <p>Add sound switch</p> <p>Add instant playback</p> <p>Remove the timeline function</p> <p>Increase intelligence analysis</p> <p>Increase test DDNS function</p> <p>Increase test mail function</p> <p>Modify the time precision to half an hour, remove the recording plan master switch</p> <p>Add hardware information</p> <p>Added video dual authentication and boot wizard configuration function</p> <p>Add alarm log</p> <p>Add interval update profile</p>	
6	V 4.2.1	<p>Add the NTP synchronization interval and add the manual NTP synchronization interval.</p> <p>Add access to thermal imaging cameras and display IPC product models</p> <p>Remove auto hide</p> <p>Add the patrol route and line-scan function</p> <p>Add upgrade IPC, restart IPC, restore factory IPC</p> <p>Increase the selection of main and sub stream backups</p> <p>Add playback button to play video</p> <p>Add UI to display detailed intelligent analysis of IPC</p> <p>Add 802.1x functionality</p>	





		<ul style="list-style-type: none">Add SNMP functionAdd upgrade device featuresAdd the timing restart functionAdd U disk upgrade display progress bar	
7	V 4.2.4	<ul style="list-style-type: none">Increase U-boot and kernel version displayIncrease P2P status displayIncrease signal type displayIncrease POE icon displayIncrease SSL access IPC, special models supportOptimize username and password saving methodsIncrease batch backupIncrease fixed point playbackIncrease hard disk alarmOptimize the recording expiration time input mode to be editableAdd city information for each time zoneAdd face recognitionAdd P2P server	
8	V 4.3	<ul style="list-style-type: none">Add pattern unlockAdd mailbox reset passwordIncrease the secure question reset passwordAdd 1+7 split screenAdd channel information displayAdd 3D dome cameraRemove live video type switchAdd RAIDAdd S.M.A.R.TAdd formatting (fat32 and NTFS)Support quick download event video backupAdd event video backupAdd pop-up full screen and sending screenshot by emailAdd IPC intelligent analysis configuration	

		<p>Add manual input automatic logout time</p> <p>Restore factory refinement</p>	
9	V4.4	<p>Support adding POE cameras automatically or manually.</p> <p>Support NVR network provided by 3G/4G modem.</p> <p>Support cloud storage.</p> <p>Add disk detection, disk group and multi channels recording.</p> <p>Support license plate recognition management.</p> <p>Support through RTSP to add cameras.</p> <p>Add thermal imaging and face detection functions.</p> <p>Add alarm of IP address conflict and abnormal internet connection.</p>	
10	V4.5	<p>Add disk capacity calculation</p> <p>Add viewing network traffic</p> <p>Add alarm output function</p> <p>Add ROI</p> <p>Add the function of human body thermometer</p> <p>Add temperature schedule linkage</p> <p>Add smart functions</p> <p>Add smart tracking</p> <p>Add microphone</p> <p>Add the synchronization camera time</p> <p>Add personnel counting</p> <p>Add IO control push message alarm</p> <p>Add the log of alarm events send by Email</p>	202005
11	V4.5.1	<p>Add mask detection configuration</p> <p>Increase personnel counting configuration</p> <p>Optimize the function of adding camera channels manually</p> <p>Optimize record schedule</p> <p>Optimized auto sequence</p> <p>Increase NAT port settings</p> <p>Increase network packet capture</p>	

		<p>Add advance settings to monitor channel when logout</p> <p>Add license plate data import and export</p> <p>Detailed alarm events and logs</p> <p>Add snapshot of real-time video and playback video</p>	
12	V4.6.5	<p>Add HTTPS port configuration</p> <p>Optimize the logic of IPC WEB jump from external network</p> <p>Add multiple layouts</p> <p>Support selection of preview strategy</p> <p>Add audio playback function at WEB</p> <p>Add event retrieval recording and backing up data through events at WEB</p> <p>Add modification of the IP address and subnet mask of the IPC</p> <p>Support ANR/auto network replenishment</p> <p>Add WDDA function of disk</p> <p>Support HTTPS port, used for https access to WEB pages</p> <p>Add electronic fence feature of active deterrent camera</p> <p>Add the allowable phone number and refine the backup authority</p> <p>Add multiple layouts to auto sequence</p> <p>System log is saved to flash and hard disk</p>	
13	V4.6.5	<p>Add local intelligent analysis</p> <p>Add remarks about special functions</p> <p>Modify the pictures</p> <p>Add advanced intelligent analysis</p> <p>Add ADAM</p>	

Symbol Conventions

The symbols may be found in this document, which are defined as follows:

Symbol	Description
 DANGER	It's for warning when a hazard or a hazardous condition is likely to be life-threatening.
 WARNING	Alerts you to a medium or low risk hazard that, if not avoided, could result in moderate or minor injury.
 CAUTION	Alerts you to a potentially hazardous situation that, if not avoided, could result in equipment damage, data loss, performance deterioration, or unanticipated results.
 TIP	Provides a tip that may help you solve a problem or save time.
 NOTE	Provides additional information to emphasize or supplement important points in the main text.

Safety instructions

The following are the correct use of the product. In order to prevent danger and prevent property damage, please read this manual carefully before using the device and strictly comply that when using it. Please save the manual after reading.

Requirements

The front-end devices of POE are required to be installed indoors.

The NVR device does not support wall mounting.

Do not place and install the device in direct sunlight or near heat-generating equipment.

Do not install the device in a place subject to high humidity, dust or soot.

Please keep the equipment installed horizontally or install the equipment in a stable place, taking care to prevent the product from falling.

Do not drop or spill liquid into the device and ensure that no liquid-filled items are placed on the device to prevent liquid from flowing into the device.

Install the device in a well-ventilated area, and do not block the ventilation openings of the device.

Use the device only within the rated input and output range.

Do not disassemble the device at will.

Please transport, use and store the device within the permissible humidity and temperature range.

Power Requirement

Be sure to use the specified manufacturer's model battery, otherwise there is a danger of explosion!

Be sure to use the battery as required, otherwise there is a danger of the battery catching fire, exploding or burning!

Only use the same model of battery when replacing the battery!

Be sure to dispose of the used battery as the instruction of battery!

Be sure to use the power adapter that meets standard with the device, otherwise the personal injury or equipment damage caused by the user will be borne by the user.

Use a power supply that meets the SELV (Safety Extra Low Voltage) requirements and supply power according to the rated voltage of IEC60950-1 in accordance with the Limited Power Source. The specific power supply requirements are based on the equipment label. Connect the Class I product to the power outlet with a protective ground connection. The appliance is coupled to the port unit. Keep it at a proper angle for normal use.

Important Statement

Users are required to enable and maintain the lawful interception (LI) interfaces of video surveillance products in strict compliance with relevant laws and regulations. Installation of surveillance devices in an office area by an enterprise or individual to monitor employee behavior and working efficiency outside the permitted scope of the local law and use of video surveillance devices for eavesdropping of illegal purposes constitute behaviors of unlawful interception.

This manual is only for reference and does not ensure that the information is totally consistent with the actual products. For consistency, see the actual products.

Contents

Legal Notice	ii
Network Security Advice	iv
About This Document	vii
Purpose.....	vii
Modify Log	vii
Symbol Conventions	xi
Safety instructions	xiii
Requirements	xiii
Power Requirement	xiii
Important Statement	xiv
Contents	xv
1 Preface.....	1
1.1 Product Description.....	1
1.2 Product Features.....	1
1.2.1 Cloud Upgrade	1
1.2.2 Real-time Monitoring.....	2
1.2.3 Playback.....	2
1.2.4 User Management	2
1.2.5 Storage Funtion	2
1.2.6 Alarm Function	3
1.2.7 Network Monitoring.....	3
1.2.8 Split Screen	3
1.2.9 Recording Function.....	3
1.2.10 Backup Function	4
1.2.11 External Device Control.....	4
1.2.12 Accessibility.....	4

- 2 Product Structure 5**
 - 2.1 Front Panel 5
 - 2.2 Back Panel..... 7
 - 2.3 Important Notes..... 15
 - 2.4 About This User Manual 16
 - 2.5 Installation Environment and Precautions 16
- 3 Install device..... 18**
 - 3.1 Process 18
 - 3.2 Unpacking Inspection..... 19
 - 3.3 Install Hard Disk 19
 - 3.3.1 Install One or Two Hard disks 20
 - 3.3.2 Install Four Hard disks 21
 - 3.3.3 Install Eight Hard disks 22
- 4 Basic Operations 23**
 - 4.1 Power on the Device..... 23
 - 4.2 Activation..... 24
 - 4.3 Power off the Device 27
 - 4.4 Login to the System..... 28
- 5 Wizard..... 31**
- 6 Quick Navigation..... 40**
 - 6.1 Quick Bar 40
 - 6.2 Real Time Video Bar..... 45
 - 6.3 Playback 47
 - 6.3.1 Time Search 50
 - 6.3.2 Picture Grid 51
 - 6.3.3 Event Recording..... 53
 - 6.3.4 Backup List 55
 - 6.4 AI Recognition (Only for Some Models) 56
 - 6.4.1 Real Time Comparison..... 56
 - 6.4.1.1 Human Face 56
 - 6.4.1.2 Vehicle License Plate 57
 - 6.4.1.3 Vehicle and Full Body..... 58

6.4.1.4 Real-time Body Temperature Filter.....	59
6.4.2 Smart Search	61
6.4.2.1 Human Face Search	61
6.4.2.2 Vehicle License Plate Search	63
6.4.2.3 Full Body Search	64
6.4.2.4 Vehicle Search.....	65
6.4.2.5 Body Temperature Search	66
6.4.2.6 Personnel Count.....	67
6.4.3 Archives Library	67
6.4.3.1 Face Library	68
6.4.3.2 License Plate Library	69
6.4.4 Comparison Configuration	71
6.4.4.1 Face Comparison	71
6.4.4.2 License Comparison.....	73
6.4.4.3 Temperature Comparison	74
6.4.4.4 Mask Detection Configuration.....	77
6.4.4.5 Personnel Count Configuration.....	79
6.5 Attendance (Only for Some Models).....	81
6.5.1 Attendance Data	81
6.5.2 Attendance Management	82
6.6 Thermal Temperature (Only for Some Models)	85
6.6.1 Temperature Parameters	86
6.6.2 Temperature Area	90
6.6.3 Schedule Linkage	93
6.6.4 Advanced.....	94
6.6.5 Inquire.....	95
6.7 Channel Information.....	96
6.8 Main Menu.....	97
7 UI System Setting	98
7.1 Channel Management.....	98
7.1.1 Camera	98
7.1.1.1 Add Camera Automatically	100

7.1.1.2 Add Camera Manually	101
7.1.1.3 Add Camera by RSTP	102
7.1.1.4 Delete Camera.....	103
7.1.1.5 Operate Camera	103
7.1.2 Encode Parameter.....	105
7.1.3 Sensor Setting	106
7.1.4 OSD Settings.....	107
7.1.5 Privacy Zone	108
7.1.6 ROI.....	109
7.1.7 Microphone (Only for Some Models).....	110
7.1.8 Human Thermometer (Only for Some Models)	112
7.1.8.1 Parameter Configuration	112
7.1.8.2 Thermal Mapping.....	118
7.1.8.3 Thermal Calibration	119
7.1.9 Smart (Only for Some Models).....	120
7.1.9.1 AI Multiobject.....	121
7.1.9.2 License Plate Recognition.....	123
7.1.10 Intelligent Tracking (Only for Some Models)	124
7.2 Record Setting.....	127
7.2.1 Record Schedule	127
7.2.2 Disk.....	128
7.2.3 RAID (Only for Some Models).....	130
7.2.4 Storage Mode	131
7.2.5 S.M.A.R.T.....	132
7.2.5.1 S.M.A.R.T.....	132
7.2.5.2 WDDA.....	132
7.2.6 Disk Detection.....	133
7.2.7 Cloud Storage (Only for Some Models).....	135
7.2.8 Disk Calculation.....	136
7.2.9 FTP.....	138
7.3 Alarm Management.....	139
7.3.1 General.....	139

7.3.1.1 General.....	139
7.3.1.2 IO control push	140
7.3.2 Motion Detection	140
7.3.3 Video Loss.....	143
7.3.4 Advanced Intelligent Analysis (Only for Some Models)	144
7.3.4.1 Smoker Detection	145
7.3.4.2 Smoke and Flame Detection	148
7.3.4.3 Fire Spot Detection	152
7.3.5 Intelligent Analysis (Only for Some Models).....	155
7.3.6 Alarm In	159
7.3.7 Abnormal Alarm.....	161
7.3.8 Alarm Out.....	162
7.3.8.1 Alarm Out	162
7.3.8.2 Camera Alarm out	163
7.3.9 ADAM (Only for Some Models).....	165
7.3.10 Local Intelligent Analysis (Only for Some Models).....	166
7.3.10.1 General.....	166
7.3.10.2 Intrusion	167
7.4 Network Management	170
7.4.1 Network.....	171
7.4.1.1 IP.....	171
7.4.1.2 Port.....	171
7.4.1.3 IPv4CCTV (Only for Some Models)	172
7.4.1.4 POE (Only for Some Models).....	173
7.4.1.5 WiFi Parameter (Only for Some Models)	174
7.4.1.6 WiFi Network (Only for Some Models).....	175
7.4.2 802.1 X.....	176
7.4.3 DDNS.....	177
7.4.4 Port Mapping.....	178
7.4.4.1 Port Mapping	178
7.4.4.2 NAT Port	179
7.4.5 Email.....	180

7.4.6 P2P	182
7.4.7 IP Filter	183
7.4.8 SNMP.....	184
7.4.9 3G/4G.....	185
7.4.10 PPPOE.....	187
7.4.11 POE Status (Only for Some Models)	188
7.4.12 Network Traffic	189
7.4.13 Platform Access.....	190
7.5 System Management	193
7.5.1 Information	193
7.5.2 General.....	196
7.5.2.1 System	196
7.5.2.2 Date and Time.....	197
7.5.2.3 Time Zone.....	198
7.5.2.4 DST.....	199
7.5.2.5 Sync Camera Time	200
7.5.3 User Account.....	201
7.5.3.1 User.....	201
7.5.3.2 Advance Setting	203
7.5.3.3 App Verification	204
7.5.4 Security Center	205
7.5.4.1 Password.....	205
7.5.4.2 Pattern Unlock	206
7.5.4.3 Secure Email	207
7.5.4.4 Secure Question	208
7.5.5 Layout	209
7.5.6 Auxliary Screen (Only for Some Models).....	212
7.5.7 Logs	213
7.5.7.1 System Log	213
7.5.7.2 Event Log.....	214
7.5.8 Maintenance.....	215
7.5.9 Auto Reboot	217

8 WEB Quick Start	219
8.1 Activation.....	219
8.2 Login and Logout	221
8.3 Browsing Videos	225
8.3.1 Browsing Real-Time Videos	225
8.3.2 Live Video.....	227
8.3.3 Channel Operation	228
8.3.4 PTZ Control and Setting	229
8.3.5 Sensor Setting	231
8.3.6 Layout	233
8.4 Playback	234
8.4.1 Video Playback.....	234
8.5 Alarm Search.....	236
8.5.1 Channel Alarm	236
8.6 Attendance (Only for Some Models).....	237
8.6.1 Attendance Data	237
8.6.2 Attendance Management	238
8.7 AI Recognition (Only for Some Models)	242
8.7.1 Real Time Comparison.....	243
8.7.1.1 Human Face	243
8.7.1.2 Vehicle License Plate	243
8.7.1.3 Vehicle and Full Body.....	244
8.7.1.4 Real Time Body Temperature Filter.....	245
8.7.2 Smart Search	246
8.7.2.1 Human Face Search	246
8.7.2.2 Vehicle License Plate Search	247
8.7.2.3 Full Body Search	248
8.7.2.4 Vehicle Search.....	249
8.7.2.5 Body Temperature Search	250
8.7.2.6 Personnel Count	250
8.7.3 Archives Library	251
8.7.3.1 Face Library.....	252

8.7.3.2 License Plate Library	253
8.7.4 Comparison Configuration	253
9 System Setting.....	258
9.1 Channel	258
9.1.1 Camera	258
9.1.1.1 Protocol Management	261
9.1.2 Encode	262
9.1.3 Sensor Setting	263
9.1.4 OSD	264
9.1.5 Privacy Zone	265
9.1.6 ROI.....	266
9.1.7 Microphone (Only for Some Models).....	266
9.1.8 Human Thermometer (Only for Some Models)	267
9.1.9 Smart (Only for Some Models).....	268
9.1.10 Intelligent Tracking (Only for Some Models)	269
9.2 Record	270
9.2.1 Record Schedule	270
9.2.2 Disk.....	271
9.2.3 Storage Mode	272
9.2.4 RAID (Only for Some Models).....	273
9.2.5 S.M.A.R.T.....	275
9.2.6 Disk Calculation.....	276
9.2.7 Cloud Storage (Only for Some Models).....	277
9.2.8 FTP.....	278
9.3 Alarm	278
9.3.1 General.....	278
9.3.1.1 General.....	278
9.3.1.2 IO Control Push	279
9.3.2 Motion Detection	280
9.3.3 Video Loss.....	281
9.3.4 Advanced intelligent Analysis (Only for Some Models)	282
9.3.5 Intelligent Analysis (Only for Some Models).....	287

9.3.6 Alarm In	288
9.3.7 Abnormal Alarm	289
9.3.8 Alarm out	289
9.3.9 ADAM	290
9.4 Network.....	291
9.4.1 Network.....	291
9.4.2 DDNS.....	293
9.4.3 Email.....	294
9.4.4 Port Mapping.....	295
9.4.4.1 Port Mapping	295
9.4.4.2 NAT port	296
9.4.5 P2P	296
9.4.6 IP Filter	297
9.4.7 802.1X.....	299
9.4.8 SNMP.....	300
9.4.9 Web Mode	302
9.4.10 3G/4G.....	303
9.4.11 PPPOE.....	303
9.4.12 POE Status (Only for Some Models)	304
9.4.13 Platform Access.....	305
9.5 System.....	305
9.5.1 Device Information	306
9.5.2 General.....	308
9.5.3 User Account.....	311
9.5.3.1 Add User	311
9.5.3.2 Adv.Setting.....	313
9.5.3.3 App Verification	314
9.5.4 Security Center.....	314
9.5.4.1 Password.....	314
9.5.4.2 Secure Email	315
9.5.4.3 Secure Question	315
9.5.5 Logs	316

9.5.5.1 System Logs.....	316
9.5.5.2 Event.....	316
9.5.6 Maintenance.....	317
9.5.7 Auto Reboot.....	318
9.6 Local (Supplied for IE Browser).....	319
10 Disk Compatibility.....	321

1 Preface

1.1 Product Description

This product is a high-performance NVR device. The product has local preview, video multi-screen split display, local real-time storage function of video files, add support for mouse shortcut operation, remote management and control.

This product supports three storage methods: central storage, front-end storage, and client storage. The front-end monitoring point can be located anywhere in the network without geographical restrictions. It is combined with other front-end devices such as network cameras, network construction of network video server, and professional video surveillance systems to form a powerful security monitoring network. In the networked deployment system of this product, the central point and the monitoring point need only one network cable to connect. There is no need to connect video and audio cables. The operation is simple, and the cost of wiring and maintenance cost is low.

This product is widely used in public security, transportation, electric power, education and other industries.

1.2 Product Features

1.2.1 Cloud Upgrade

For devices that have access to the public network, you can update the software of the devices online.

1.2.2 Real-time Monitoring

It has a VGA (Video Graphics Array) port and an HDMI (High Definition Media Interface) port. It can realize monitoring function through monitor and display, and support VGA and HDMI output at the same time.

1.2.3 Playback

Each channel has independent real-time recordings and multi functions, such as retrieval, playback, network monitoring, video query, and download. Please refer to chapter Playback

Multiple playback modes: slow release, fast release, reverse playback, and frame-by-frame playback.

The exact time when the event occurred can be displayed during playback of the recording. You can select any area of the screen for partial magnification.

1.2.4 User Management

Each user group has a rights management set, which can be selected autonomously. The total rights set is a subset, and the user rights in the group cannot exceed the rights management set of the user group.

1.2.5 Storage Function

According to the user's configuration and policies (alarm or time settings), the corresponding audio and video data transmitted by the remote device is stored in the NVR device. For details, please refer to chapter Storage Management.

Users can record by WEB mode as needed. The video files are stored on the computer where the client is located. Please refer to chapter Storage.

1.2.6 Alarm Function

Real-time response to external alarm input, correct processing according to the user's preset linkage settings and give corresponding prompts.

The setting options of the central alarm receiving server are provided, so that the alarm information can be actively and remotely notified, and the alarm input can come from various external devices connected.

The alarm information can be notified to the user by mail or APP push information.

1.2.7 Network Monitoring

Through the network, the audio and video data of the IP camera or NVS (Network Video Server) of the NVR device is transmitted to the network terminal for decompression and reproduction.

The device supports 8 (or 4) simultaneous online users to perform streaming operations.

The audio and video data is transmitted using protocols such as HTTP (Hyper Text Transfer Protocol), TCP (Transmission Control Protocol), UDF (User Datagram Protocol), MULTICAST, RTP (Real-time Transport Protocol), and RTCP (Real Time Streaming Protocol).

Use SNMP (Simple Network Management Protocol) for some alarm data or information

Support WEB mode access system, applied to WAN, LAN environment.

1.2.8 Split Screen

Image compression and digitization are used to compress several images in the same scale and display them on the display of a monitor. 1/4/8/9/16/32 screen splitting is supported during preview; 1/4/9/16 screen splitting is supported during playback.

1.2.9 Recording Function

The device supports regular recording, motion detection recording, alarm recording, and intelligent recording. The recording file is placed on the hard disk device, USB (Universal Serial Bus) device, and client PC (personal computer). It can be connected to the WEB terminal, USB device, or local device. Query and play back the stored video files.

1.2.10 Backup Function

Support USB2.0 and eSATA video backup.

1.2.11 External Device Control

The peripheral control function is supported, and the control protocol and connection interface of each peripheral can be set as you need.

Support transparent data transmission of multiple interfaces, such as: RS232, RS485.

1.2.12 Accessibility

Supports video NTSL (Nation Television Standards Committee) system and PAL (Phase Alteration Line) system.

Supports system resource information and real-time display of running status.

Supports for logging recording.

Supports local GUI (Graphical User Interface) output and quick menu operation via mouse.

Supports playback of audio and video from remote IPC or NVS devices.



NOTE

For other functions, please see the following text.

2 Product Structure

2.1 Front Panel

Figure 2-1 One disk/four disks model

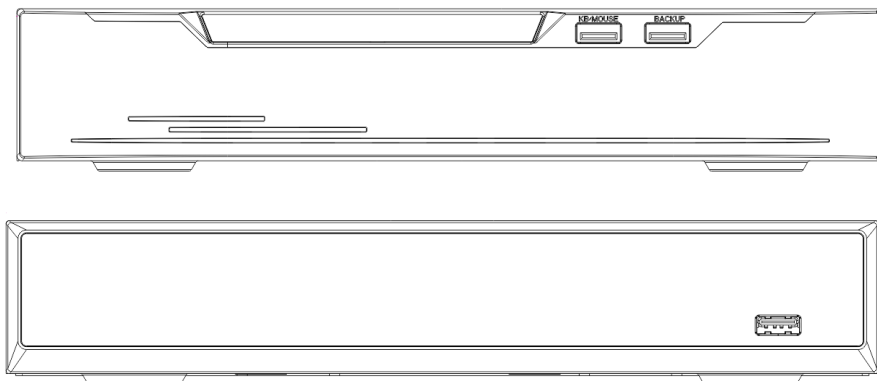

Table 2-1 Front panel function

Port	Description
PWR	When the NVR is operating, the PWR indicator is steady on. When the NVR is shut down, the PWR indicator is turned off.
HDD	Hard disk status indicator. This indicator flashes when data is transmitted.
POE	PoE network status indicator. This indicator flashes when data is transmitted.
KB/MOUSE	Only connected to an USB mouse.
BACKUP	Only connected to U disk.

Figure 2-2 One disk model

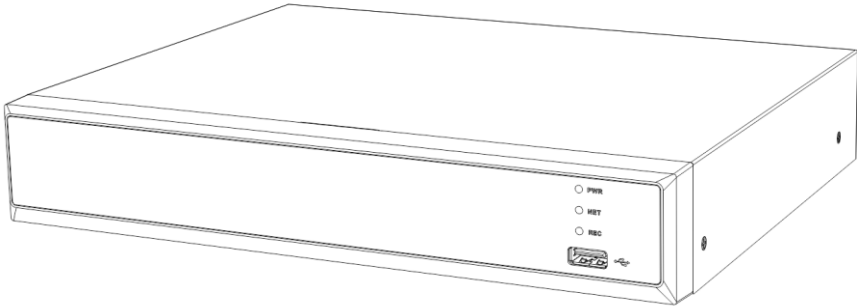

Table 2-2 Front panel function

Port	Description
PWR	When the NVR is operating, the PWR indicator is steady on. When the NVR is shut down, the PWR indicator is turned off.
NET	Network status indicator This indicator flashes when data is transmitted.
REC	Hard disk status indicator This indicator flashes when data is transmitted.
	Only connected to an USB mouse

Figure 2-3 Eight disk model



Table 2-3 Front panel function



Port	Description
PWR	When the NVR is operating, the PWR indicator is steady on. When the NVR is shut down, the PWR indicator is turned off.
HDD	Hard disk status indicator This indicator flashes when data is transmitted.
	Only connected to an USB mouse

Figure 2-4 WiFi model



Table 2-4 Front panel function

Port	Description
PWR	When the NVR is operating, the PWR indicator is steady on. When the NVR is shut down, the PWR indicator is turned off.
NET	Network status indicator This indicator flashes when data is transmitted.
REC	Hard disk status indicator This indicator flashes when data is transmitted.
	Only supports connected to an USB mouse

2.2 Back Panel

Figure 2-5 3704E1-P4

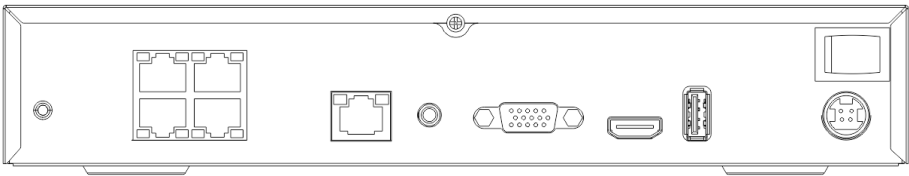

Figure 2-6 3804-E1-P4/3504E1-P4/3604E1-P4

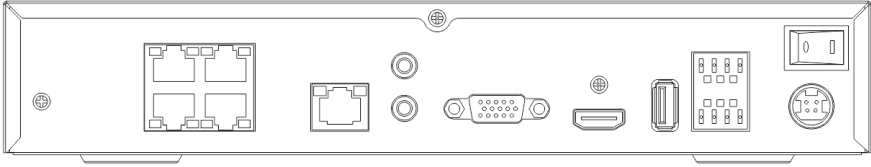

Figure 2-7 3808E1-P8E/3508E1-P8

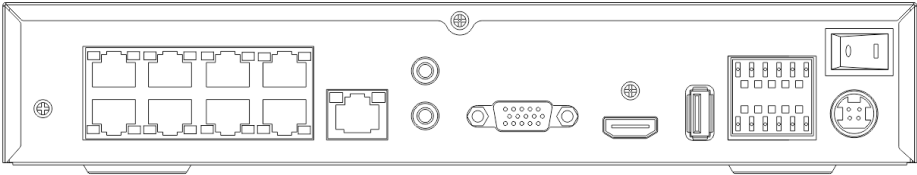

Table 2-5 Real panel function

Port	Description
POE	POE network interfaces
LAN	RJ 45 10/100/1000 Mbps adaptive Ethernet interface
AUDIO OUT / AUDIO IN	Audio output / Audio input
VGA	Video output interface
HDMI	
Alarm I/O	Alarm input/Alarm output
	GND
DC48V	Connected to an external power adapter

Figure 2-8 3632E4-P16

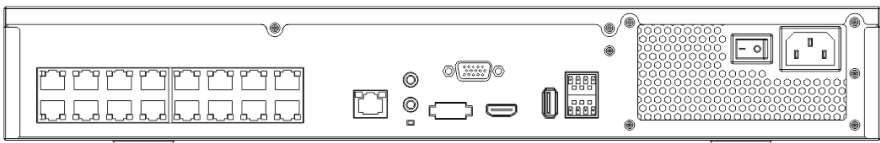

Figure 2-9 3816E2-P16/3516E2-P16/3532E2-P16

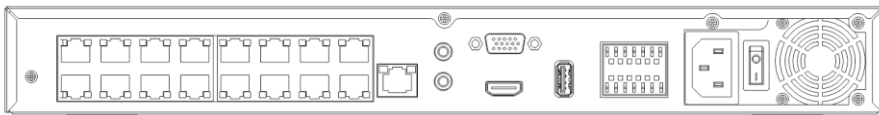

Table 2-6 Real panel function

Port	Description
POE	POE network interfaces
LAN	RJ 45 10/100/1000 Mbps adaptive Ethernet interface
AUDIO OUT / AUDIO IN	Audio output / Audio input
VGA	Video output interface
HDMI	
USB 3.0	Only connected to 3.0 U disk
Alarm I/O	Alarm input/Alarm output
	GND
DC48V	Connected to an external power adapter

Figure 2-10 3632E4/3664/E4

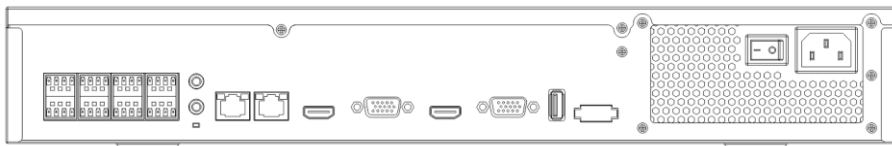

Figure 2-11 3632E8/3664E8

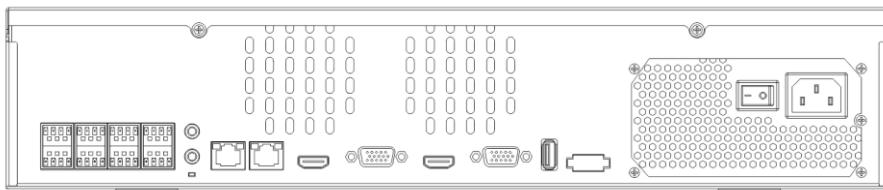

Table 2-7 Real panel function





Port	Description
	Alarm input and alarm output./RS485
LINE OUT / LINE IN	Audio output / Audio input
LAN1 /LAN2	RJ 45 10/100/1000 Mbps adaptive Ethernet interface. .LAN1 is deployed default gateway and used for external network. LAN2 is used for internal network.
VGA	Video output interface
HDMI (1/2)	
RS232	Standard RS232 serial communication interface of the device
USB 3.0	Only connected to 3.0 U disk
E SATA	External hard disk interface
	Power switch
	Safe ground screw of the device
	AC 110V/220V power input interface

Figure 2-12 2516E2/3816E2

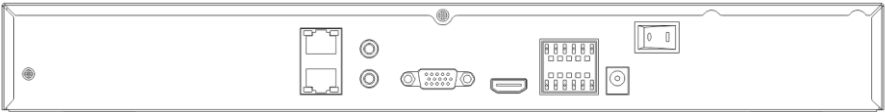

Figure 2-13 2504E1/2508E1/3804E1/3808E1

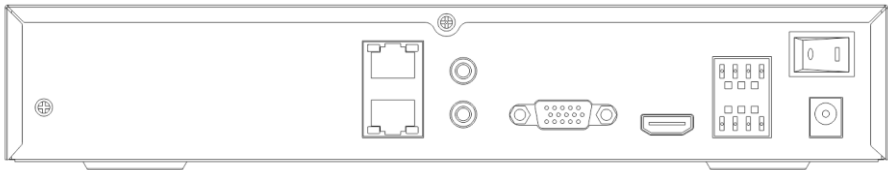

Table 2-8 Real panel function





Port	Description
	Alarm input and alarm output./RS485
LINE OUT / LINE IN	Audio output / Audio input
LAN	RJ 45 10/100/1000 Mbps adaptive Ethernet interface
VGA	Video output interface
HDMI	
RS232	Standard RS232 serial communication interface of the device
USB 3.0	Only connected to 3.0 U disk
E SATA	External hard disk interface
	Power switch
	Safe ground screw of the device
	Connected to an external power adapter

Figure 2-14 WiFi model

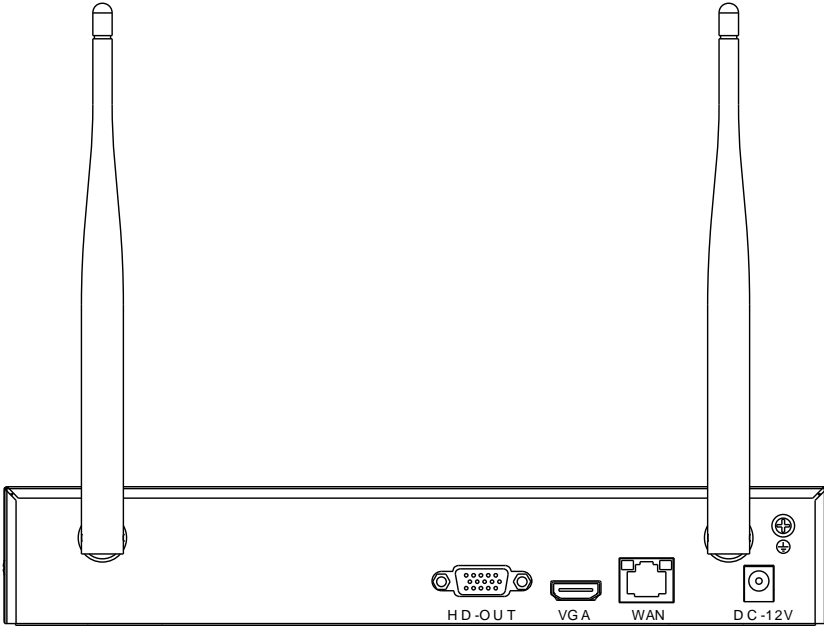

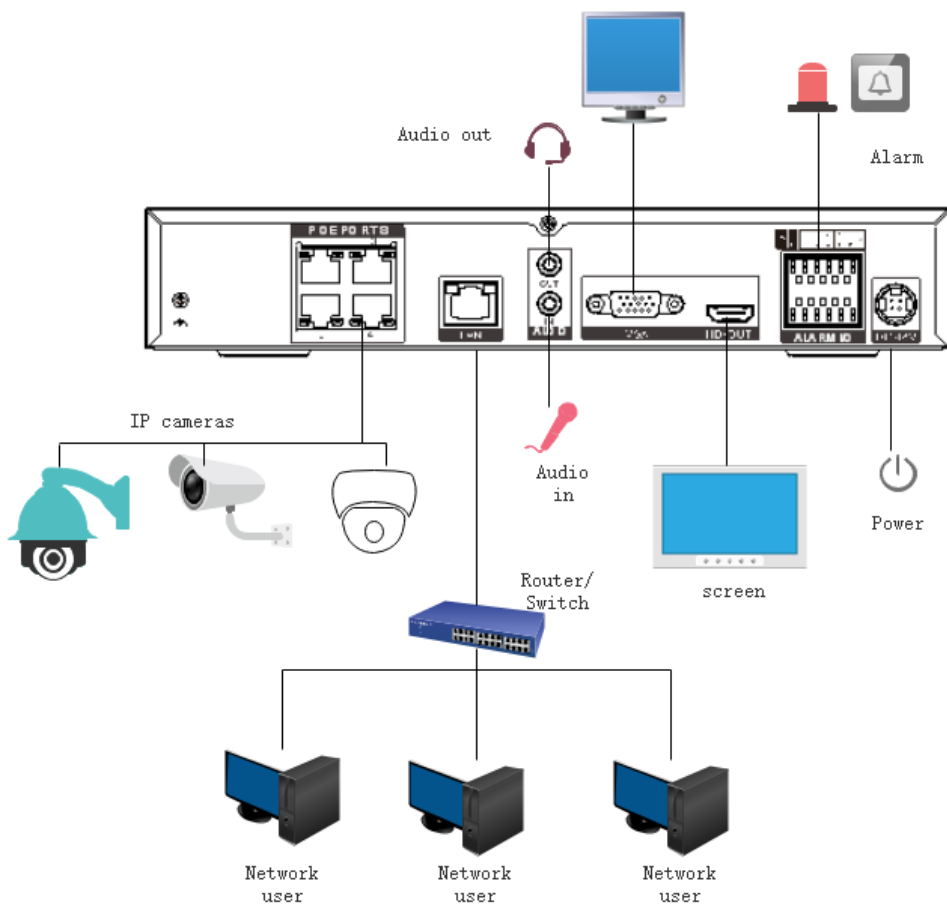
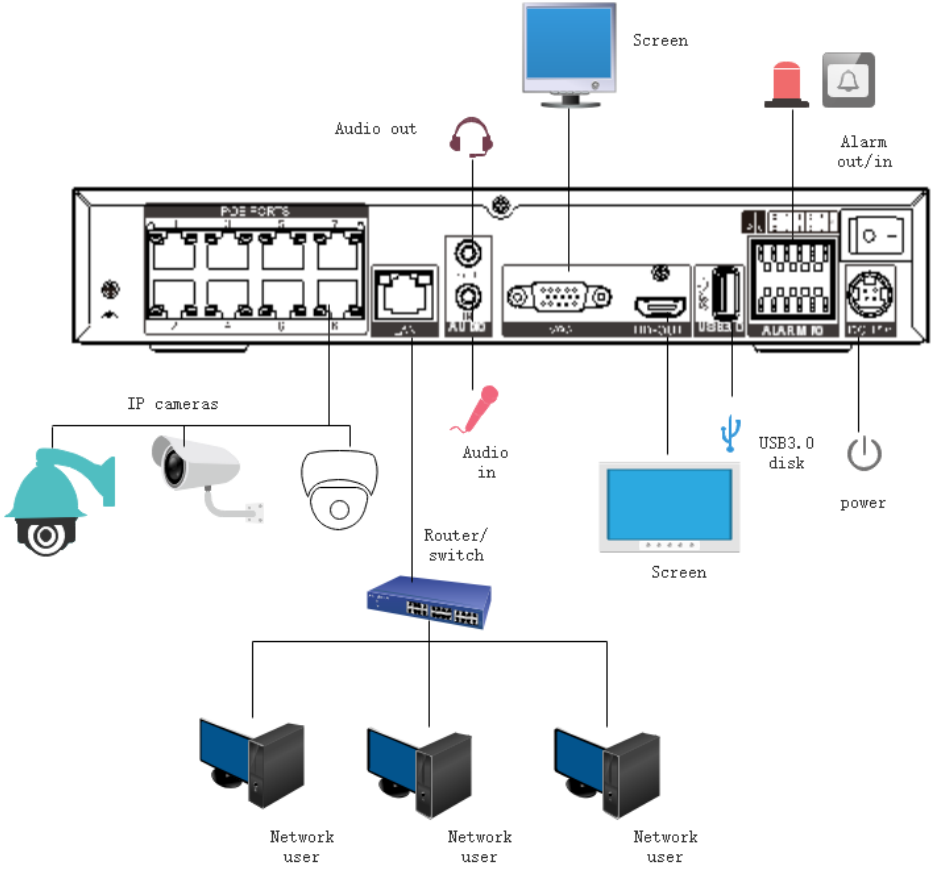
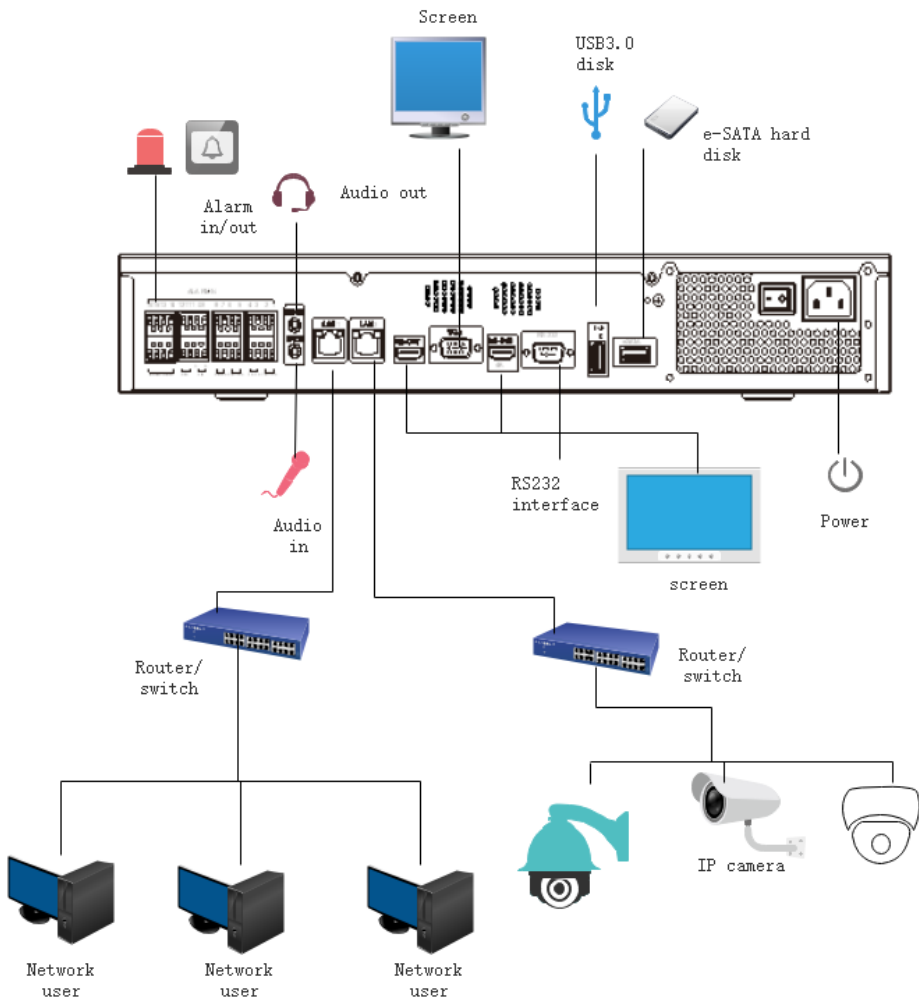

Table 2-9 Real panel function

Port	Description
WAN	RJ 45 10/100/1000 Mbps adaptive Ethernet interface
VGA	Video output interface
DC 12V	Connected to an external power adapter
	Safe ground screw of the device







2.3 Important Notes

Thank you for choosing the NVR. Please read the user manual carefully before using this product.

The NVR is a complex system-based device. To avoid misoperations and malfunctions caused by environmental factors and human factors during installation, commission, and application, note the following points when installing and using this product:

Read the user manual carefully before installing and using this product.

Use Monitoring dedicated hard disks as the storage devices of the NVR with high stability and competitive price/performance ratios (the quality of hard disks sold on markets varies greatly with different brands and models).

Do not open the enclosure of this product unless performed by a professional person to avoid damage and electric shock.

We are not liable for any video data loss caused by improper installation, configuration, operation, and hard disk errors.

All images in the document are for reference only, please subject to the actual products.

2.4 About This User Manual

Please note the following points before using this user manual:

This user manual is intended for persons who operate and use the NVR.

The information in this user manual applies to the full series NVR, NVR as an example for description.

Read this user manual carefully before using the NVR and follow the methods described in this manual when using the NVR.

If you have any doubts when using the NVR, contact your product seller.

As our products are subject to continuous improvement, we reserve the right to modify product manual, without notice and without incurring any obligation.

2.5 Installation Environment and Precautions

Installation environment

Table 2-10 defines the installation environment of the NVR.

Table 2-10 Installation environment

Item	Description
Electromagnetism	The NVR conforms to national standards of electromagnetic radiation and does not cause harm to the human body.
Temperature	-10°C to +45°C
Humidity	20% to 80%
Atmospheric pressure	86 Kpa to 106 Kpa
Power supply	DC 12V, DC 48V 2A(1 HDD) or AC110/ 220V 4A(2 HDDs or more), please refer to actual products.
Power consumption	<15W (not including the hard disk)

Installation precautions

Note the following points when installing and operating the NVR:

The power adapter of the NVR uses $DC48V \pm 20\%$ input. Do not use the NVR when voltage is too high or too low.

Install the NVR horizontally.

Avoid direct sunlight on the NVR and keep away from any heat sources and hot environments.

Connect the NVR to other devices correctly during installation.

The NVR is not configured with any hard disk upon delivery. Install one or more hard disks when using the NVR for the first time.

The NVR identifies hard disk capacity automatically and supports mainstream hard disk models. You'd better use high-quality hard disk so that the NVR can work stably and reliably. Please refer to chapter 10 Disk Compatibility

Other precautions

Clean the NVR with a piece of soft and dry cloth. Do not use chemical solvents.

Do not place objects on the NVR.

The NVR meets the national standards of electromagnetic radiation and does not cause electromagnetic radiation to the human body.

Series of NVR

3 Install device

3.1 Process

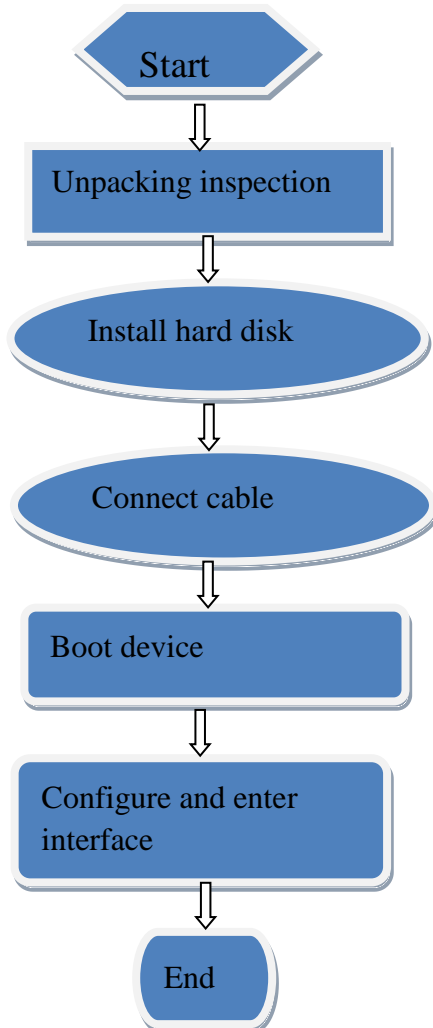

Install device



- Step 1 Check the appearance, packaging, and label of the device to make sure there is no damage.
- Step 2 Install the hard disk and fix it to the device bracket.
- Step 3 Connect the device cable.
- Step 4 Make sure the device is properly connected. Power up and turn on the device.
- Step 5 Configure the initial parameters of the device. The boot wizard contains network configuration, add cameras, and manage disks. For details, please refer to the chapter of Wizard .

3.2 Unpacking Inspection

When you receive the video recorder, please check it against the following table.

Should you have any issues, please don't hesitate to contact our after-sales support.

Table 3-1 Unpacking inspection

No	Item		Check content
1	Overall packaging	Appearance	Is there any obvious damage
		Package	Is there accidental impact
		Accessories	Is it complete
2	Label	Label of device	Is the equipment model consistent with the order contract? Whether the label is torn  NOTE Do not tear or discard, otherwise warranty service is not guaranteed. When you call the company for sales personnel calls, you need to provide the serial number of the product on the label.
3	Cabinet	Package	Is there any obvious damage
		Data cable, power cable, fan power supply, and motherboard	Is the connection loose?  NOTE If it is loose, please contact the company's after-sales personnel.

3.3 Install Hard Disk

Check if the hard disk is installed during the first installation. Please use the recommended hard disk model. For more details, see *10 Disk Compatibility*.

It is not recommended to use a PC dedicated hard disk.

 **CAUTION**

When replacing the hard disk, please turn off the power and then open the device to replace the hard disk.

Please use the monitoring dedicated SATA hard disk recommended by the hard disk manufacturer.

Choose the hard disk capacity according to the recording requirements.

3.3.1 Install One or Two Hard disks

Step 1 Remove the screws for fixing the upper cover and take down the cover.

Step 2 Take out the screws and silicone cushion, pass the screws through the silicone cushion, and secure it to the screw holes, as show in Figure 3-1..

Figure 3-1 Installing the hard disk screws

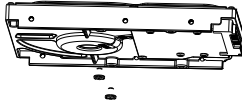

Step 3 Pass the screws through the holes on the base and put the hard disk in place, as shown in Figure 3-2.

Figure 3-2 Install hard disk

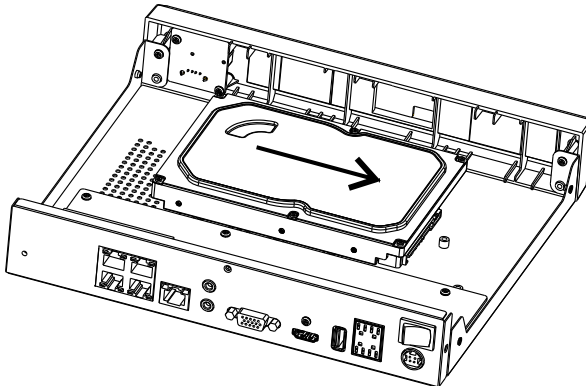

Step 4 Turn the device over, and fasten the fixing the rest 2 screws, as shown in Figure 3-3.

Figure 3-3 Install hard disk

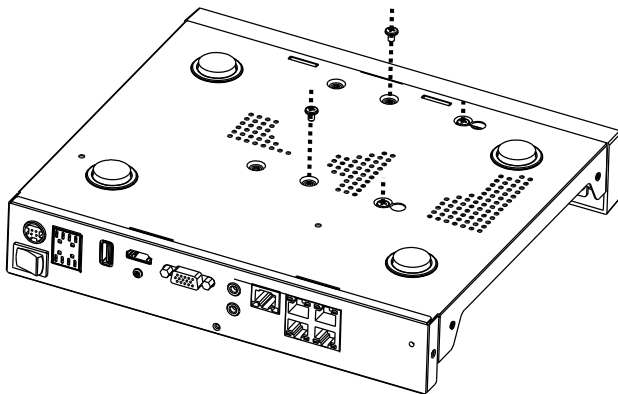

Step 5 Insert the hard disk data cable and power cable, then put back the upper cover and fasten the fixing screws.

3.3.2 Install Four Hard disks

Step 1 Remove the top cover by loosening the screws..

Step 2 Put the hard disk under the hard disk bracket, hold the hard disk with one hand and aim the hard disk hole at the bracket hole, and then tighten the screws to fix (first install the hard disk near the fan), as shown in Figure 3-4.

Figure 3-4 Installing the hard disks

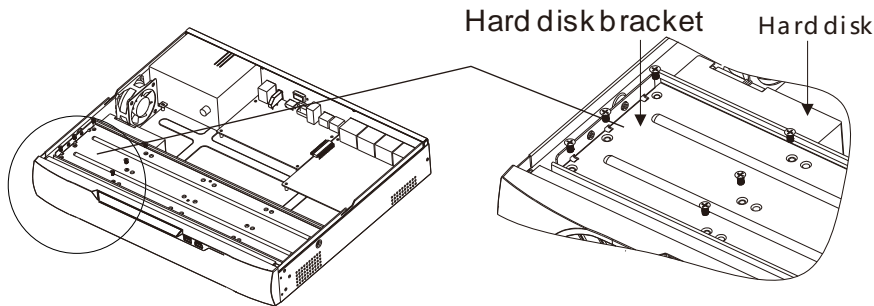

Step 3 Install other hard disks following step 2.

Step 4 Insert the hard disk data cable and power cable, and then put back the upper cover and tighten the fixing screws.

3.3.3 Install Eight Hard disks

Step 1 Remove the screws for fixing the upper cover and take down the cover.

Step 2 Loosen screws on both sides to lift the upper bracket as shown figure.

Figure 3-5 Loose screws lift the upper bracket

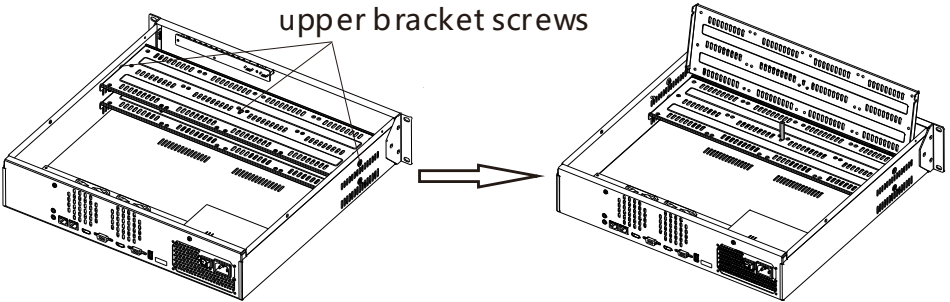

Step 3 Put the hard disk under the lower bracket, hold the hard disk with one hand and aim the hard disk hole at the bracket hole, then fix the screws for hard disk, as shown in Figure 3-6.

Step 4 Pull down the upper bracket and secure it by tightening the screws, then install other hard disks in upper layer following step 3, as shown in the right figure in Figure 3-6.

Figure 3-6 Unscrew the screws

lift the upper bracket

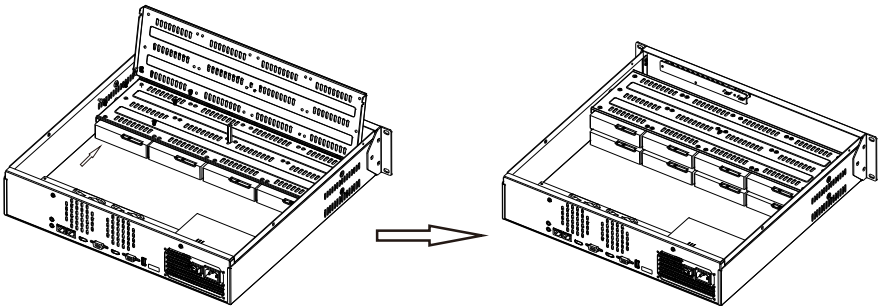

Step 5 Insert the hard disk data cable and power cable, then put back the upper cover and fasten the fixing screws.

4 Basic Operations

4.1 Power on the Device



CAUTION

Ensure that the NVR is correctly connected to a power supply, and a display is correctly connected to the high-definition multimedia interface (HDMI) or video graphics array (VGA) port of the NVR before power-on.

In some environments, abnormal power supply may cause the failure of the NVR to work properly and even damage the NVR in severe cases. It is recommended to use a regulated power supply to power up the NVR in such environments.

After connecting the NVR to a power supply, the power indicator is always on. Start the NVR.

The real-time video screen is displayed as shown in Figure 4-1.

Figure 4-1 Real-time video screen

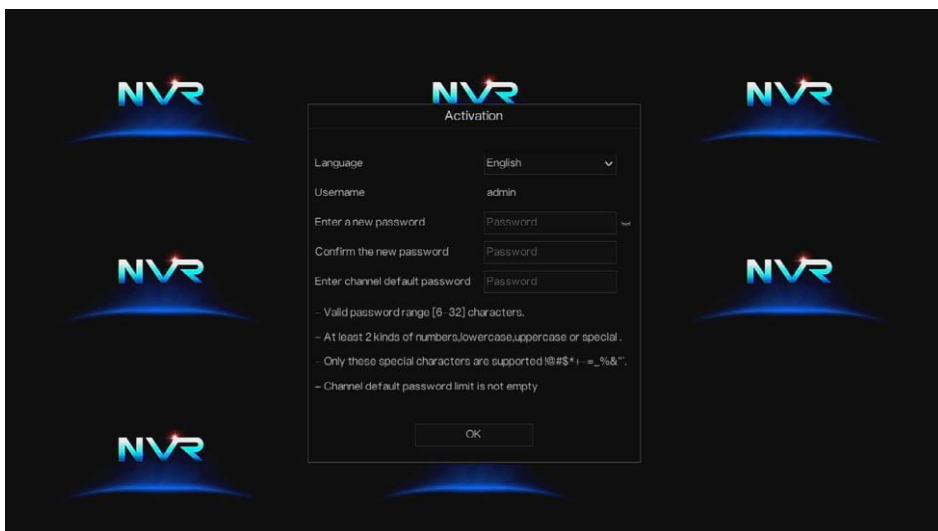

 **NOTE**

Users need to provide a hard disk for the NVR. The hard disk is strictly detected during device startup.

If the detection result failed, the possible causes are as follows.

The hard disk is new and is not formatted. Login to the system and format the hard disk.

The hard disk is formatted, but the file system is inconsistent with the file system supported by the NVR. Format the hard disk.

The hard disk is damaged.

4.2 Activation

When users log in the device at first time, or reset the NVR, you need to activate the device and set login and channel default password, as shown in Figure 4-2.

Figure 4-2 Activation

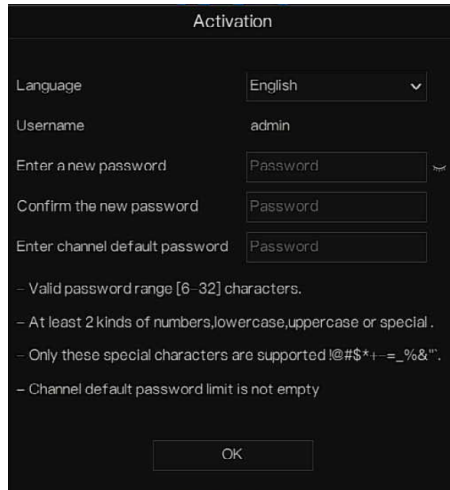

Table 4-1 Description of activation

Name	Description
Username	The default username is admin, and “admin” is super administrator.
Password	Valid password range 6-32 characters.
Confirm password	At least 2 kinds of numbers, lower case, upper case or special characters contained. Only these special characters are supported ! @#&*+ =- %&\'\"' data-bbox="65 725 936 900"/>

Channel password	The NVR channel connection password is the camera login password.
------------------	---

Users can set the pattern unlock to login the device, as shown in Figure 4-3.

Figure 4-3 Set pattern unlock

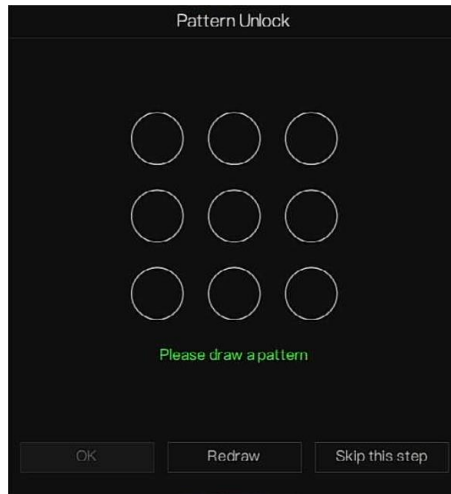

 **NOTE**

After setting pattern unlock, the system default login will be pattern unlock login. If pattern unlock is not set, you need enter the password to log in.

If you don't need to set the pattern to unlock, click "Skip this step".

Allow the Mailbox to receive verification code. The password will be reset when you forget it, as shown in Figure 4-4.

Figure 4-4 Set Email

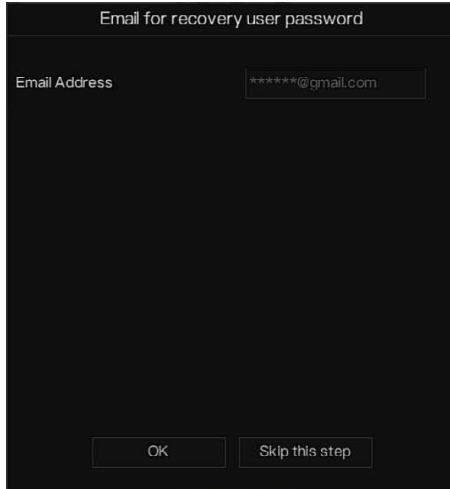

Email for recovery user password

Email Address *****@gmail.com

OK Skip this step

 **NOTE**

Set the email address, if you forget the password, you can through the email address to receive the verification, and reset the password.

If the email address is not set, you can reply to the secure question or send the QR code to the seller to get the temporary password to login to the device.

If you don't need to set the email, click "Skip this step".

Set the secure questions to create a new password in case the user forgets the password.

Figure 4-5 Set question

Question (Recovery the password)

Question one The brand and model of. ▾

Question one answer

Question two Your favorite team ▾

Question two answer

Question three Your favorite city ▾

Question three answer

- Please enter at least 1 characters for the answer

- Please enter up to 32 characters for the answer

OK Skip this step

 **NOTE**

The user can set three questions, and if they forget the password, they can answer the question and enter the reset password interface.

Questions one can be set: Your favorite animal

Company name of your first job

The name of the first boy/girl you like

The worst security question you have ever seen

The funniest worst design you have ever seen

Your favorite team

Your favorite city

The three question options cannot be set to the same issue.

The answer requires a minimum of four characters and a maximum of 32 characters.

If you do not want to set a password question, you can click Skip this step.

4.3 Power off the Device

Click the main menu and choose **System > Maintenance**, the maintenance setting page is displaying, click **Shutdown** to power off the NVR. If there is a power switch on the rear panel of the NVR, you can power off the power switch to disconnect the NVR from the power supply.

4.4 Login to the System

Step 1 Login to the device (two modes to login). The pattern unlock is as shown in Figure 4-6.

Figure 4-6 Pattern unlock login page



Step 2 On the NVR login page, click “Password” to enter pattern unlock interface. If users don’t set the pattern unlock it will show password to login interface directly, select the language, as shown in Figure 4-7.

Figure 4-7 Password login page

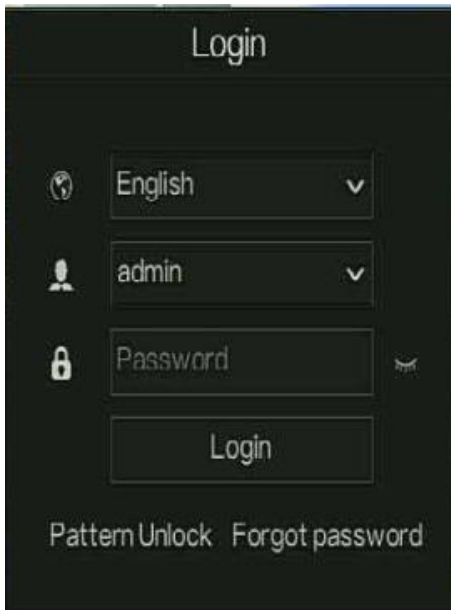

Step 3 Input the username and password.

 **NOTE**

The password incorrect more than 3 times, please login again after 5 minutes. You can also power off, and power on to start on the device, input the correct password to avoid waiting five minutes. If user forget password, click Forgot password. User can choose a way to create new password:

1. Scan the QR code and send the QR code to your seller, the seller will send you the verification code to create a new password.
2. Answer the secure question to create new password.

Step 4 Click Login to access the main User Interface (UI). Modify the default password, as shown in Figure 4-8

Figure 4-8 Modify default password

The screenshot shows a web interface titled "Modify default password". It contains two text input fields: "New password" and "Confirm password". Below the fields is a button labeled "Modify password". At the bottom, there are three bullet points detailing password requirements:

- Valid password range [6-32] characters.
- At least 2 kinds of numbers, lowercase, uppercase or special character contained.
- Only special characters are supported !@#\$*+=- _

----End

5 Wizard

Login the NVR, the wizard is showing on live video, click **Start Wizard**, the pop-up window will show as Figure 5-1.

Figure 5-1 Wizard

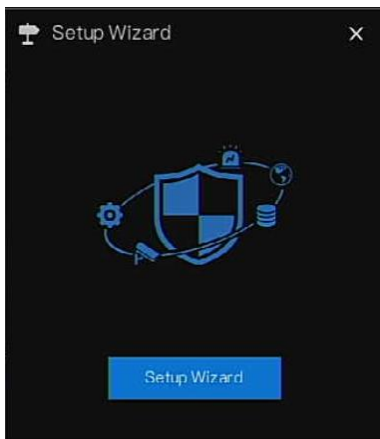
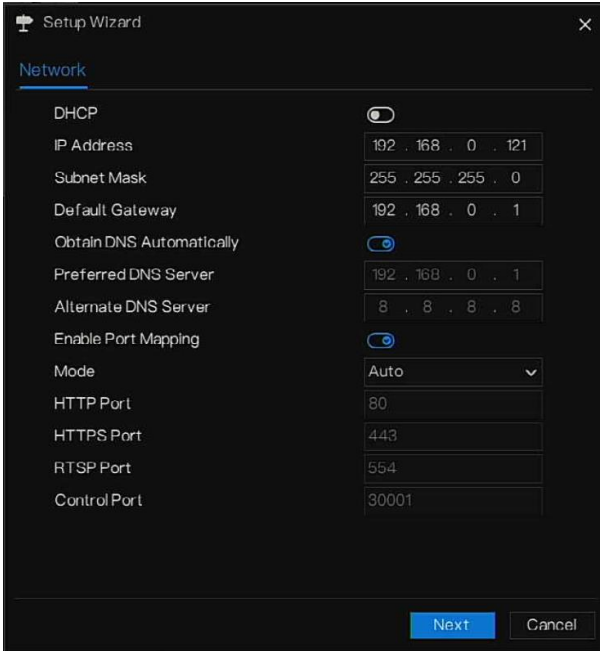

Figure 5-2 Wizard of network



Step 1 Contains the parameter, the details please refer to Table 5-1.

Table 5-1 Network parameter

Parameter	Description	Configuration
DHCP	Enable DHCP, the device will obtain the IP address from the DHCP server.	[Setting method] Enable
IP Address	Set the IP of device when DHCP is disabled	[Setting method] Manual
Subnet mask	Set the subnet mask of device	[Setting method] Manual [Default value] 255.255.255.0
Gateway	If the user wants to access device, he must set that	[Setting method] Manual [Default value] 192.168.0.1
Obtain DNS	N/A	[Setting method]

Parameter	Description	Configuration
automatically		Enable
Preferred DNS Server	N/A	[Setting method] Manual [Default value] 192.168.0.1
Alternate DNS Server	N/A	[Setting method] Manual [Default value] 8.8.8.8
Enable Port Mapping	Enable to set the ports of HTTP, HTTPS, RSTP, Control. Auto: device to obtain Web port, data port and client port. Manual: user set the port manually.	[Setting method] Choose type from drop-down list [Default value] Auto
HTTP Port	N/A	[Setting method]
HTTPS Port	N/A	When Port Mapping is manual, you need to set these.
RTSP Port	N/A	
Control Port	N/A	

Step 2 Click [Next](#) to view the basic information about device, as shown in Figure 5-3.

Figure 5-3 Wizard of date and time

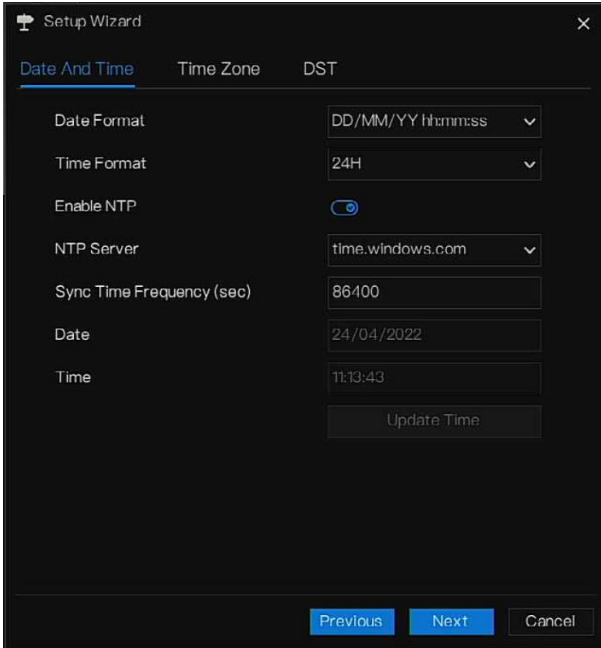

Choose date format and time format from drop-down list.

Click  to synchrony time from network.

Disable the NTP-Sync, set time manually.

Roll the mouse to choose year, month and day when clicking the date.

Roll the mouse to choose hour, minute and second when clicking the date.

Click **Modify Time** to save the time.

Step 3 Click **Time Zone**, choose the current time zone from drop-down list, as shown in Figure 5-4.

Figure 5-4 Wizard of time zone

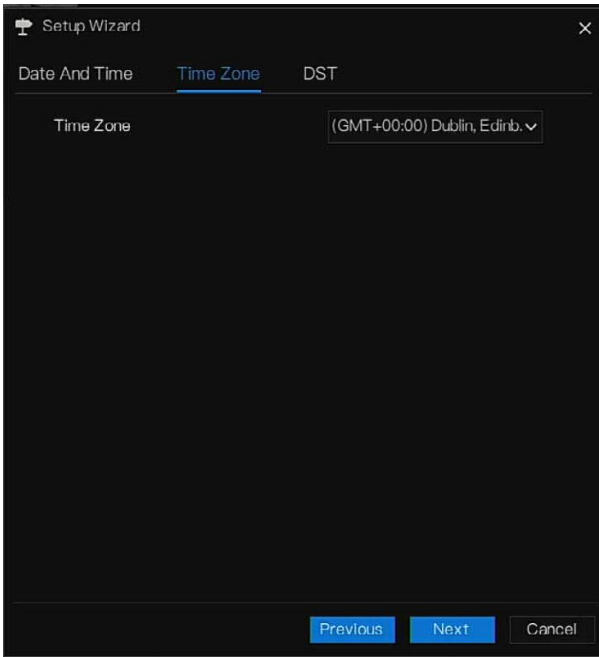

Step 4 Click **DST**, enable the DST, set start and end time. Select offset time from drop-down list.

Step 5 Click **Next** to enter the adding camera wizard, as shown in Figure 5-5.

Figure 5-5 Wizard of adding camera

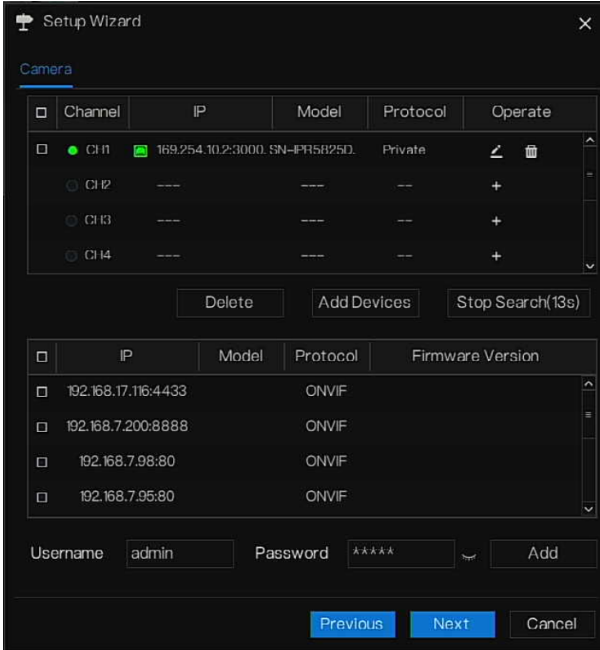

The details of adding camera please refer to *chapter 7.1*.

Step 6 Click to enter wizard of disk, as shown in Figure 5-6.

Figure 5-6 Wizard of disk

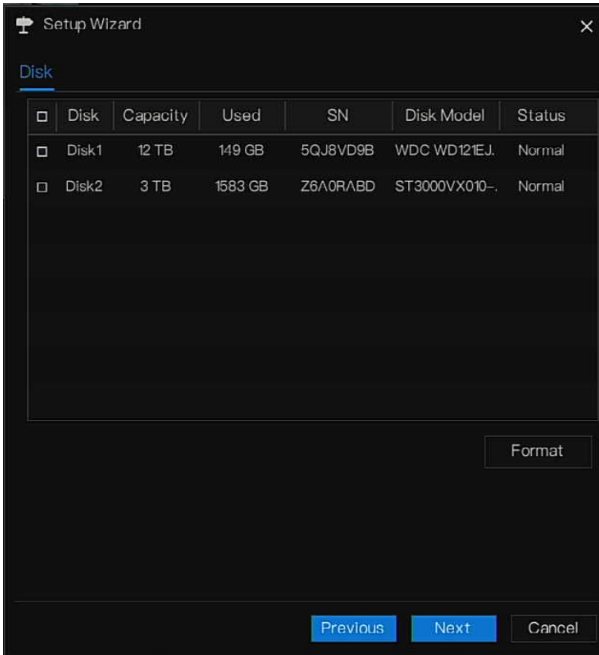

You can view the general information of disk. You can also format the disk.

Step 7 Click **Next** to enter wizard of P2P, as shown in Figure 5-7

Figure 5-7 P2P

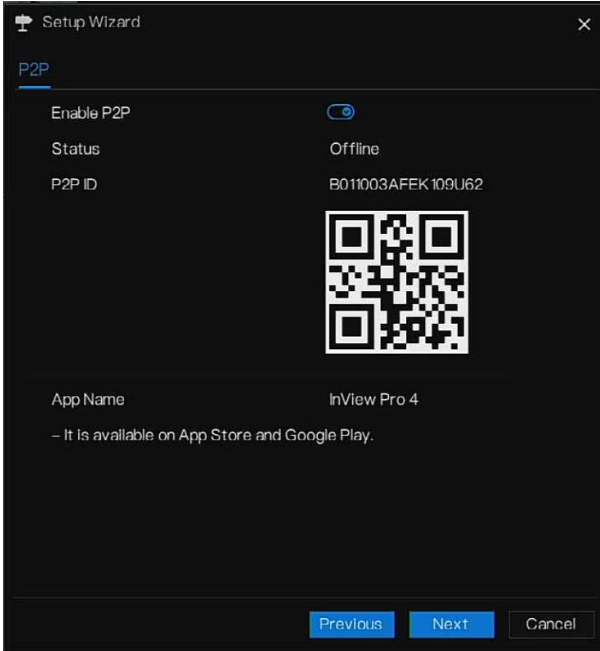

Step 8 Enable the P2P, user can use mobile devices to manage the NVR by scanning the P2P ID, if the mobile phone has loaded the InView Pro 4(search the APP at App Store or Google Play).

Step 9 Click **Next** to enter the wizard of resolution, as shown in Figure 5-8. Choose resolution from drop-down list. (the highest resolution is 3840*2160)

Figure 5-8 Wizard of resolution

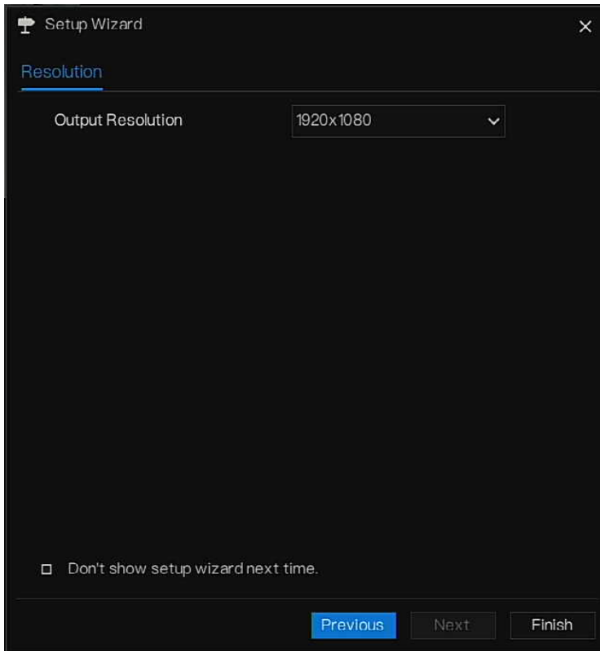

Step 10 Click **Finish** to end the wizard, tick the **Don't show setup wizard next time**, it would not show at next time. Reopen wizard at **system > User > Advance setting**.

6 Quick Navigation

6.1 Quick Bar

After the NVR operation screen is displaying, move the cursor to the far bottom of the NVR screen. The NVR floating menu bar is displaying.

Click  in the left of NVR floating menu bar. The quick home menu is showing. The quick home menu contains **Playback, System and Power (Shutdown, Reboot and Logout)** as shown in Figure 6-1.

Figure 6-1 Quick home menu



In the middle of NVR floating menu bar, the video tool bar provides **video window switching**, **auto SEQ**, **volume**, **playback**, and **channel information**, as shown in Figure 6-2.

Figure 6-2 Real-time video toolbar

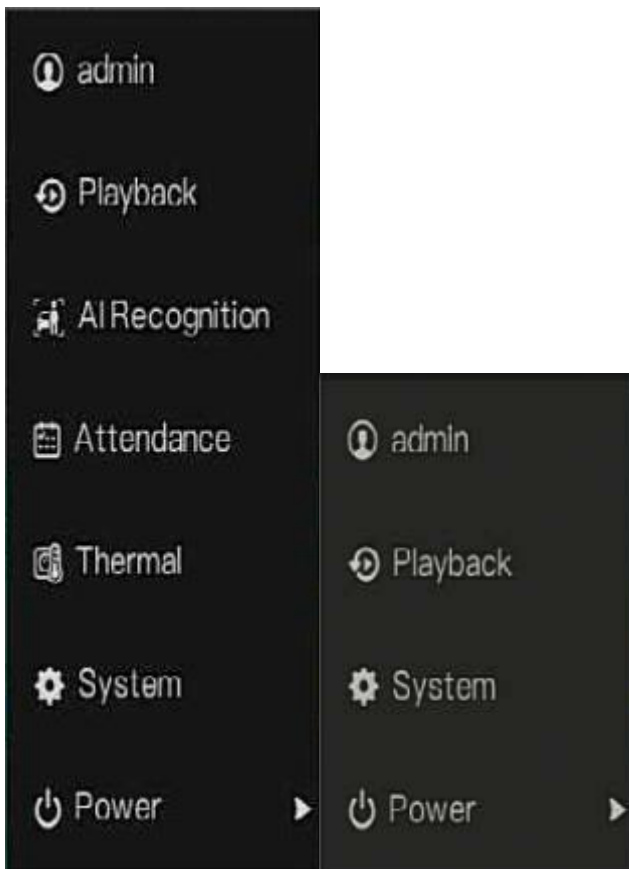

The real-time video toolbar is as follows:

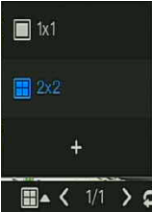

Layout. Users can choose layout and add new layout strategies as shown in

Figure 6-3. Click  on the right of screen splitting format and choose the channels to view the video. Click + to add a new layout.

Figure 6-3 Add layout



Input the layout name, choose the dwell time, choose the splitting format. Choose one channel or several channels to add on screen.

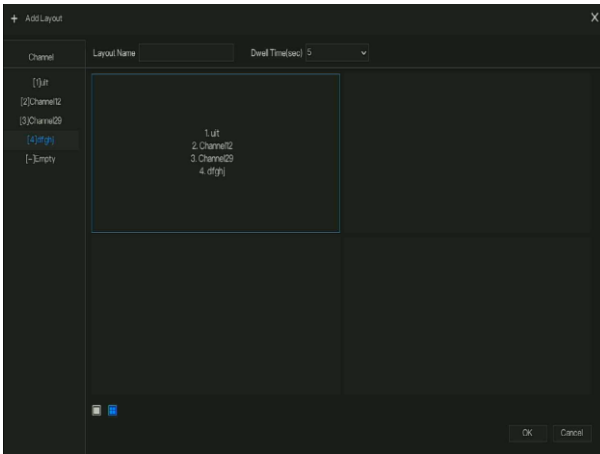

: Auto SEQ. click icon, the layout dwell on screen is enabled, for how to set the dwell on, please see *chapter 7.5.5*.



: Audio. Click on the icon, the audio setting screen is displaying, where you can choose the channel and adjust the volume.



: Channel information, tick the channel or encode, the live video will show the channel information.

Quick Navigation



: Preview strategy, users can switch the real-time preview mode according to the network.

There are three modes: fluency, balanced and real-time.

A main menu quick toolbar is on the right of NVR floating menu bar. The main menu quick toolbar provides **Manual alarm, Alarm information, Clean alarm, Information** and **time**, as shown in Figure 6-4.

Figure 6-4 Main menu quick toolbar



: Manual alarm, click the icon, users can set different channels, choose alarm out, the window shows in Figure 6-5.

Figure 6-5 Manual alarm



: Alarm message, click on the icon for more details as shown in Figure 6-6.

Figure 6-6 Alarm message

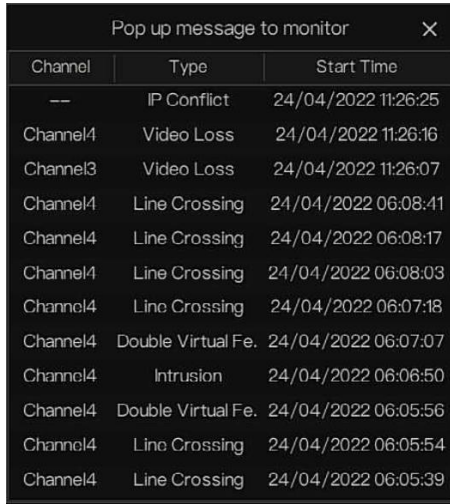

Channel	Type	Start Time
--	IP Conflict	24/04/2022 11:26:25
Channel4	Video Loss	24/04/2022 11:26:16
Channel3	Video Loss	24/04/2022 11:26:07
Channel4	Line Crossing	24/04/2022 06:08:41
Channel4	Line Crossing	24/04/2022 06:08:17
Channel4	Line Crossing	24/04/2022 06:08:03
Channel4	Line Crossing	24/04/2022 06:07:18
Channel4	Double Virtual Fe.	24/04/2022 06:07:07
Channel4	Intrusion	24/04/2022 06:06:50
Channel4	Double Virtual Fe.	24/04/2022 06:05:56
Channel4	Line Crossing	24/04/2022 06:05:54
Channel4	Line Crossing	24/04/2022 06:05:39



: Clean alarm, click icon and clean the current alarm actions like voice and external alarm out.



: Information, click icon and the general information would show, like network, system, channel, disk and alarm, as shown in Figure 6-7.

Figure 6-7 Information

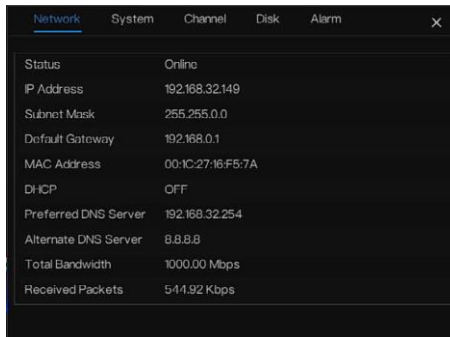

Network	System	Channel	Disk	Alarm
Status	Online			
IP Address	192.168.32.149			
Subnet Mask	255.255.0.0			
Default Gateway	192.168.0.1			
MAC Address	00:1C:27:16:F5:7A			
DHCP	OFF			
Preferred DNS Server	192.168.32.254			
Alternate DNS Server	8.8.8.8			
Total Bandwidth	1000.00 Mbps			
Received Packets	544.92 Kbps			

6.2 Real Time Video Bar

Right click at realtime image, the quick setting will show as figure.



Record: click the icon and start to record video. Click again to end record.

Instant playback: click the icon, the window will be recording video five minutes ago.

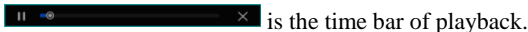

is the time bar of playback.

Audio: open or close the audio.

PTZ: This function is only applied for speed dome cameras. The monitored camera can focus, zoom or iris at this pop-up window. You can adjust every parameter as shown in Figure 6-8.

Figure 6-8 PTZ adjust screen



: adjust direction of camera.



: At this part, perform **Advanced**, **Scan** and **Tour** settings.



: 3D, this function can only be used for high speed dome camera. Click the icon to enter the camera live video screen, use the mouse to move the camera or zoom in or out the lens. Click the point to zoom in. Drag and draw the area, zoom in the drawing area, Reverse drag to zoom out.



: Zoom in, click zoom in, roll the mouse wheel to zoom in and zoom out. Right-click to exit the zooming.



: Image, click the icon, as shown in Figure 6-9. Select scene, and drag cursor to adjust value of brightness, sharpness, contrast and saturation.

Figure 6-9 Camera picture parameter

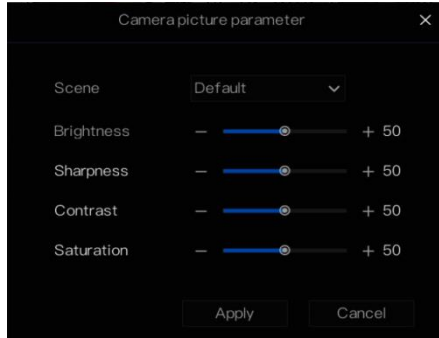

: Two way audio. The NVR and camera can talk to each other.



: Snapshot panorama. If an USB storage device is connected to the NVR device, click to save the panorama snapshot directly.



: fisheye (only used for fisheye cameras), click to switch the fisheye modes, as shown in

Figure 6-10.

Figure 6-10 Fisheye

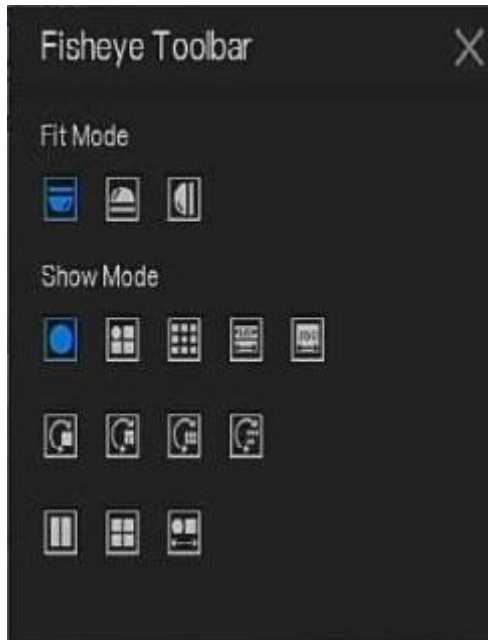

6.3 Playback

Playback refers to playing back a video, fixed-point playback, playback the search type.

Click  in the quick navigation bar to access the playback screen, as shown in Figure 6-11.

Figure 6-11 Playback screen



Choose the channels from the channels list, click one day to play (the date has blue line, it means there is recording video at this day, it doesn't mean for all channels has video.)

It maybe has three color bars on the time bar, the blue one is schedule record, the yellow one is manual record, and the red one is alarm record.

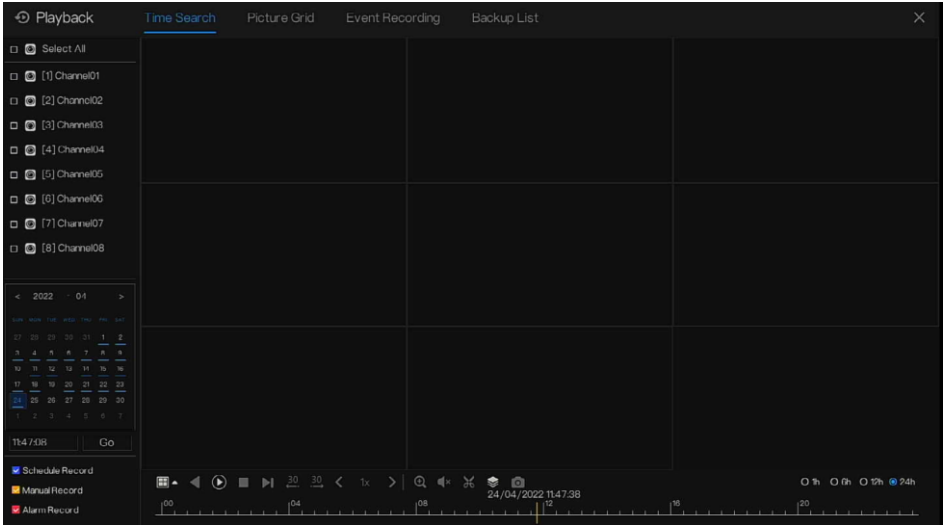
The toolbar at the bottom of the playback screen is described as follows:



 : Layout.

 : Reversed, pause/play, stop.

 :30s backward, 30s forward.

 : Triple speed, it supports up to 32 times to playback. Click the Number to switch the speed.

 : Zoom. Roll the roller of mouse to zoom in or out.

Quick Navigation

: Audio.

: Start and end backup. Click the icon, the video backup starts, select the video and click the icon again.

The backup type appears. Click **save**. And **saving the file** pop ups as Figure 6-12. Click **OK** to save.

This function is available after an USB disk is plugging in the device.

Figure 6-12 Select directory

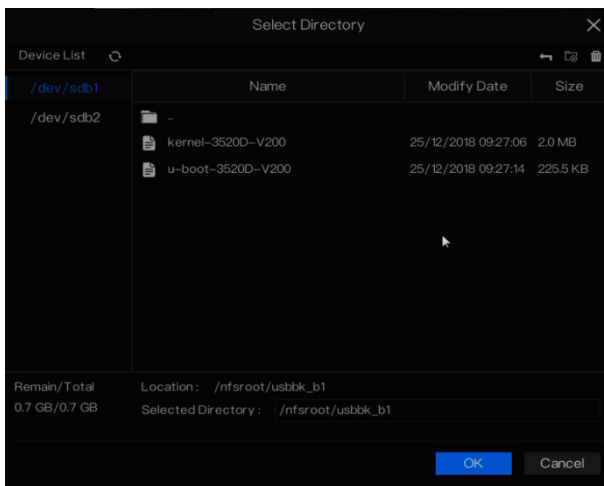

: Batch backup, click the icon to backup multi-channels, as shown in Figure 6-13.

Choose the folder to save, select the stream information from drop-down list, set the start time and end time, select the channels, Click **OK** to backup. The backup videos are marked by watermark, you can view it by our player.

: Snapshot panorama. Click to save it to USB storage device on NVR.

Figure 6-13 Batch backup



: Type of time bar, recording video can show

6.3.1 Time Search

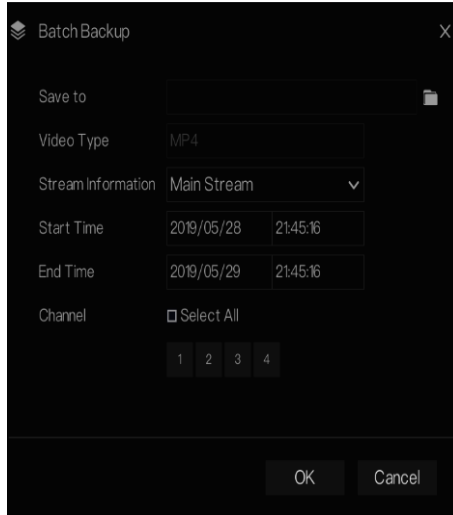
Search refers to searching for a video by date and time.

Operation Description

Click  in the quick navigation bar to access the search screen, as shown in Figure 6-14.

Figure 6-14 Time Search screen



Operation Steps

- Step 1 Select a camera or cameras in the camera list on the left side of the search screen. The video view of the selected camera is displaying in the play window.
- Step 2 Select a date in the calendar on the light-down side of the search screen.
- Step 3 Choose record type, and search the video quickly.
- Step 4 Choose proper button to adjust video.

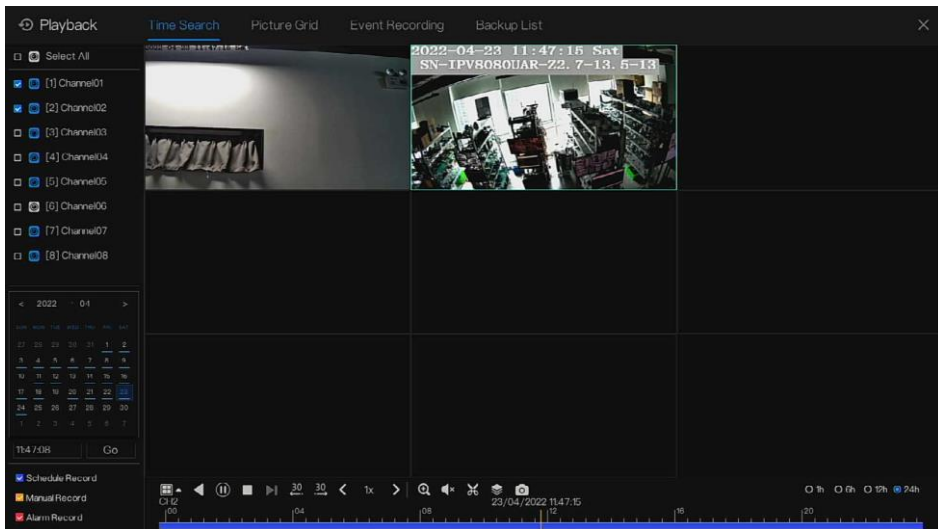
----End

6.3.2 Picture Grid

Picture grid refers to evenly dividing the video of a channel by time range and searching for a video based on thumbnails divided by time range.

Click **Picture Grid** on the quick navigation bar to access the picture grid screen, as shown in Figure 6-15.

Figure 6-15 Picture grid screen

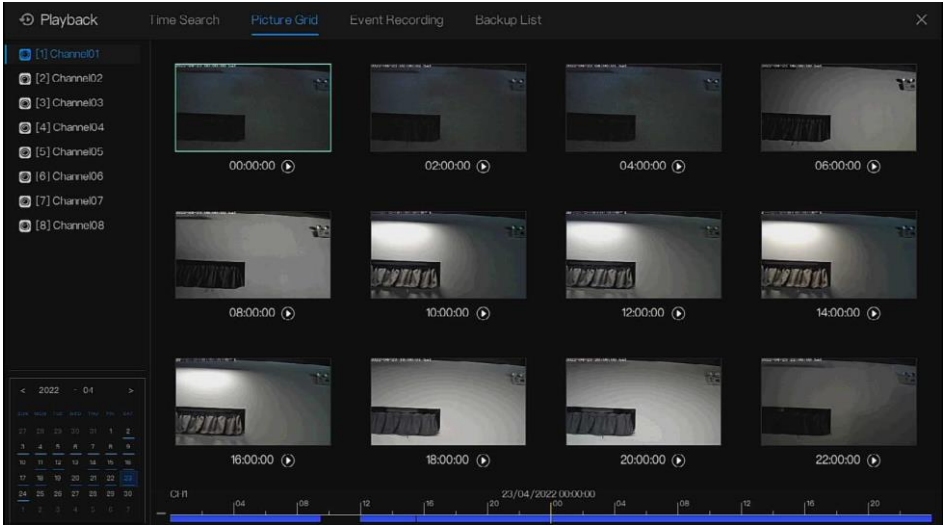

Operation Steps

- Step 1 Select a camera in the camera list on the left side of the picture grid screen. Videos shot by the camera in the earliest time range on the current day are displayed as thumbnails in the window on the right side.
- Step 2 Select a date from calendar.
- Step 3 A day are dividend to 12 grids, every two hours is a grid. Click the image to change the interval.
- Step 4 Select a required thumbnail, double-click it or right-click it and choose Play from the shortcut menu to play the video.
- Step 5 Click  to replay the gird individually.

Figure 6-16 Replay



----End

6.3.3 Event Recording

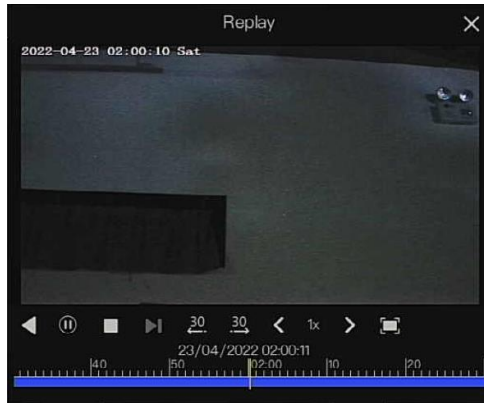

Click  on the quick navigation bar; choose **Event** at title to access the alarm event screen, as shown in Figure 6-17

Figure 6-17 Event screen

ID	Start Time	Channel	Type	Information	Operate
1	24/04/2022 11:47:38	Channel05	Motion Detection	Channel05	⏮ ⏭
2	24/04/2022 11:46:44	Channel03	Video Loss	Channel03	⏮ ⏭
3	24/04/2022 11:46:43	Channel04	Video Loss	Channel04	⏮ ⏭
4	24/04/2022 11:46:05	Channel04	Video Loss	Channel04	⏮ ⏭
5	24/04/2022 11:45:41	Channel03	Video Loss	Channel03	⏮ ⏭
6	24/04/2022 11:45:17	Channel05	Motion Detection	Channel05	⏮ ⏭
7	24/04/2022 11:44:38	Channel03	Video Loss	Channel03	⏮ ⏭
8	24/04/2022 11:43:57	Channel05	Motion Detection	Channel05	⏮ ⏭
9	24/04/2022 11:43:50	Channel03	Video Loss	Channel03	⏮ ⏭
10	24/04/2022 11:36:45	Channel05	Video Loss	Channel05	⏮ ⏭
11	24/04/2022 11:26:25	--	IP Conflict	IP Conflict	⏮ ⏭
12	24/04/2022 11:26:10	Channel04	Video Loss	Channel04	⏮ ⏭
13	24/04/2022 11:26:07	Channel03	Video Loss	Channel03	⏮ ⏭
14	24/04/2022 06:08:41	Channel04	Line Crossing	SN-IPR8080ALAN-22.7-13.5-23	⏮ ⏭
15	24/04/2022 06:08:17	Channel04	Line Crossing	SN-IPR8080ALAN-22.7-13.5-23	⏮ ⏭
16	24/04/2022 06:08:03	Channel04	Line Crossing	SN-IPR8080ALAN-22.7-13.5-23	⏮ ⏭

Operation Steps

- Step 1 Select cameras in the camera list on the left.
- Step 2 Set start and end time.
- Step 3 Tick the alarm type, such as alarm in, camera alarm in, motion alarm, video loss, intelligent analysis and abnormal alarm
- Step 4 Click **Search** to query the event, the result would show at window.
- Step 5 Double click to play video about event. It will play recording video.

: play the recording video.

: backup the recording video.

Quick Navigation

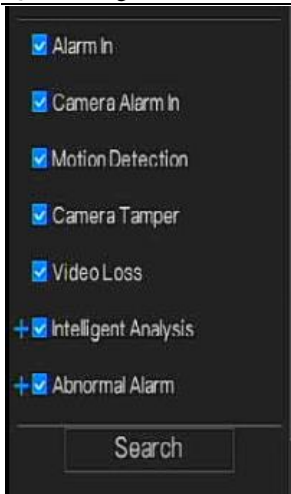

the type of intelligent analysis and abnormal alarm are subdivided, users can tick **Detail Alarm** to show.

Intelligent analysis includes perimeter, single virtual fence, double virtual fences, loiter, multi loiter, object left, object removed, abnormal speed, converse, illegal parking, signal bad, register, stranger, registered license plate, over temperature, low temperature, abnormal temperature, threshold warning, threshold alarm, temperature difference warning, temperature difference alarm, temperature section alarm, face temperature, wear mask, no mask, personnel count threshold alarm, personnel count threshold alarm(IPC) .

Abnormal alarm includes disk error, IP conflict, network disconnected.

User can choose the accurate alarm events to search.

----End

6.3.4 Backup List

Click  on the quick navigation bar, choose  at title to access the backup screen, as shown in Figure 6-18.

Figure 6-18 Backup screen



View detailed information of backup. Click on **Delete** to quit the download.

----End

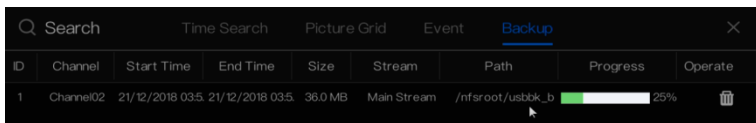
6.4 AI Recognition (Only for Some Models)

At AI recognition interface, we can set the **Real time Comparison, Smart search, Archives library, Comparison configuration.**

The all snapshots is able to be added to the libraries according the real needs

6.4.1 Real Time Comparison

Real time comparison can compare human faces, vehicle license plate, and AI(include riding, vehicle, full body)

6.4.1.1 Human Face



At real time comparison interface, click the  to enter the human face comparison interface, choose the cameras with face recognition function to play live video, the snapshots of camera will be compared with the templates which have been registered in libraries, the result shows as in Figure 6-19.

Figure 6-19 Human face comparison

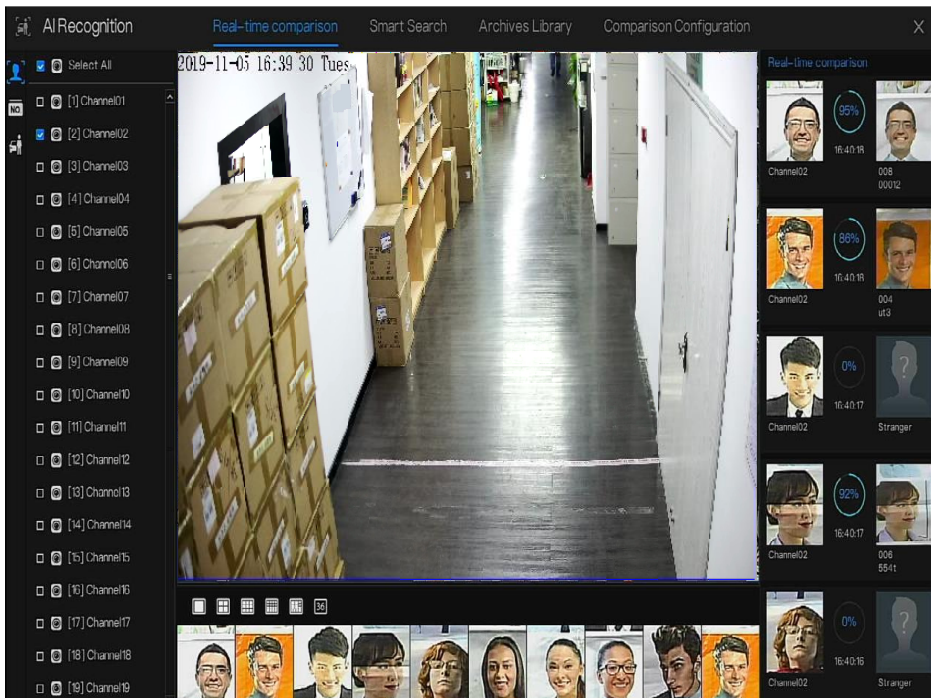

Click the “+” to add the snapshot to face library immediately.

Snapshot in real time video, put the cursor on picture such as , you can add it to face library, or face search. The cursor on area and the pictures are not update, move the mouse so that the pictures can be shown in time.

----End

6.4.1.2 Vehicle License Plate

At real time comparison interface, click the  to enter the vehicle license plate comparison interface, choose the cameras with license plate recognition function to play live video, the snapshot of camera will be compared with libraries, the result shows as in Figure 6-20.

Figure 6-20 Vehicle license plate



Click the “+” to add the snapshot to license plate library immediately.

----End

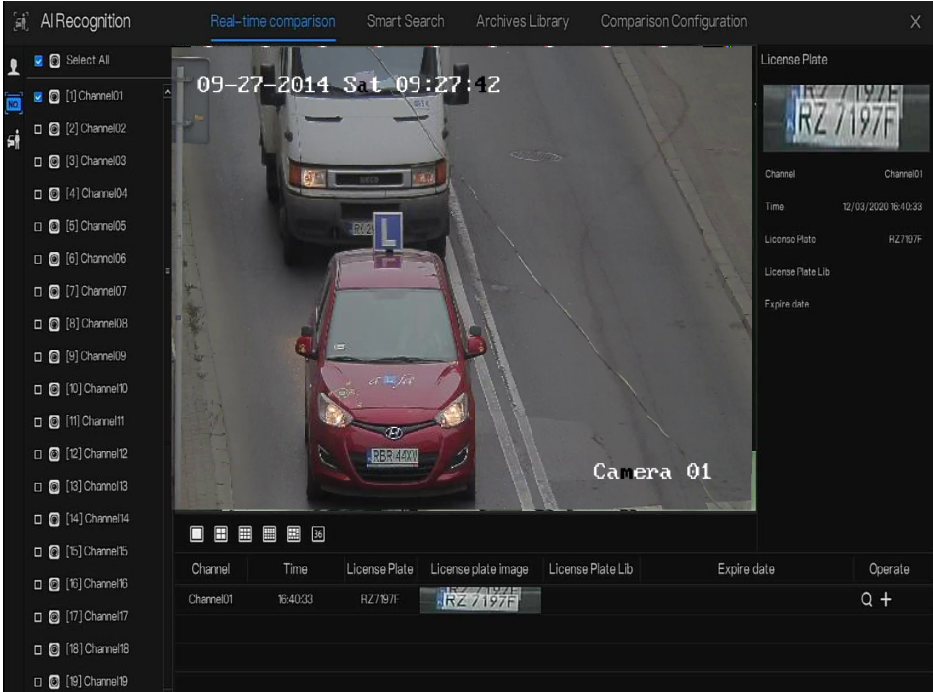
6.4.1.3 Vehicle and Full Body

At real time comparison interface, click the **NO** to enter the vehicle license plate comparison interface, choose the AI recognition cameras to play live video, the snapshot of camera will be compared in libraries, the snapshot to vehicle and full body will show at the bottom of page, the result shows as in Figure 6-21.

Figure 6-21 Full body

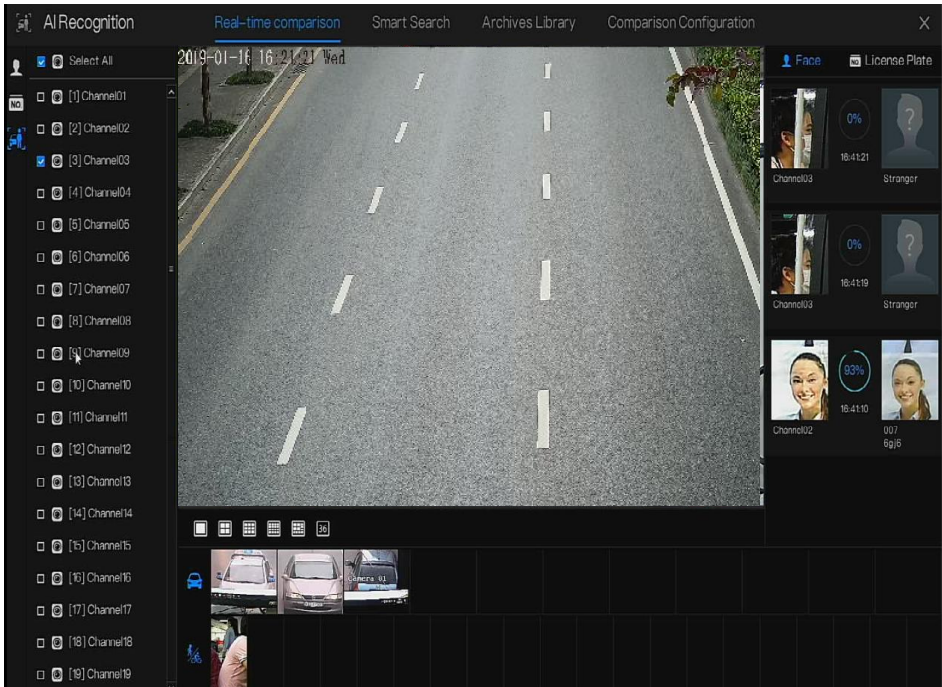

----End

6.4.1.4 Real-time Body Temperature Filter

At AI recognition, click  to enter the real-time body temperature filter. Users can select the body temperature camera, which will display temperature recordings and over-temperature snapshots. Click full-screen, the channel list and snapshots statistics will be hidden.

Figure 6-22 Real-time body temperature filter

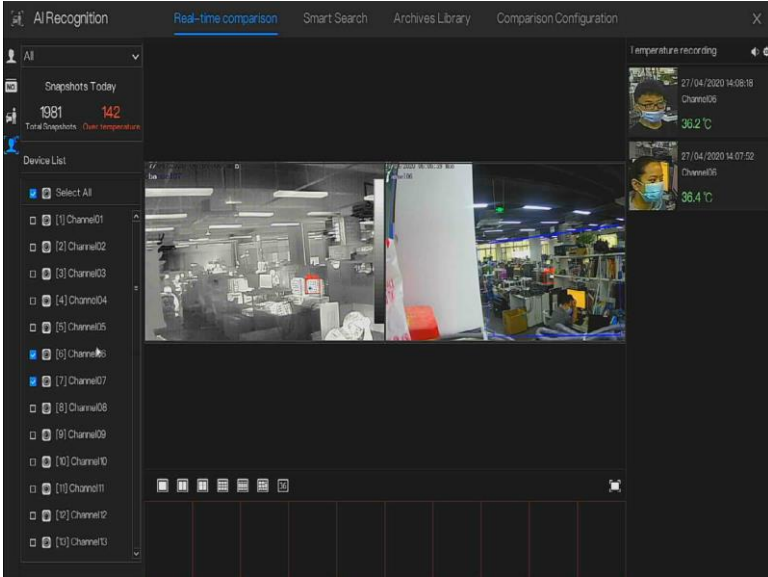
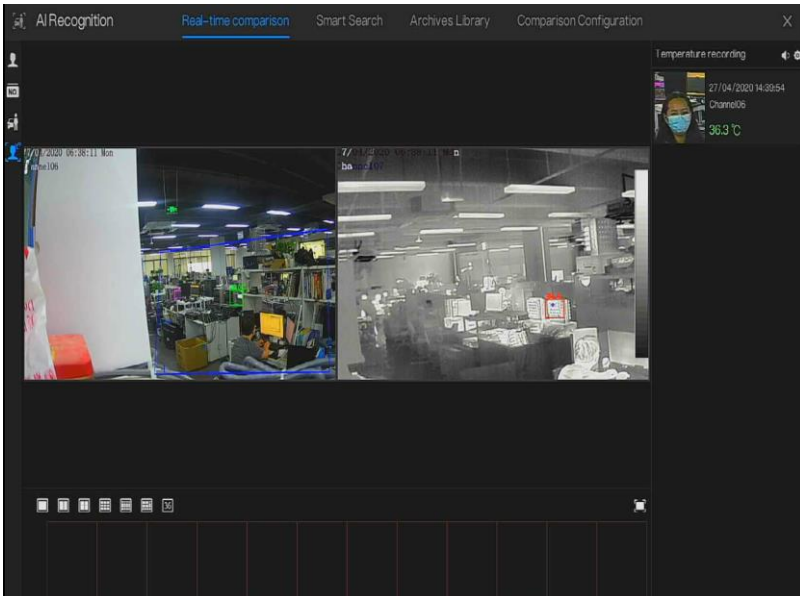

Figure 6-23 Full screen



If users enable the mask detection, the snapshot results will remind wear mask or no mask.

----End

6.4.2 Smart Search

At smart search interface, user can search the human face, vehicle license plate, full body, car, body temperature.

Up to 1000 pictures can be displayed. Click to see more details and export search result.

6.4.2.1 Human Face Search

Figure 6-24 Human face search

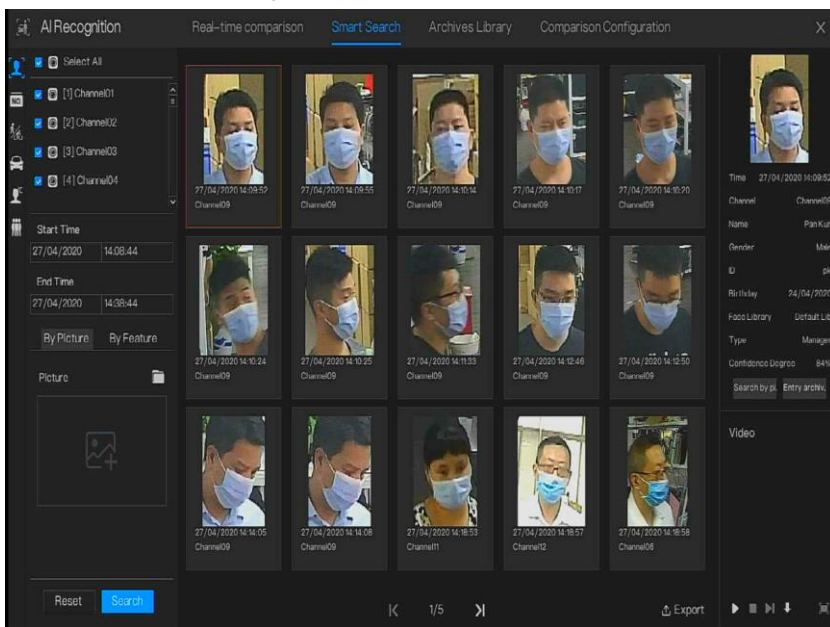

Step 1 Choose human face search at smart search interface.

Step 2 Tick the face recognition camera channels, set the start and end time.

Step 3 Choose the condition (by picture or by feature), the picture can be selected from the file folder.

Step 4 Click “Search” to search the snapshot of human face.

Step 5 The result will show at the middle of page, click the picture and the detail information show at the top right of page.

Step 6 The pictures can be added to library or used to search.

Step 7 Click play button of video to play the recording of snapshot, click “Backup” to back up the recording videos.

Figure 6-25 Back up

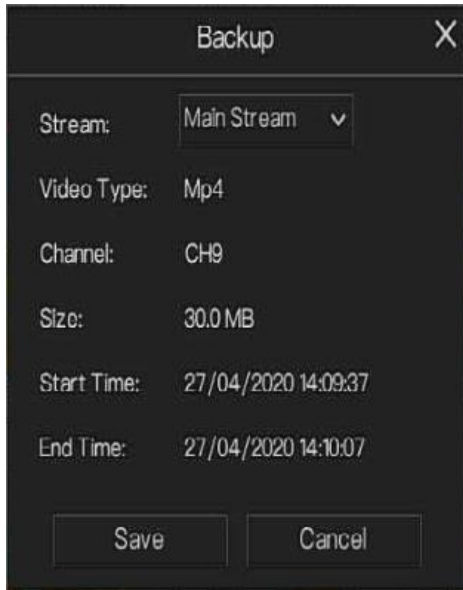

Step 8 Click “Export” to export the result, choose export type pictures or videos.

Figure 6-26 Export

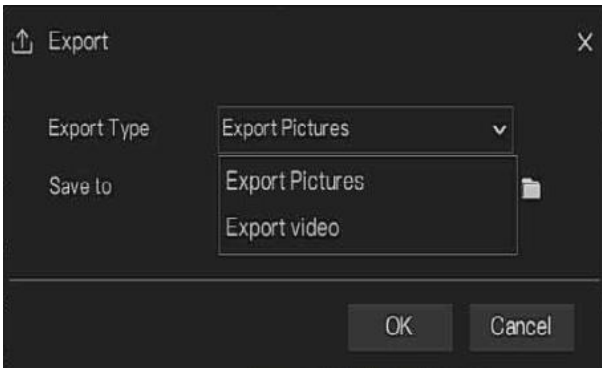

Play video of snapshot, it will play a 30-seconds video before and after the snapshot.

Quick Navigation

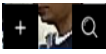
Snapshot in real time video, put the cursor on picture such as , you can add it to face library, or face search. The cursor on area 6 and the pictures is not update, move the mouse so that the pictures can be shown in time.

----End

6.4.2.2 Vehicle License Plate Search

Figure 6-27 Vehicle License Plate search

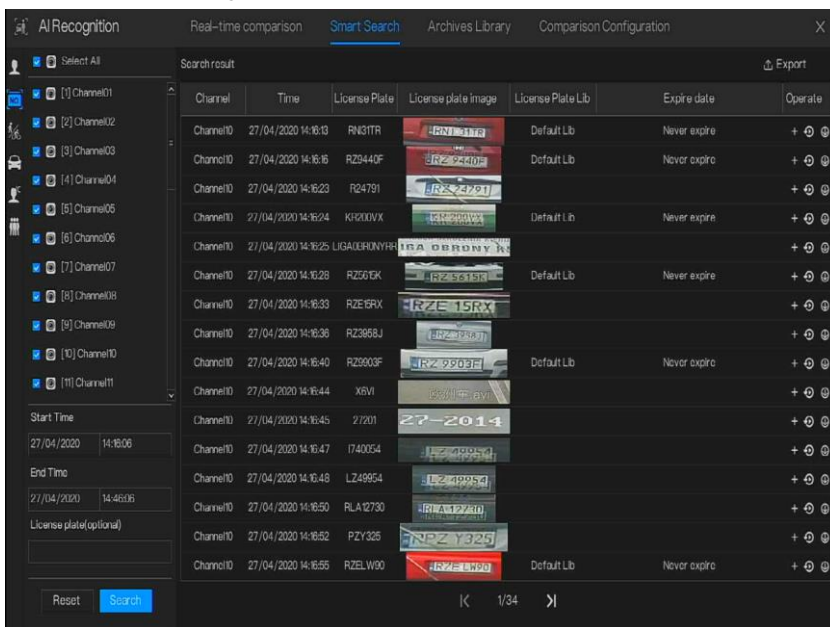

- Step 1 Choose vehicle License Plate at smart search interface.
- Step 2 Tick the vehicle license plate recognition camera channels, set the start time and end time.
- Step 3 Input the license plate optionally.
- Step 4 Click “Search” to search the snapshot of license plate.
- Step 5 The result will show at the page, click “+” add to library.
- Step 6 Click “Playback” to view the recording video, click “Backup” to back up the video.
- Step 7 Click “Export” to export the result.

----End

6.4.2.3 Full Body Search

Figure 6-28 Full body search

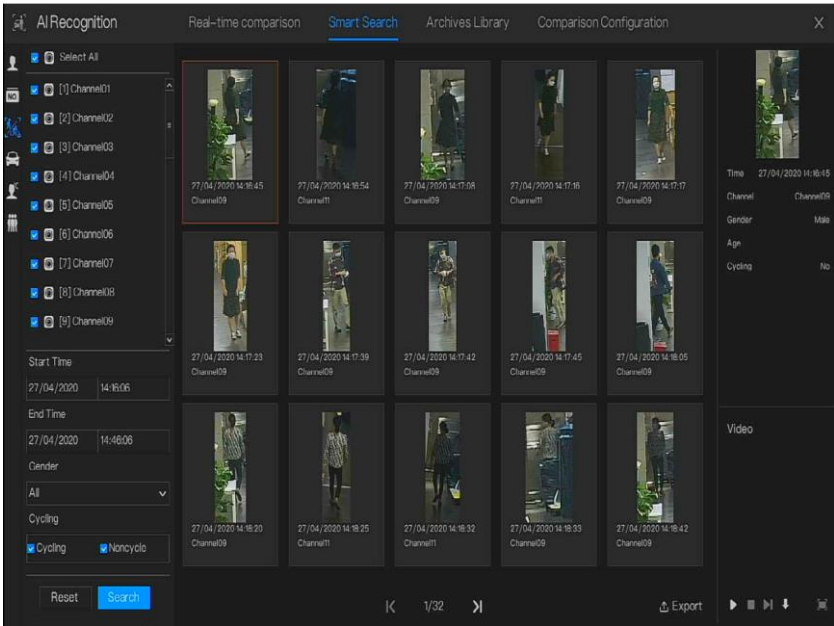

Step 1 Choose full body search at smart search interface.

Step 2 Tick the AI recognition camera channels, set the start time and end time.

Step 3 Set the gender, click cycling or no cycling .

Step 4 Click “Search” to search the snapshot of human face.

Step 5 The result will show at the middle of page, click the picture and the detail information show at the top right of page.

Step 6 Click play button of video to play the recording of snapshot, click “backup” to back up the video.

Step 7 Click “Export” to export the result.

----End

6.4.2.4 Vehicle Search

Figure 6-29 Vehicle search

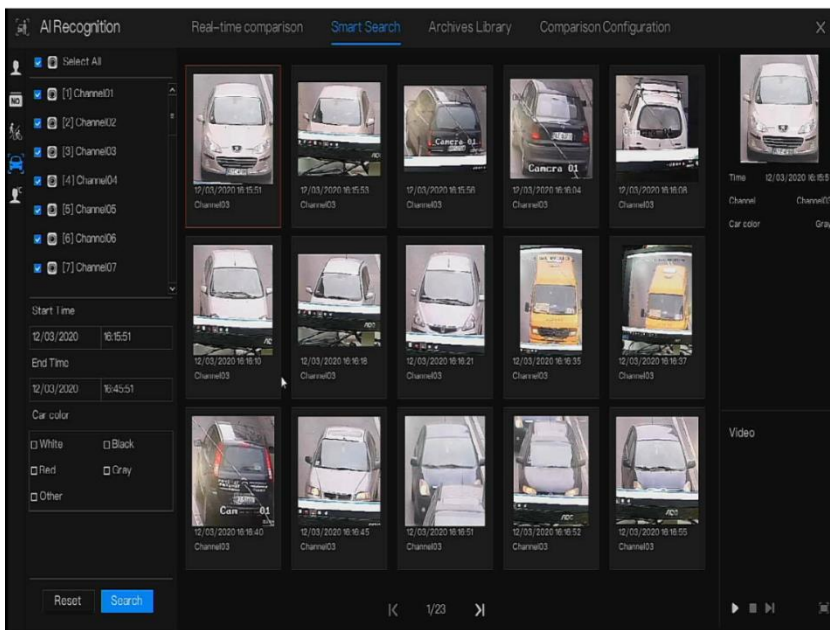

Step 1 Choose vehicle search at smart search interface.

Step 2 Tick the AI recognition camera channels, set the start time and end time.

Step 3 Tick the color.

Step 4 Click “Search” to search the snapshot of human face.

Step 5 The result will be showed at the middle of page, click the picture and the detail information show at the top right of page.

Step 6 Click play button of video to play the recording of snapshot, click “backup” to back up the video

Step 7 Click “Export” to export the result.

----End

6.4.2.5 Body Temperature Search

Figure 6-30 Body temperature search

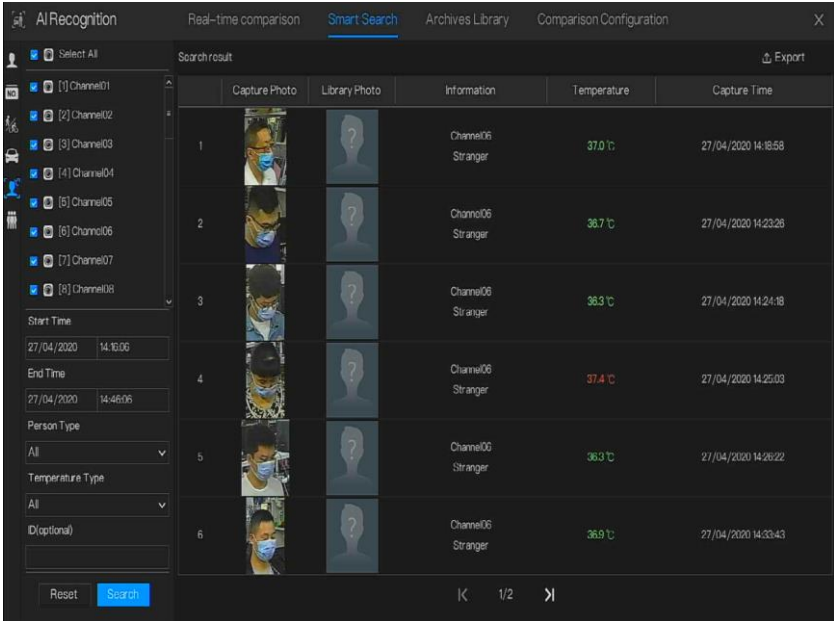

Step 1 Choose body temperature search at smart search interface.

Step 2 Tick the AI recognition camera channels, set the start time and end time.

Step 3 Choose the person type, temperature type, input ID optionally.

Step 4 Click “Search” to search the temperature.

Step 5 Click “Export” to export the result

----End

6.4.2.6 Personnel Count

Figure 6-31 Personnel count

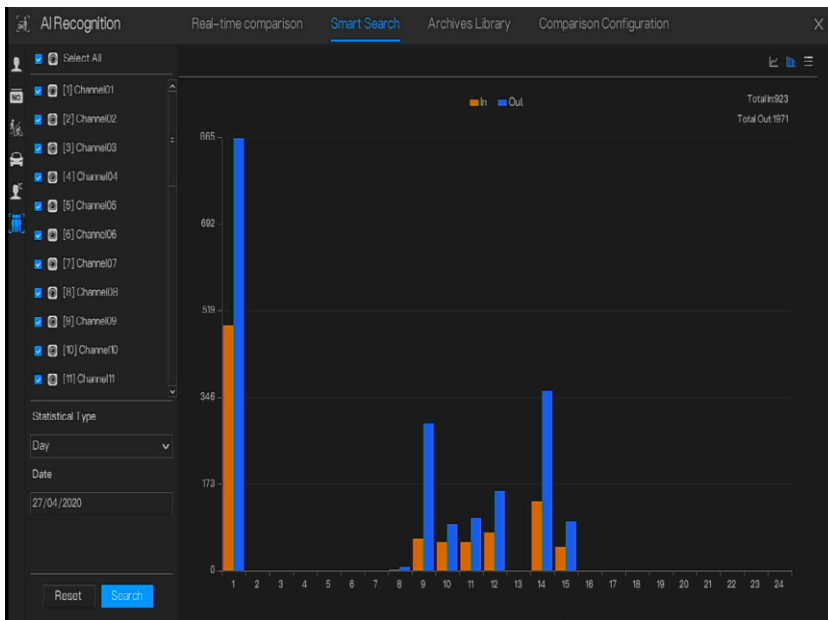

Step 1 Choose personnel count at smart search interface.

Step 2 Tick the AI recognition camera channels, set statistical type and date.

Step 3 Click “Search” to search the snapshot of human face.

Step 4 Click  to view the data in different data tables.

----End

6.4.3 Archives Library

At archives library, users can add or edit the face library , license plate library.

The license plate libraries can be imported to and exported from IP cameras.

6.4.3.1 Face Library

Figure 6-32 Face library

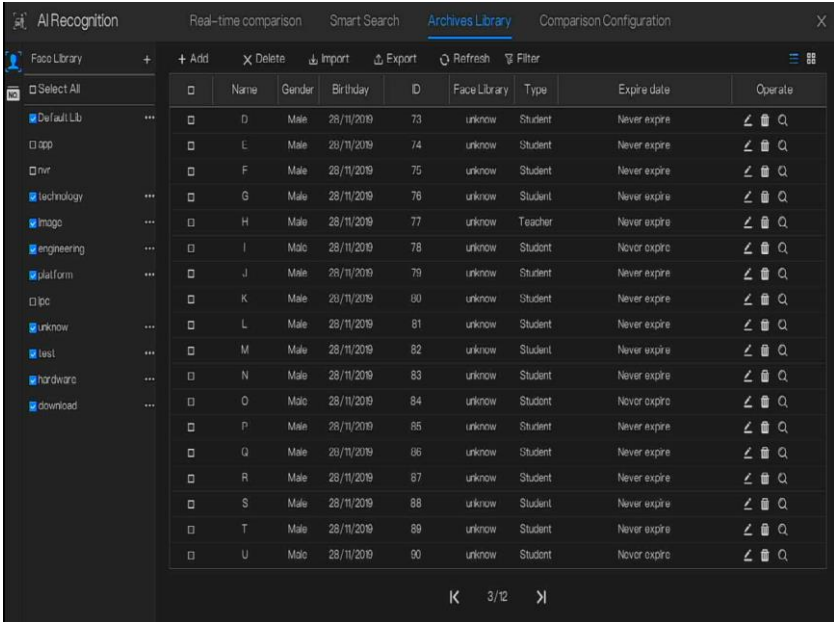

Click “+” to add a new face library.

Click “Add” to add person face.

Tick the person, click “Delete” to delete the person.

Click “Import” to add the person batch.

Click “Export” to export the all person in library.

Click “Filter” to filter the all persons in library, as shown in Figure 6-33.

Figure 6-33 Filter

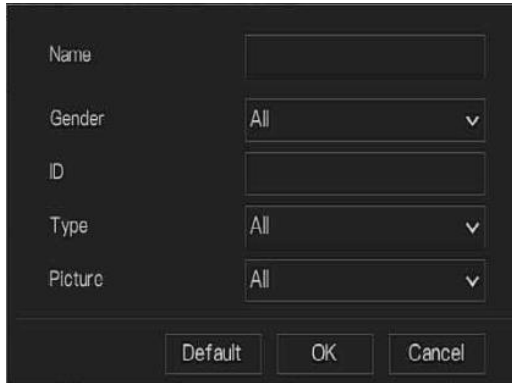
A dark-themed dialog box titled "Filter" with five input fields and three buttons. The fields are: "Name" (text input), "Gender" (dropdown menu with "All" selected), "ID" (text input), "Type" (dropdown menu with "All" selected), and "Picture" (dropdown menu with "All" selected). At the bottom are "Default", "OK", and "Cancel" buttons.

Name	<input type="text"/>
Gender	All ▼
ID	<input type="text"/>
Type	All ▼
Picture	All ▼
Default OK Cancel	

Click operate icon to edit or delete the chosen person.

----End

6.4.3.2 License Plate Library

At license plate library interface, users can add/delete/operate the library. It supports the white-list and black-list according the libraries to export and import the library to IP cameras.

Figure 6-34 License plate library

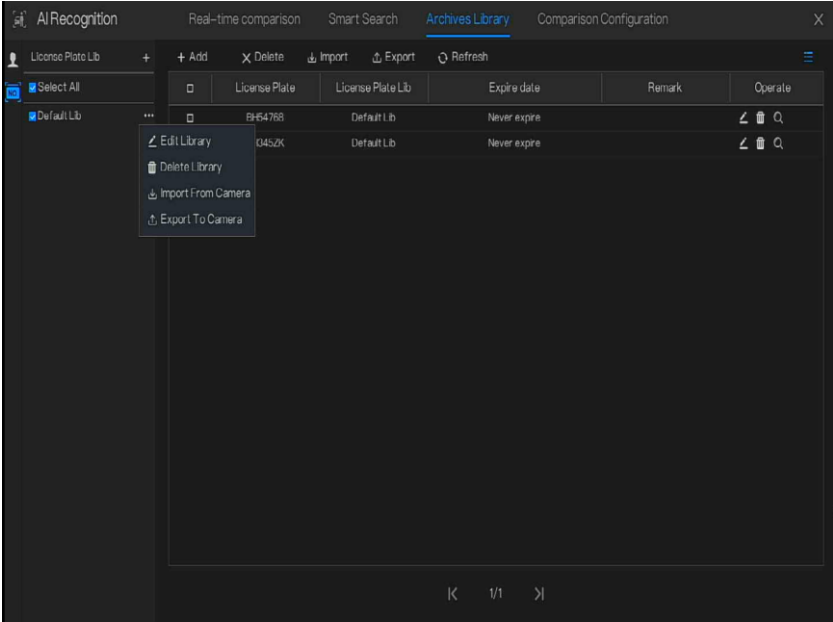

- Click “+” to add a new license plate library.
- Click “Add” to add a plate to library.
- Tick the plate, click “Delete” to delete the license plate.
- Click “Import” to add the license plate batch.
- Click “Export” to export the all-license plate library.
- Click operate icon to edit or delete the chosen license plate.
- Click “Import from Camera” to select license plate library to channel.

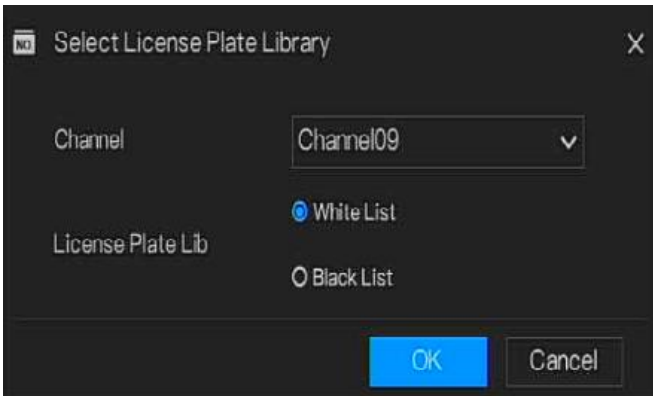

Click “Export to Camera” to add license plate number to camera.

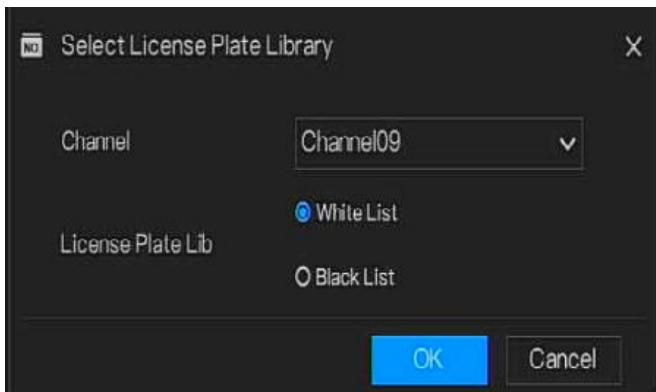

----End

6.4.4 Comparison Configuration

NOTE

The comparison function is only for AI cameras, please refer to actual cameras.

At comparison configuration interface, user can set the comparison of human face/ license plate/temperature/ mask detection configuration/ personnel count configuration.

6.4.4.1 Face Comparison

At face comparison interface, users can set different channels' strategy, such as similarity, display comparison result, face library, enable alarming, event action, arming time, as shown in Figure 6-35 .

Figure 6-35 Face comparison

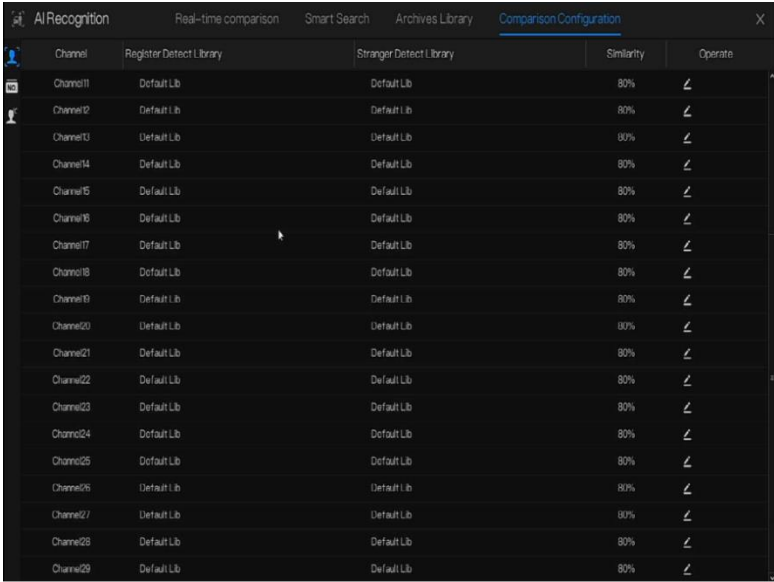

Channel	Register Detect Library	Stranger Detect Library	Similarity	Operate
Channel11	Default Lib	Default Lib	80%	↙
Channel12	Default Lib	Default Lib	80%	↙
Channel13	Default Lib	Default Lib	80%	↙
Channel14	Default Lib	Default Lib	80%	↙
Channel15	Default Lib	Default Lib	80%	↙
Channel16	Default Lib	Default Lib	80%	↙
Channel17	Default Lib	Default Lib	80%	↙
Channel18	Default Lib	Default Lib	80%	↙
Channel19	Default Lib	Default Lib	80%	↙
Channel20	Default Lib	Default Lib	80%	↙
Channel21	Default Lib	Default Lib	80%	↙
Channel22	Default Lib	Default Lib	80%	↙
Channel23	Default Lib	Default Lib	80%	↙
Channel24	Default Lib	Default Lib	80%	↙
Channel25	Default Lib	Default Lib	80%	↙
Channel26	Default Lib	Default Lib	80%	↙
Channel27	Default Lib	Default Lib	80%	↙
Channel28	Default Lib	Default Lib	80%	↙
Channel29	Default Lib	Default Lib	80%	↙

Figure 6-36 Strategy

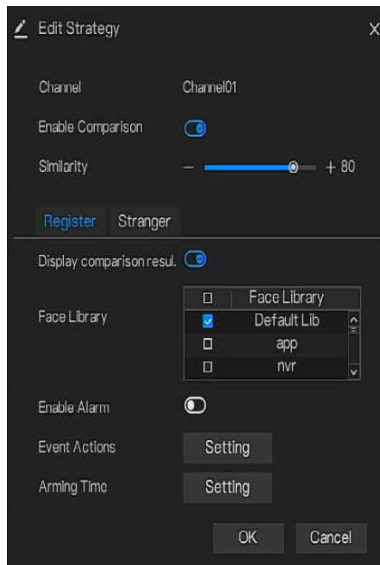

Edit Strategy

Channel: Channel01

Enable Comparison:

Similarity:

[Register](#) [Stranger](#)

Display comparison resul.

Face Library:

- Default Lib
- app
- nvr

Enable Alarm:

Event Actions: [Setting](#)

Arming Time: [Setting](#)

[OK](#) [Cancel](#)

----End

6.4.4.2 License Comparison

At license plate interface, users can set strategies of different channels of license plate recognition cameras, such as register and unregister, enable alarming, event action, arming time, as shown in Figure 6-37.

Figure 6-37 License comparison

Channel	Registered detection library	Unregistered detection library	Operate
Channel14	Default Lib	Default Lib	✓
Channel15	Default Lib	Default Lib	✓
Channel16	Default Lib	Default Lib	✓
Channel17	Default Lib	Default Lib	✓
Channel18	Default Lib	Default Lib	✓
Channel19	Default Lib	Default Lib	✓
Channel20	Default Lib	Default Lib	✓
Channel21	Default Lib	Default Lib	✓
Channel22	Default Lib	Default Lib	✓
Channel23	Default Lib	Default Lib	✓
Channel24	Default Lib	Default Lib	✓
Channel25	Default Lib	Default Lib	✓
Channel26	Default Lib	Default Lib	✓
Channel27	Default Lib	Default Lib	✓
Channel28	Default Lib	Default Lib	✓
Channel29	Default Lib	Default Lib	✓
Channel30	Default Lib	Default Lib	✓
Channel31	Default Lib	Default Lib	✓
Channel32	Default Lib	Default Lib	✓

Figure 6-38 Strategy

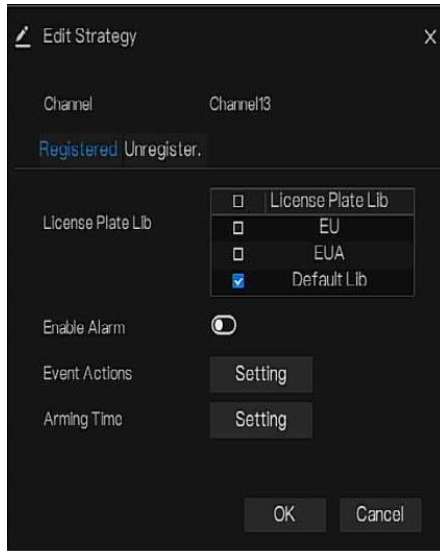

----End

6.4.4.3 Temperature Comparison



At comparison configuration interface, click  to enter the temperature configuration, as shown in Figure 6-39.

Figure 6-39 Temperature comparison



At temperature comparison interface, users can set low temperature threshold, high temperature threshold, and normal temperature.

Abnormal temperature measurement alarm, when it is turned on, the temperature below the low threshold and above the high temperature threshold will generate abnormal temperature alarm.

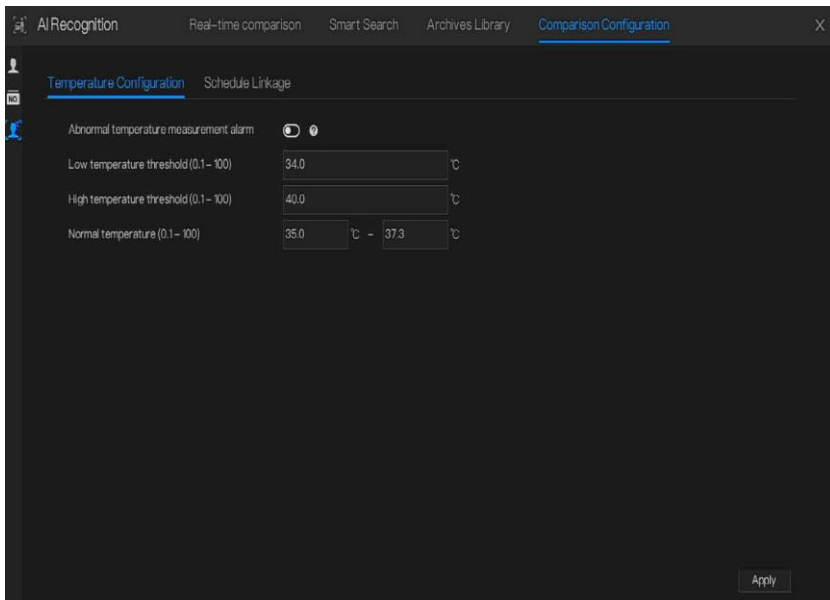
When it is turned off, body temperatures below the low threshold and above the high threshold are discarded.

Figure 6-40 Schedule linkage

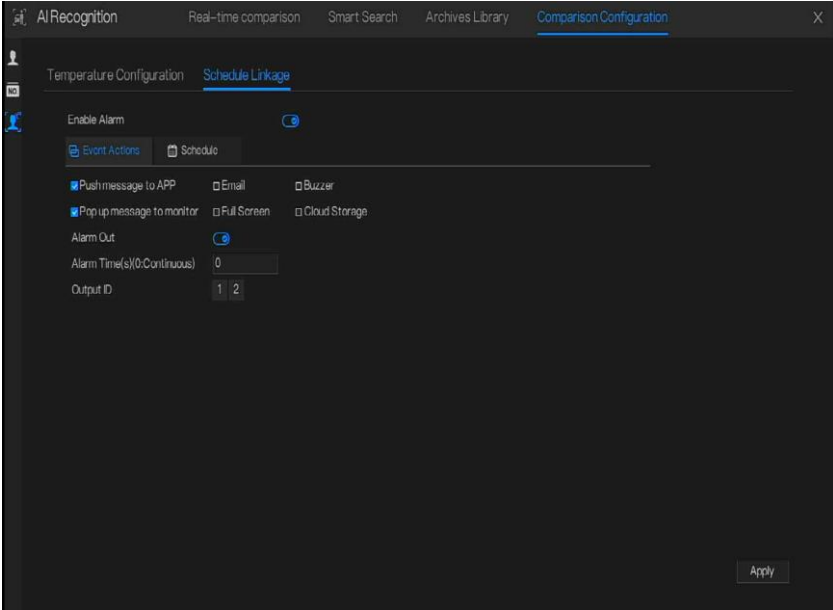

Enable alarm, set the schedule linkage, it will send alarm information if the temperature is higher than low threshold and lower the normal temperature, or higher than normal temperature and lower than high threshold.

----End

6.4.4.4 Mask Detection Configuration

Figure 6-41 Mask detection configuration

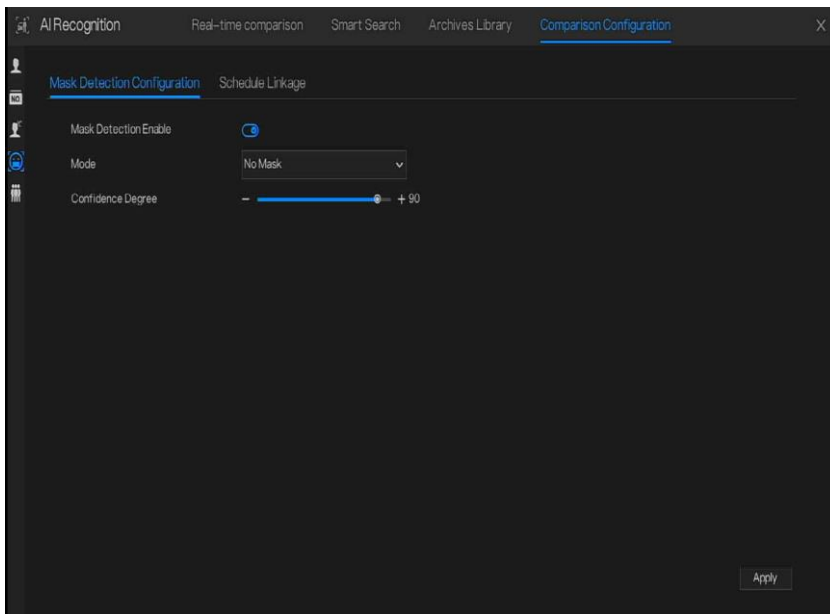

Enable mask detection, choose the mode (with or without a mask). Set the confidence degree, the default value is 90.

Figure 6-42 Schedule linkage

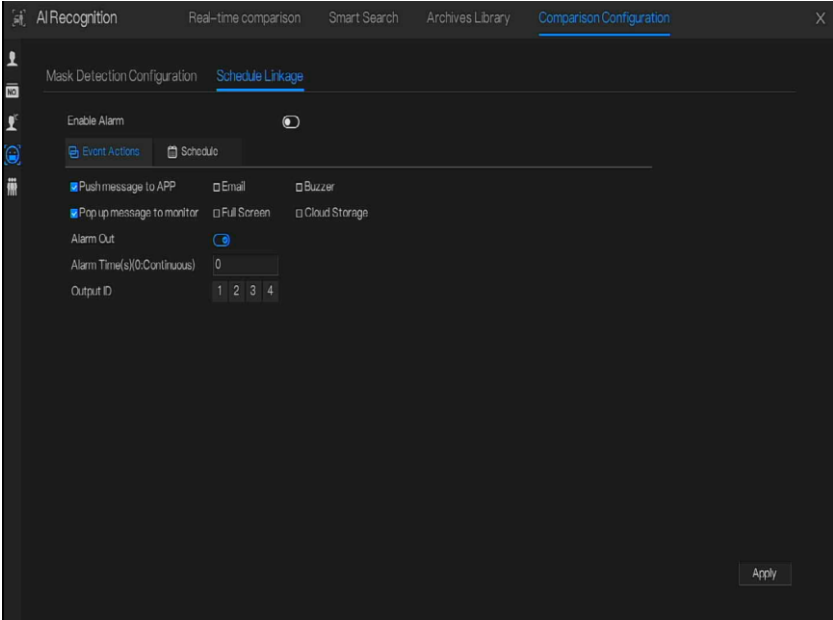

Enable the alarm, the real-time comparison can show if someone wears a mask or not.

Choose event actions, and set the schedule.

Click “Apply” to save the settings.

----End

6.4.4.5 Personnel Count Configuration

Figure 6-43 Personnel count configuration

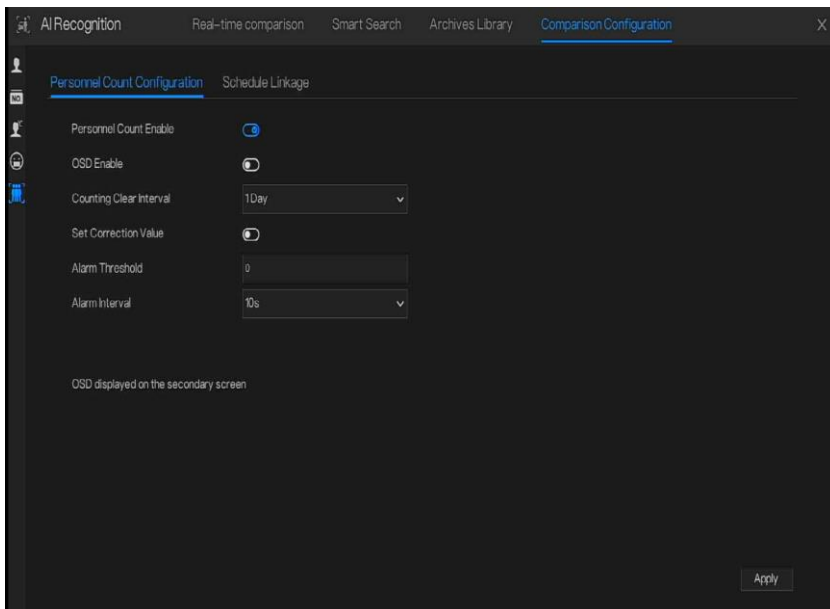

Enable personnel count to start the people counting.

Enable OSD to show OSD (OSD is displayed on the auxiliary screen, you need to start the auxiliary screen in "System> Auxiliary Screen" before displaying).

Select the counting clear interval (never, 10 minutes, half an hour, 1 hour, 12 hours, 1 day).

Set correction value, Configure the calibration value to start the manual calibration of the personnel count value.

Alarm threshold: when the people count reaches the threshold, an alarm is activated.

Alarm interval: 10s, 20s, 30s, 40s, 50s, 60s.

Click "Apply" to save the settings.

Figure 6-44 Schedule linkage

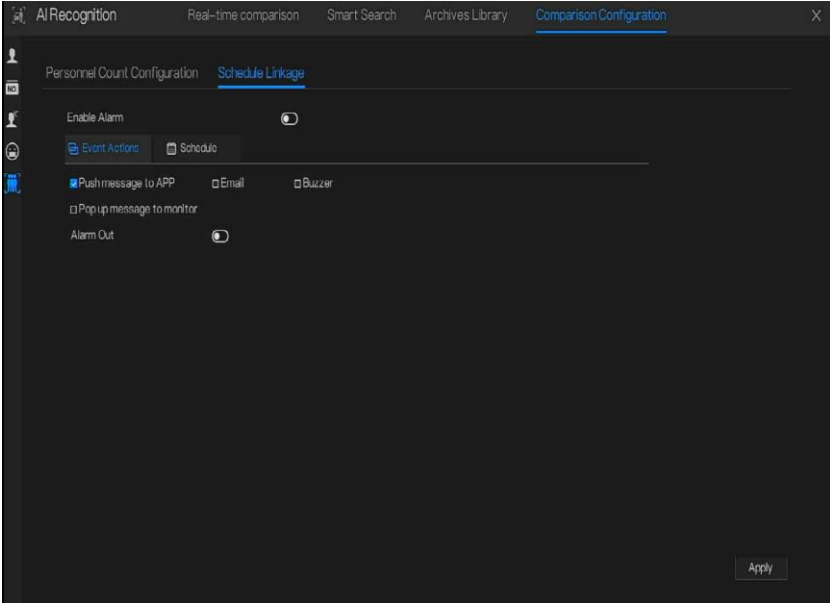

Set schedule linkage action to alarm.

----End

6.5 Attendance (Only for Some Models)

6.5.1 Attendance Data

Click to enter attendance data interface, as shown in Figure 6-45.

Figure 6-45 Attendance data

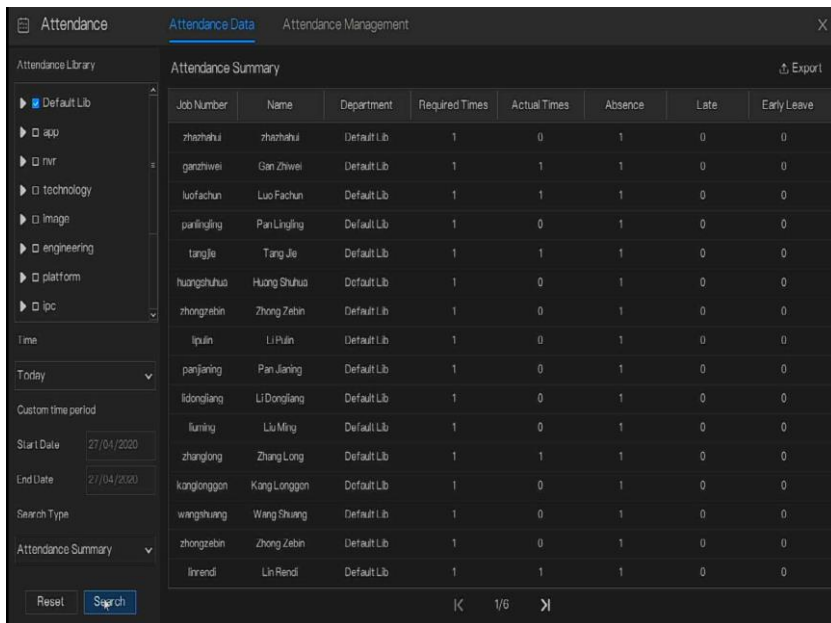

The screenshot displays the 'Attendance Data' interface. On the left is the 'Attendance Library' sidebar with categories like 'Default Lib', 'app', 'rnr', 'technology', 'image', 'engineering', 'platform', and 'ipc'. Below the library are filters for 'Time' (Today, Custom time period), 'Start Date' (27/04/2020), 'End Date' (27/04/2020), 'Search Type' (Attendance Summary), and 'Reset'/'Search' buttons. The main area shows an 'Attendance Summary' table with columns: Job Number, Name, Department, Required Times, Actual Times, Absence, Late, and Early Leave. The table contains 15 rows of data for various employees.

Job Number	Name	Department	Required Times	Actual Times	Absence	Late	Early Leave
zhazhuhui	zhazhuhui	Default Lib	1	0	1	0	0
ganzhwei	Gen Zhiwei	Default Lib	1	1	1	0	0
luofachun	Luo Fachun	Default Lib	1	1	1	0	0
panlingling	Pan Lingling	Default Lib	1	0	1	0	0
tangjie	Tang Jie	Default Lib	1	1	1	0	0
huangshuhua	Huang Shuhua	Default Lib	1	0	1	0	0
zhongzebin	Zhong Zebin	Default Lib	1	0	1	0	0
lipulin	Li Pulin	Default Lib	1	0	1	0	0
panjining	Pan Jining	Default Lib	1	0	1	0	0
lidongliang	Li Dongliang	Default Lib	1	0	1	0	0
liuming	Liu Ming	Default Lib	1	0	1	0	0
zhanglong	Zhang Long	Default Lib	1	1	1	0	0
kanglonggan	Kang Longgan	Default Lib	1	0	1	0	0
wangshuang	Wang Shuang	Default Lib	1	0	1	0	0
zhongzebin	Zhong Zebin	Default Lib	1	0	1	0	0
linrendi	Lin Rendi	Default Lib	1	1	1	0	0

Operation Steps

Step 1 Tick the attendance library.

Step 2 Choose time mode, such as today, this week, this month and custom time.

Step 3 Choose search type, such as attendance summary and attendance details.

Step 4 Click search, the result will show in interface.

Step 5 Click Export to export the query result.

----End

6.5.2 Attendance Management

In attendance management, users can set attendance rule, library and check point, as shown in Figure 6-46.

Figure 6-46 Attendance rule settings

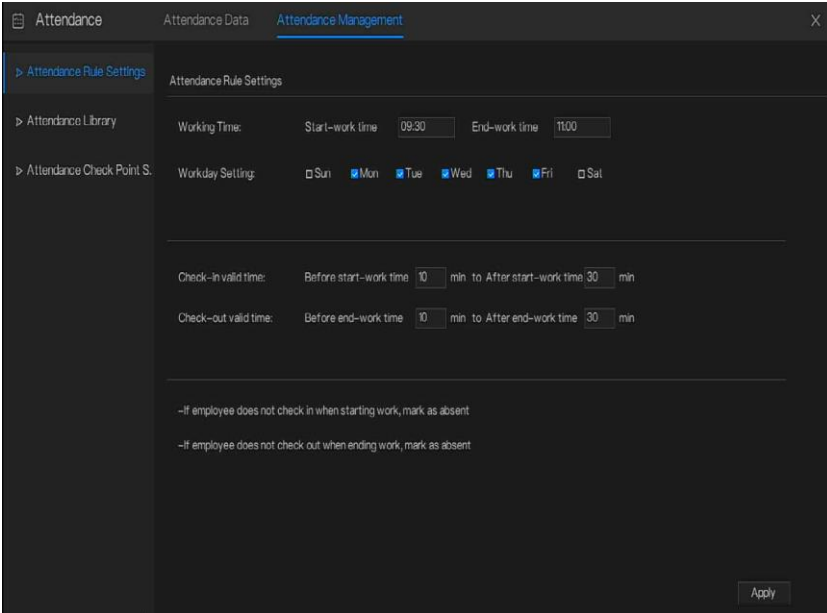

Operation Steps

- Step 1 Set start work time and end work time.
- Step 2 Tick the workday
- Step 3 Set valid time of check in and check out.
- Step 4 Click Save to save the setting.

Attendance library

- Step 1 Click **Attendance Library** to add library, the attendance library can call the face database directly.

Figure 6-47 Attendance library

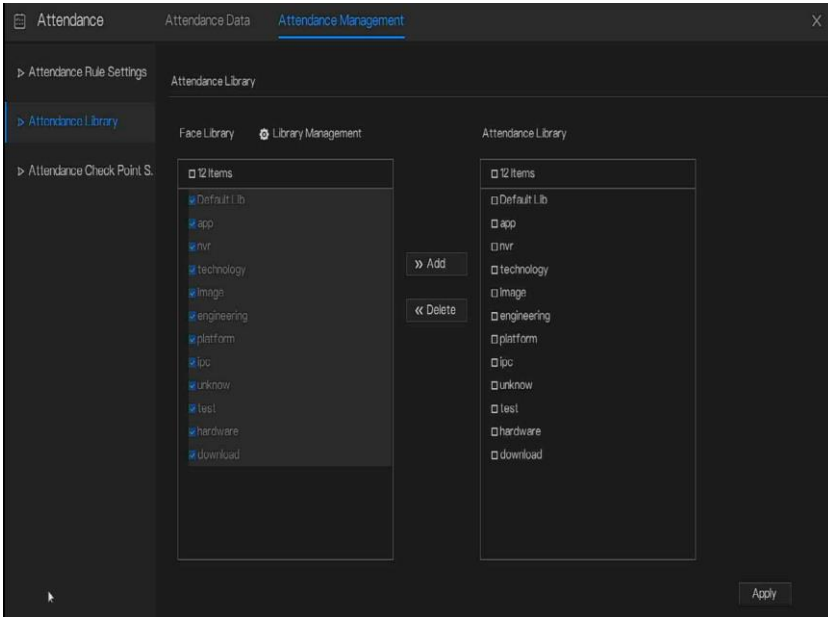

Step 2 Tick the library and click Add to add to attendance library. If you want to modify the library.

Step 3 click  Database management to enter the face database management to modify parameter.

Step 4 Click Save to save the setting.

Attendance check point settings:

Step 1 Click **Attendance check point** settings to set point, as shown in Figure 6-48.

Figure 6-48 Attendance check point setting

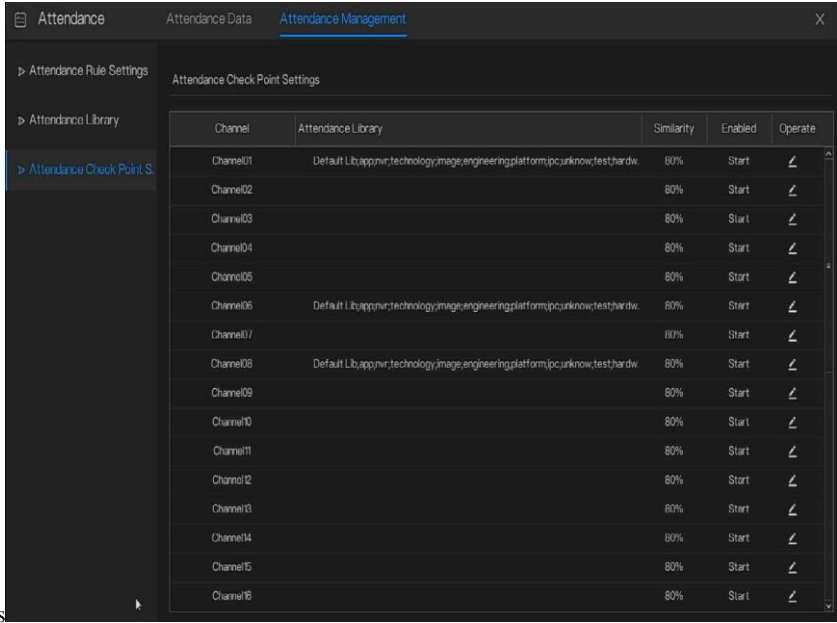

Step 2 Click  to edit check point setting, as shown in Figure 6-49

Figure 6-49 Check point



Step 3 Enable the function, set similarity and tick the library, all face detection cameras can be set the check points

Step 4 Click **OK** to save the setting.

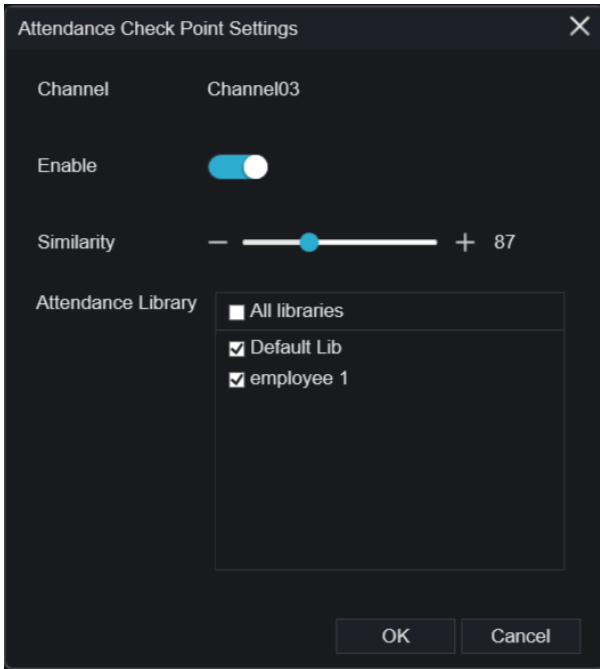
---End

6.6 Thermal Temperature (Only for Some Models)

NOTE

The thermal temperature function is only available for some devices. If the current device does not have the function, please ignore it.

6.6.1 Temperature Parameters

Temperature parameters include: temperature unit, ambient type, ambient temperature, cavity temperature, correctional coefficient and area temperature display mode.

Operation Procedure

Step 1 Choose Thermal >Temperature Parameters.

The **Temperature Parameters** page is displayed, as shown in Figure 6-50.

Figure 6-50 Temperature Parameters interface

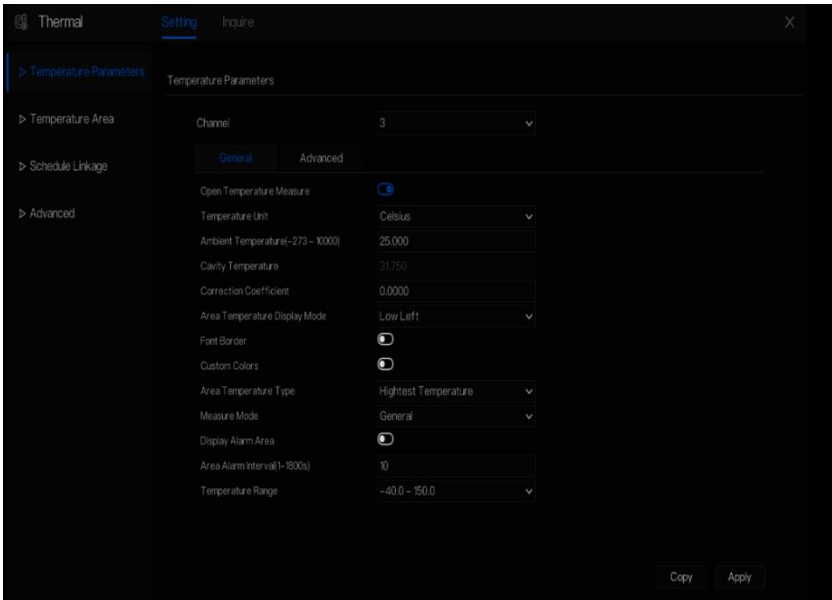

Step 2 Set the parameters according to Table 6-1.

Table 6-1 Temperature parameters

Parameter	Description	Setting
Open Temperature Measure	Enable temperature measure.	

Quick Navigation

Parameter	Description	Setting
Temperature Unit	Celsius and Fahrenheit temperature units are available.	[Setting method] Select a value from the drop-down list box. [Default value] Celsius
Ambient Temperature	The ambient temperature of camera. It is set when ambient is outside.	[Setting method] Enter a value manually.
Cavity Temperature	The cavity temperature of camera.	N/A
Correction Coefficient	Correction coefficient is refer to the deviation of measured object temperature and actual temperature. For example: 1. The measured object temperature is 30, and actual temperature is 37, so the correction coefficient should be 7 . 2. The measured object temperature is 37, and actual temperature is 30, so the correction coefficient should be -7 .	[Setting method] Enter a value manually. [Default value] 0.00
Area Temperature Display Mode	The display position of temperature information on the live-video image.	[Setting method] Select a value from the drop-down list box. [Default value] Low left
Font Border	The font will be bolded.	[Setting method] Enable or disable [Default value] disable
Custom Colors	Enable to custom the color, there are nine colors chosen.	[Setting method] Enable or disable [Default value] disable

Parameter	Description	Setting
Area Temperature Type	There are three types of area temperature.	[Setting method] Select a value from the drop-down list box. [Default value] Highest Temperature
Measure Mode	There are two types measure modes.	[Setting method] Select a value from the drop-down list box. [Default value] General
Display Alarm Area	N/A	[Setting method] Enable or disable [Default value] disable
Area Alarm Interval	N/A	[Setting method] Enter a value manually ranges from 1 to 1800. [Default value] 10

Figure 6-51 Advanced parameter

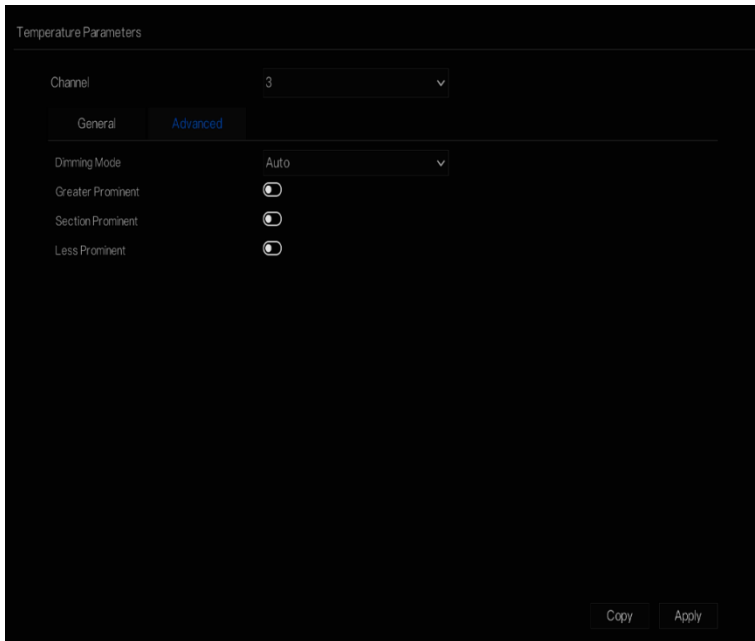

Table 6-2 Advanced parameters

Parameter	Description	Setting
Dimming Mode	There are auto and manual modes. It will show on temperature item.	[Setting method] Select a value from the drop-down list box. [Default value] Auto
Greater Prominent	Enable that, the image will show the setting color if the temperature is higher than set value.	[Setting method] Enter a value manually. Choose one color to show.
Section Prominent	Enable that, the image will show the setting color if the temperature is between minimum and maximum temperature.	[Setting method] Enter a value manually. Choose one color to show.

Parameter	Description	Setting
Less Prominent	Enable that, the image will show the setting color if the temperature is lower than set value.	[Setting method] Enter a value manually. Choose one color to show.

Step 3 Click **Copy** to copy the same settings to others thermal cameras.

Step 4 Click **Apply**.

Step 5 The message "Apply success" is displayed, the system saves the settings.

----End

6.6.2 Temperature Area

Operation Procedure

Step 1 Choose Thermal >Temperature Area.

The **Temperature Area** page is displayed, as shown in Figure 6-52

Figure 6-52 Temperature area and alarm configuration

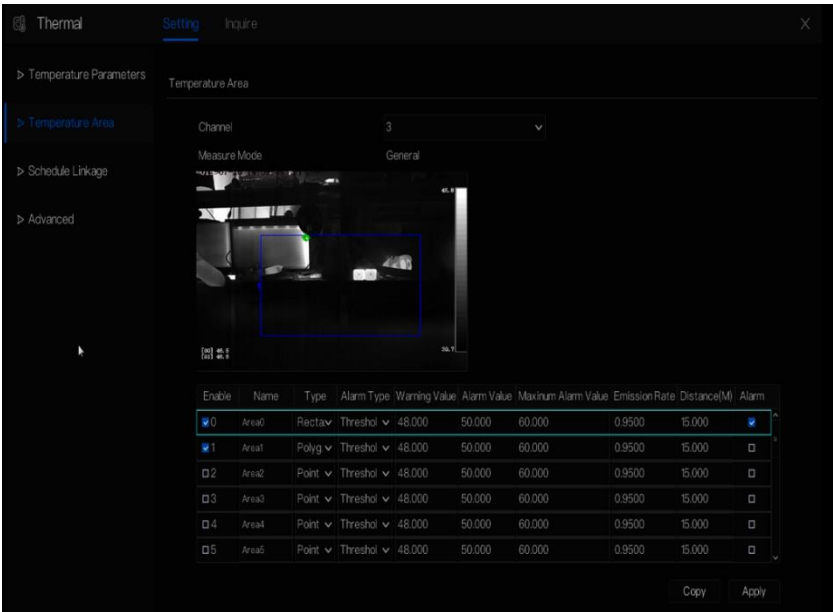

Step 2 Set the parameters according to Table 6-3

Table 6-3 Temperature area and alarm configuration

Parameter	Description	Setting
Channel	N/A	[Setting method] Select a value from the drop-down list box. [Default value] 1
Measure Mode	Set at temperature parameter interface.	N/A
PTZ Area(only use for PTZ cameras)	Choose or set the preset, adjust the camera with PTZ keyboard. The all presets can set 20 areas to alarm	Set the preset manually, or select an existing preset in the drop-down list.
Enable	Tick to enable alarm areas.	N/A
ID	It ranges from 0 to 19.	N/A
Name	Area name of temperature area.	[Setting method] Enter a value manually.
Type	Type of temperature area. ID 0 is default rectangle area, which is full screen. There are 20 areas can be set, these are from 0 to 19 area.	[Setting method] Select a value from the drop-down list box. [Default value] Rectangle/Point
Alarm Type	Threshold alarm and Temperature difference alarm are available for alarm type.	[Setting method] Select a value from the drop-down list box. [Default value] Threshold alarm
Warning Value	Camera will warn when the surveillance object temperature reaches the warning value.	[Setting method] Enter a value manually. [Default value] 48.00
Alarm Value	Camera will alarm when the surveillance object temperature reaches the alarm value.	[Setting method] Enter a value manually. [Default value] 50.00
Maximum Alarm Value	The maximum value of the alarm range, if the alarm value is exceeded, no alarm will be generated.	[Setting method] Enter a value manually. [Default value] 60.00

Parameter	Description	Setting
Emission Rate	The emission rate is the capability of an object to emit or absorb energy. The emission rate should be set only when the target is special material.	[Setting method] Enter a value manually. [Default value] 0.95
Distance(M)	The distance between camera and target.	[Setting method] Enter a value manually. [Default value] 15  NOTE Enter actual distance when the distance between camera and target is less than 15 m. Enter 15 when the distance between camera and target is great than or equal to 15 m.
Alarm	Open or close the alarm output and linkage of area.	[Setting method] Tick the alarm areas

Step 3 Set temperature area.

1. Tick an area ID.
2. Select type from drop-list.
3. Press and hold the left mouse button, and drag in the video area to draw a temperature area. Right-click to finish the area selection.
4. Click **Apply**, the message “Apply success” is displayed, the temperature area is set successfully.

Delete a temperature area:

1. Select an area ID.
2. Click the temperature area and right-click.
3. Unselected the area ID.
4. Click **Apply**, the message “Apply success” is displayed, the temperature area is deleted successfully.

Step 4 Click **Apply**.

Step 5 The message "Apply success" is displayed, the system saves the settings.

----End

6.6.3 Schedule Linkage

Operation Procedure

Step 1 Choose Thermal > Schedule Linkage

The **Schedule Linkage** page is displayed, as shown in Figure 6-53.

Figure 6-53 Schedule Linkage

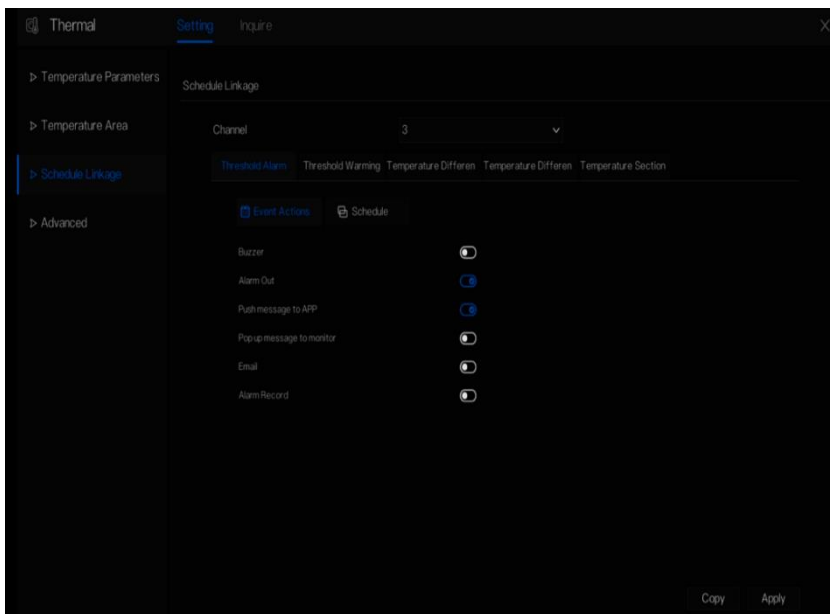

Step 2 Tick the output channel.

Step 3 Enable “Alarm Record”, “E-mail” button.

Step 4 Set schedule linkage.

Figure 6-54 Schedule

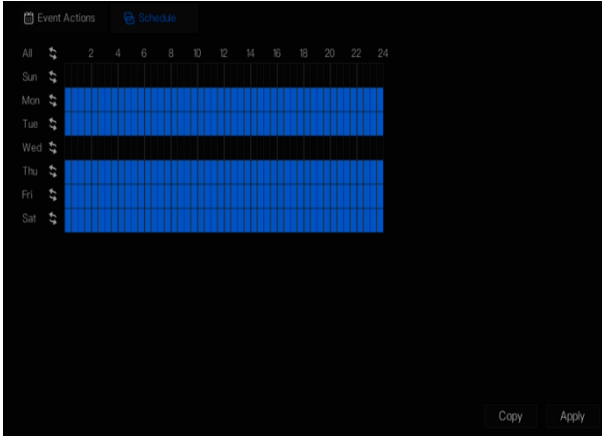

Method 1: Click left mouse button to select any time point within 0:00-24:00 from Monday to Sunday as shown in Figure 6-53.

Method 2: Hold down the left mouse button, drag and release mouse to select the alarm time within 0:00-24:00 from Sunday to Saturday.

 **NOTE**

When you select time by dragging the cursor, the cursor cannot be moved out of the time area.

Otherwise, no time can be selected.

Method 3: Click  in the alarm time page to select the whole day or whole week.

Deleting alarm time: Click  again or inverse selection to delete the selected alarm time.

Step 5 Click **Apply**.

Step 6 The message "Apply success" is displayed, the system saves the settings.

----End

6.6.4 Advanced

Operation Procedure

Step 1 Choose **Thermal** > **Advanced** to enter the advance interface, as shown in Figure 6-55.

Figure 6-55 Advanced

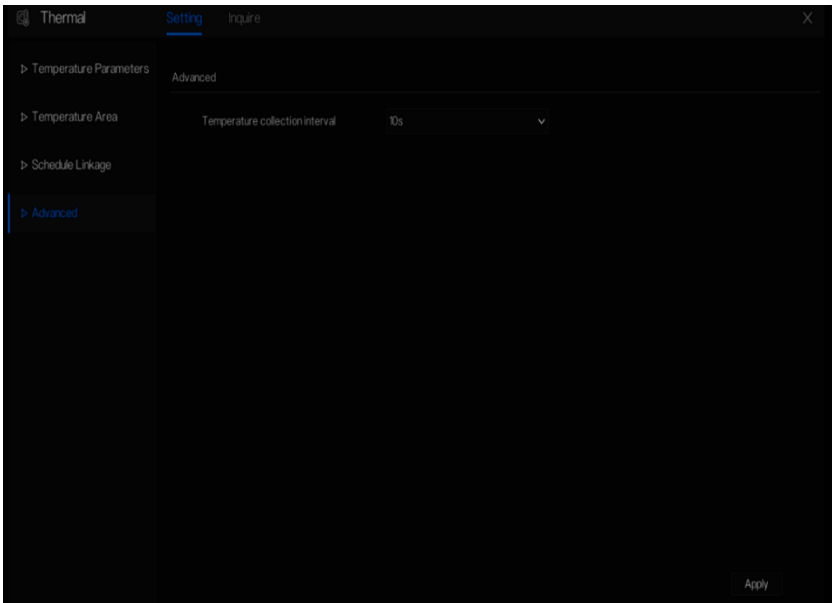

Step 2 Select the temperature collection interval from the drop-list.

Step 3 Click **Apply**.

Step 4 The message "Apply success" is displayed, the system saves the settings.

----**End**

6.6.5 Inquire

Operation Procedure

Step 1 Choose **Thermal** > **Inquire** to enter the inquire interface, as shown in Figure 6-56.

Figure 6-56 Inquire

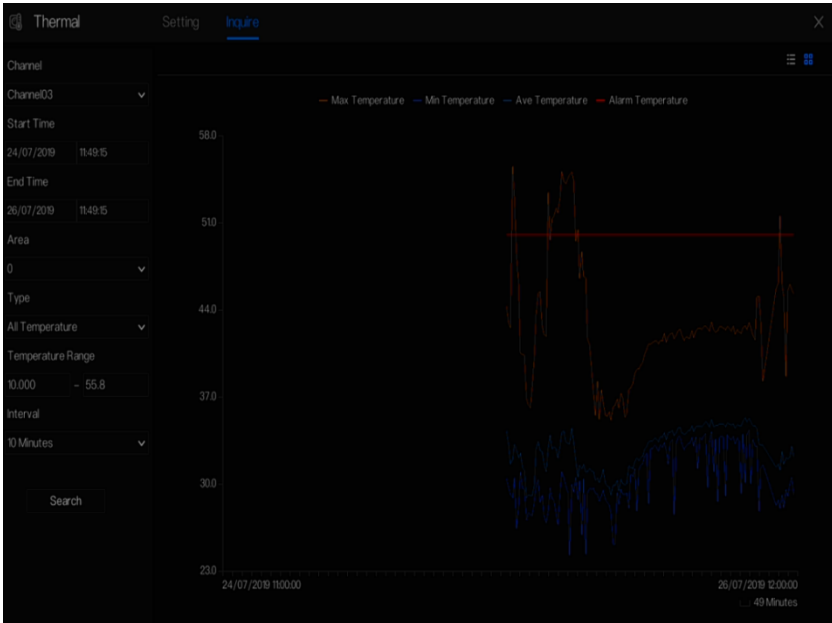

Step 2 Choose a channel is thermal camera.

Step 3 Set the start and end time.

Step 4 Choose the area, which is set at the temperature area interface. The default area is 0(full screen).

Step 5 Choose the type of temperature, set the temperature range.

Step 6 Choose the interval of showing, click **Search** to show the result, there are two modes to show result, list or picture.

----**End**

6.7 Channel Information

Click the  will show as Figure 6-57, tick the Channel or Encode, the information will show in live video screen.

Figure 6-57 Channel information



----End

6.8 Main Menu

Right-click on the UI screen, the main menu as shown in Figure 6-58. The main menu includes **Channel**, **Record**, **Network**, **Alarm** and **System**.

Figure 6-58 NVR main menu

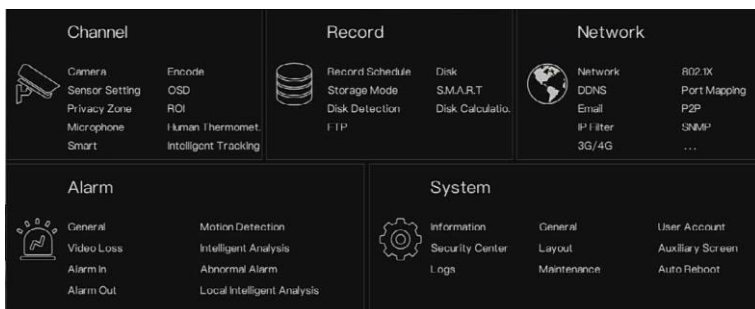

----End

7 UI System Setting

NOTE

Different devices may have different functions, please refer to actual products.

7.1 Channel Management

IP cameras can directly be connected to input channels of the NVR by plugging in POE port.

When IP cameras are insufficient, the NVR can automatically search for and add IP cameras or manually add cameras in the same Local Area Network (LAN).

Channel management includes **Add** or **Delete Camera**, **Encode**, **Sensor Setting**, **OSD**, **Privacy Zone**, **ROI**, **Microphone**, **Human Thermometer**, **Smart**, and **Intelligent Tracking**.

7.1.1 Camera

Operation Description

Click **Channel** in the main menu to access the camera management screen, as shown in Figure 7-1 There are four modes for adding cameras, manually add, batch add, search to add, POE add, and automatic add.

Figure 7-1 Channel management screen

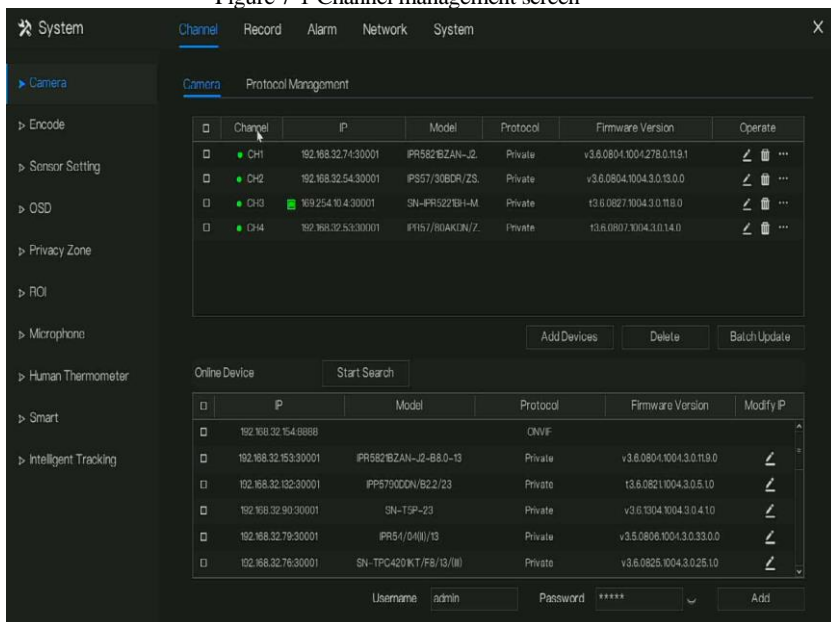

The screenshot shows the 'Channel Management' interface. On the left is a sidebar with categories like Camera, Encode, Sensor Setting, OSD, Privacy Zone, ROI, Microphone, Human Thermometer, Smart, and Intelligent Tracking. The main content area is titled 'Camera' and contains a table of channels. Below the table are 'Add Devices', 'Delete', and 'Batch Update' buttons. At the bottom, there is a search bar for 'Online Device' and a login form with 'Username' (admin) and 'Password' (*****).

Channel	IP	Model	Protocol	Firmware Version	Operate
CH1	192.168.32.74.30001	IPR582BZAN-J2	Private	v3.6.0804.1004.1278.0.119.1	[Edit] [Delete] [More]
CH2	192.168.32.54.30001	IP57/30BOR/ZS	Private	v3.6.0804.1004.3.0.13.0.0	[Edit] [Delete] [More]
CH3	169.254.10.4.30001	SN-IPR522EH-I-M	Private	v3.6.0827.1004.3.0.118.0	[Edit] [Delete] [More]
CH4	192.168.32.53.30001	IP115/780AKIN/Z	Private	v3.6.0807.1004.3.0.14.0	[Edit] [Delete] [More]

IP	Model	Protocol	Firmware Version	Modify IP
192.168.32.154.8888		ONVIF		[Edit]
192.168.32.153.30001	IPR582BZAN-J2-B8.0-13	Private	v3.6.0804.1004.3.0.119.0	[Edit]
192.168.32.132.30001	IPP57900CN/52.2/23	Private	v3.6.0821.1004.3.0.5.1.0	[Edit]
192.168.32.90.30001	SN-TSP-23	Private	v3.6.1004.1004.3.0.4.1.0	[Edit]
192.168.32.78.30001	IPR54/D(II)/13	Private	v3.5.0806.1004.3.0.33.0.0	[Edit]
192.168.32.76.30001	SN-TPC420KT/FB/13/III	Private	v3.6.0825.1004.3.0.25.1.0	[Edit]

Username: admin Password: ***** Add



: Modify device parameters, remote channel is based on cameras (human body temperature has two remote channels, fisheye cameras have four remote channels) as shown in Figure 7-2.

Figure 7-2 Modify device parameter

Modify device parameters

Channel Name: Channel10

IP Address: 192 . 168 . 1 . 83

Protocol: Private

Port: 30001

Username: admin

Password: *****

Remote Channel: CH-1

OK Cancel

----End

7.1.1.1 Add Camera Automatically

The NVR can add automatically cameras to the camera list.

Operation Methods



Method 1: Click **Start Search** button, the cameras in the same network as your recorder will show in list, the search will be lasting for 20 seconds. Input username and password (the default value both are admin) click **Add Devices**, the cameras in the list would be added to channels directly.

Method 2: Select the cameras you want to add, and click **Add**, the selected cameras would be added to the camera list.

Tick the online non-onvif channels at list and click **Batch Update** to access the directory of software; it would to update the channels at once.

NOTE

UI System Setting

On the camera management screen, check the status of channels in the camera list. If the status of a channel is , this camera is online. If the status of a channel is , this camera is offline.

The added cameras should be the same network as NVR.

----End

7.1.1.2 Add Camera Manually

Operation Steps

Step 1 Click  to add devices as shown in Figure 7-3.

Figure 7-3 Add camera screen



Channel	IP	Protocol
CH1	169.254.10.2:30001	Private
CH2	192.168.99.146:30001	Private
CH3	192.168.99.145:30001	Private

Channel: 7

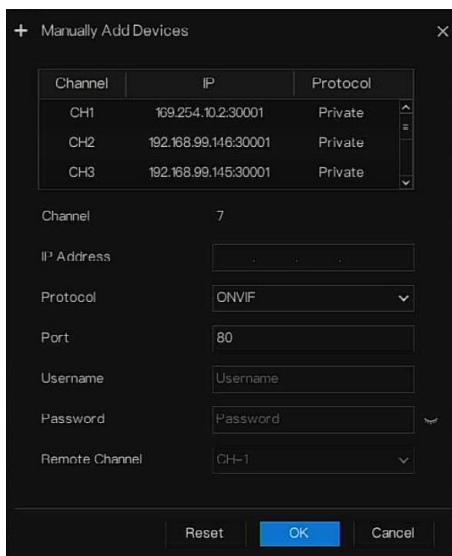
IP Address:

Protocol: ONVIF

Port: 80

Username:

Password:

Remote Channel: CH+1

Reset OK Cancel

Step 2 Input IP address, port, user name and password of this camera. Double click the online camera IP to copy its configuration. Quick change of other channel's parameters can be done.

Step 3 Select a protocol from the drop-down list(ONVIF, Private, custom protocols). Remote channel is only used for multi channels cameras, such as human temperature cameras, fisheye cameras, and so on.

Step 4 Click , the camera is added successfully.

 **NOTE**

If all channels of the NVR are connected by cameras, please delete the cameras that you don't need , so that you can add more cameras.

If an IP camera is added manually, input the correct username and password of the camera below the online device list. The camera will be added successfully. If not the camera would be shown on list at offline.

The protocol can be chosen the custom protocols these are set at protocol interface.

The user can click the added channel to copy the information to save the time, you can just need to modify difference information, such as the remote channel.

----End

7.1.1.3 Add Camera by RSTP

If the user wants to add the different protocol cameras to NVR, you can set the protocol management, and add cameras one by one, as shown in Figure 7-4.

Figure 7-4 Protocol management

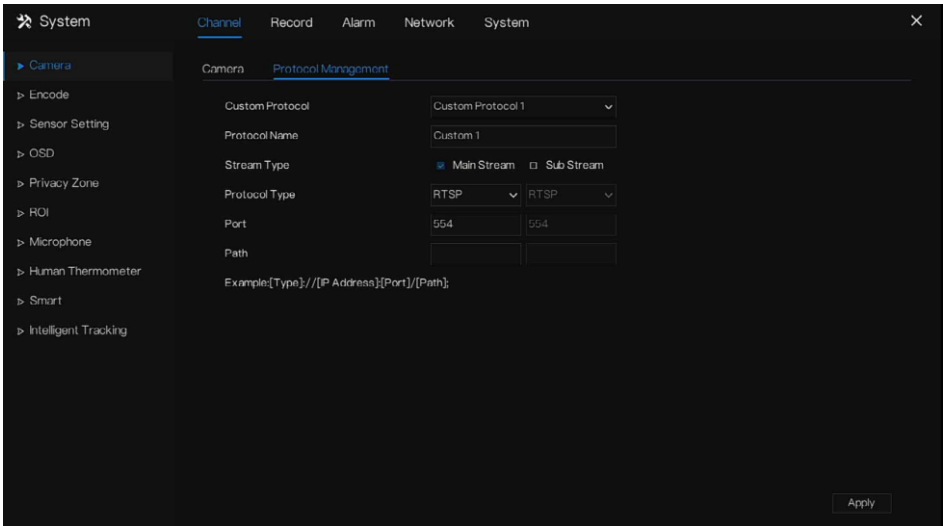

Step 1 Click **Channel > Camera > Protocol Management**.

Step 2 Choose the custom protocol from the drop-down list, there are 16 kinds of protocols can be set.

UI System Setting

Step 3 Input the protocol name.

Step 4 Tick main stream and sub stream. The main stream shows image on full screen live video.

The sub stream shows image on split screen. If you just tick main stream and the channel will not show image on split screen.

Step 5 Choose the type of protocol, the default value is RTSP.

Step 6 Input the port of the IP camera.

Step 7 Input the path (it may vary with different camera models).

Step 8 Click Apply to save the settings.



NOTE

Choose the protocol from the drop-down list, the protocol is set at protocol management interface.

The cameras should be confirmed to the protocols.

----End

7.1.1.4 Delete Camera

Operation Steps

Step 1 Select a camera to delete in the camera list and click , the delete confirmation message screen is displaying, as shown in Figure 7-5.

Figure 7-5 Delete confirmation message



Step 2 Click , the camera will be deleted successfully.

7.1.1.5 Operate Camera

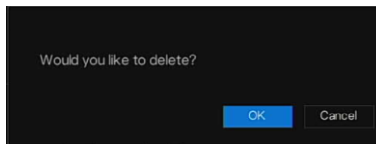
At camera list, click  to operate camera as shown in Figure 7-6, users can update, reboot and reset the camera immediately.

Figure 7-6 More operation



- Step 1 Click **Update**, pop-up window to select software, as shown in Figure 7-7.
- Step 2 Set the directory click **OK** to update camera.

Figure 7-7 Select directory of software

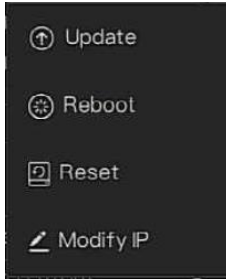
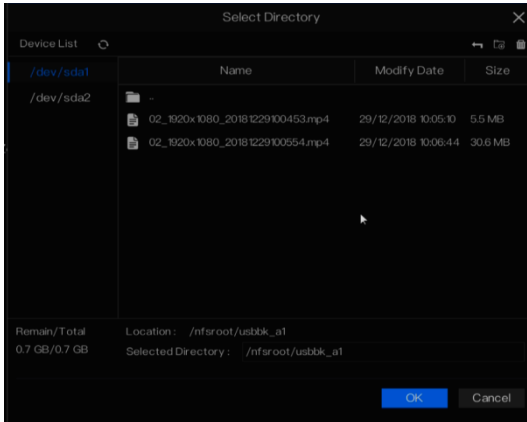

- Step 3 Click **Reboot**, message “Are you sure to reboot?” would show, click **OK** to reboot the camera.
- Step 4 Click **Reset**, message “Are you sure to reset?” would show, users can enable the retain IP address function. Click **OK** to reboot the camera.
- Step 5 Tick the cameras with non-onvif protocol and cameras are online, click **Update** to update all cameras at once.
- Step 6 IP address of the online camera can be modified, click **Modify IP** to modify as shown in following figure, input the new IP address and subnet mask.

NOTE

Update need upload the firmware by flash driver.

----End

7.1.2 Encode Parameter

The system allows setting the stream information, encoding type, resolution, frame rate, bitrate control, bitrate and quality for cameras in a channel in **Encode Parameter** screen.

Operation Description

Click **Encode** in the main menu or **Menu** of the channel management screen and choose **Encode** to access the **Encode** screen, as shown in Figure 7-8.

Figure 7-8 Encode screen

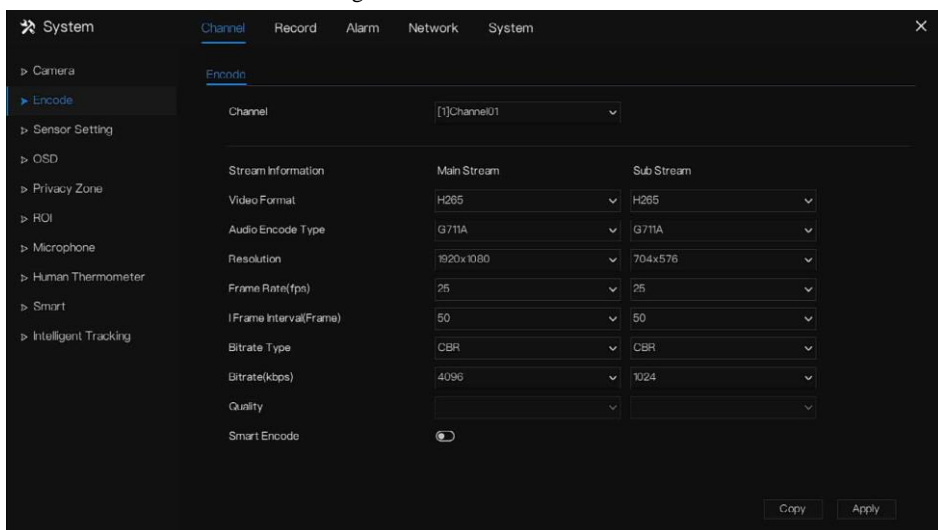

Operation Steps

Step 1 Select a channel from the drop-down list of channel.

Step 2 Set video format, audio encode type, resolution, frame rate, bitrate type, bitrate size and quality from the drop-down lists.

Step 3 Click **Copy** and select channels or tick **all**, then click **OK** to apply the parameter settings to cameras in selected channels, click **Apply** to save encode parameter settings.

----End

7.1.3 Sensor Setting

Sensor setting refers to basic attributes of pictures, it includes the brightness, sharpness, contrast and saturation. You can set picture parameters for each channel based on scene.

Operation Description

Click **Sensor Setting** in the main menu or click menu of the channel management screen and choose **Sensor Setting** to access the Sensor Setting screen, as shown in Figure 7-9.

Figure 7-9 Sensor setting screen

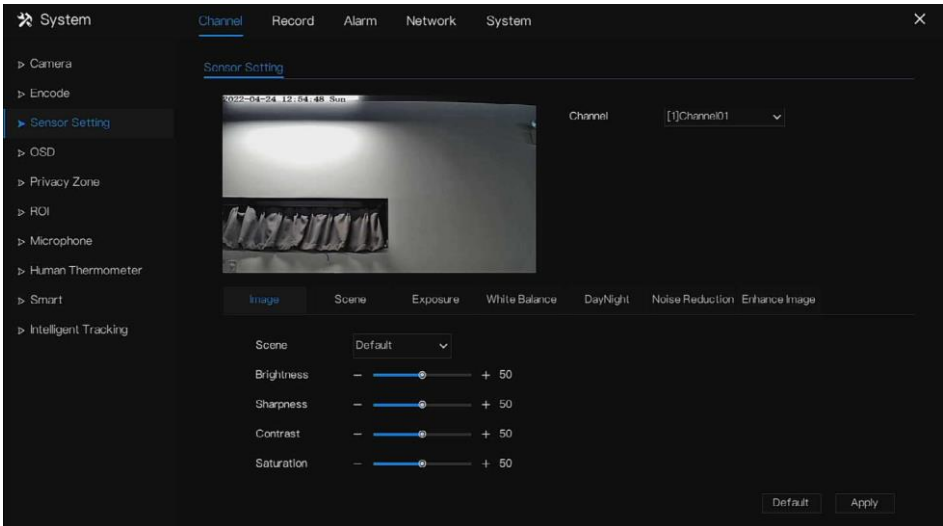

The Sensor Setting are as follows:

Brightness: it indicates brightness or darkness of an image.

Sharpness: it indicates picture's clarity.

Contrast: it refers to the brightest white and darkest black in an image.

Saturation: it indicates brilliance of the picture color.

Other parameters are sensor settings of IP cameras, like scene, exposure, white balance, day-night, noise reduction, enhance image, zoom focus, etc.

Scene: it includes indoor, outdoor, default. Mirror includes normal, horizontal, vertical, horizontal + vertical.

Exposure: it includes mode, max shutter, meter area and max gain.

White balance: it includes tungsten, fluorescent, daylight, shadow, manual, etc.

UI System Setting

Day-night: users can transit day to night, or switch mode.

Noise reduction: it includes 2D NR and 3D NR.

Enhance image: it includes WDR, HLC, BLC, defog and anti-shake.

Zoom focus: users can zoom and focus.

Operation Steps

Step 1 Select a channel from the drop-down list of channel.

Step 2 Select scene from the drop-down list. The default values of picture parameters vary with scenarios.

Step 3 Set parameters.

Step 4 Click **Default** to reset to factory settings, click **Apply** to save image settings.

----**End**

7.1.4 OSD Settings

Click **OSD** in the main menu or menu of the channel management screen and choose **OSD** to access the OSD screen, as shown in Figure 7-10.

Figure 7-10 OSD setting screen

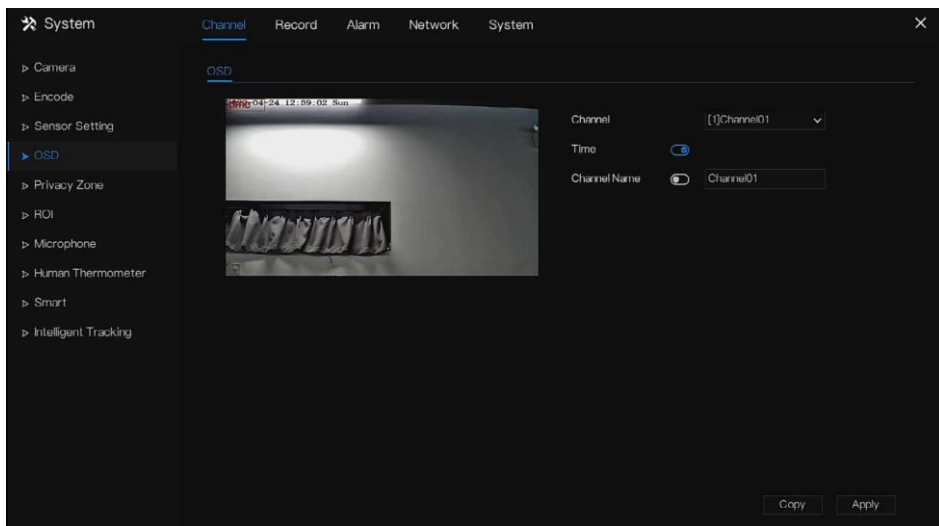

Operation Steps



Step 1 Select a channel from the drop-down list of channel.

Step 2 Click  next to Time to enable or disable OSD time setting.

Step 3 Click  next to Name to enable or disable OSD channel setting.

Step 4 Set the channel name.

Step 5 In the video window, click and drag time or channel to move to a location.

Step 6 Click  and select channels, then click  to apply the OSD settings to cameras in selected channels , click  to save OSD settings.

----End

7.1.5 Privacy Zone

The system allows you to mask images in a specified zone and which is called privacy zone.

Operation Description

Click **Privacy Zone** in the main menu or menu of the channel management screen and choose privacy zone to access the **Privacy Zone** screen, as shown in Figure 7-11.

Figure 7-11 Privacy zone screen

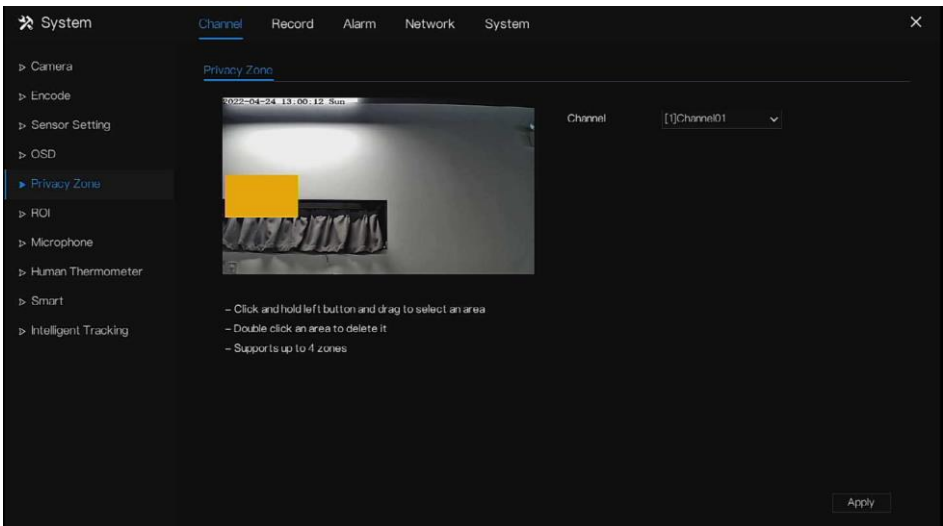

Operation Steps

Step 1 Select a channel from the drop-down list of channel.

UI System Setting

Step 2 In the video window, hold down and drag the left mouse button to draw a privacy area.

Step 3 Click **Copy** and select channels or tick **all**, then click **OK** to apply the privacy settings to cameras in selected channels , click **Apply** to save privacy settings.

Step 4 Double click privacy area to delete setting.

----End

7.1.6 ROI

Click **ROI** in the main menu or menu of the channel management screen and choose **ROI** to access the ROI screen, as shown in Figure 7-12.

Figure 7-12 ROI

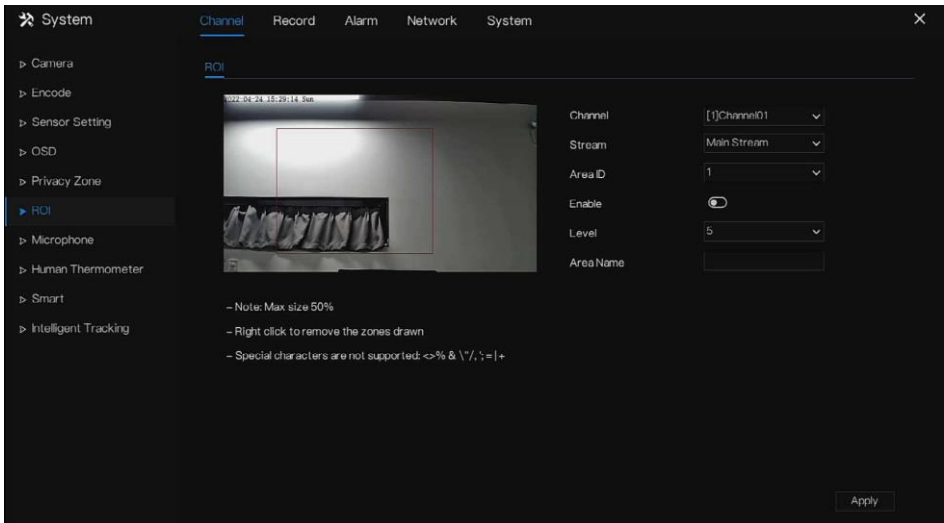

Table 7-1 RIO parameter

Parameter	Description	Setting
Stream	Stream ID.	[Setting method] Select a value from the drop-down list box. [Default value] Stream 1
Enable	Enable the ROI	[Setting method] Click the button. [Default value] OFF

Parameter	Description	Setting
Area ID	ROI area ID, there are 8 area	[Setting method] Select a value from the drop-down list box. [Default value] 1
Level	The measure result of ROI. The higher the grade, the clearer the area inside and the more vaguer the area outside. There are five levels.	[Setting method] Select a value from the drop-down list box. [Default value] 5
Area Name	The marked name used for areas.	[Setting method] Enter a value manually. The value cannot exceed 32 bytes.

----End

7.1.7 Microphone (Only for Some Models)

Click **Microphone** in the main menu or menu of the channel management screen and choose **Microphone** to access the Microphone screen, as shown in Figure 7-13.

Figure 7-13 Microphone

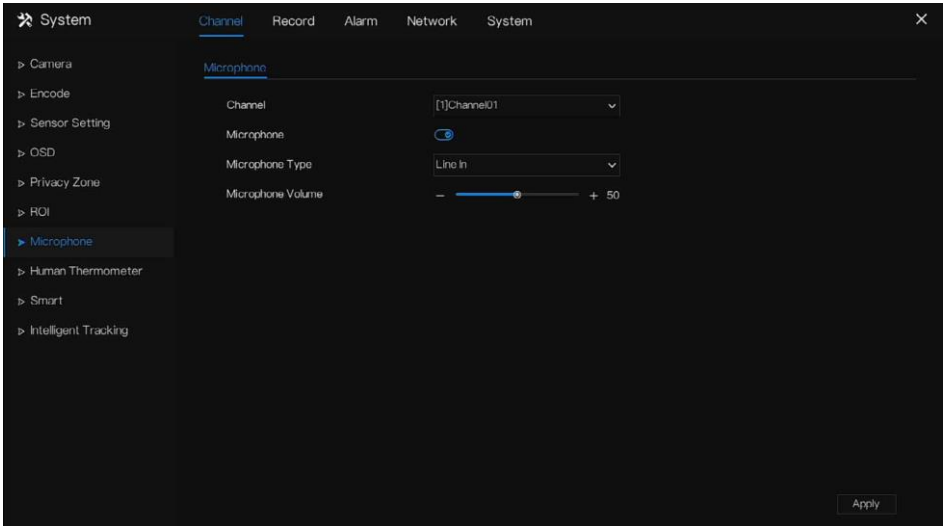

Table 7-2 Microphone

Parameter	Description	Setting
Enable Microphone	Indicates whether to enable the microphone function.	[Setting method] Click the button on to enable microphone.
Microphone Type	Microphone types include: Line In An active audio input is required.	[Setting method] Select a value from the drop-down list box.
Microphone Volume	Allows you to adjust the microphone volume.	[Setting method] Slide the slider left or right. [Default value] 50 NOTE The value ranges from 0 to 100.

---End

7.1.8 Human Thermometer (Only for Some Models)

Click **Human thermometer** in the main menu or menu of the channel management screen and choose **Human thermometer** to access the **Human thermometer** screen, as shown in Figure 7-14.

Figure 7-14 Human thermometer

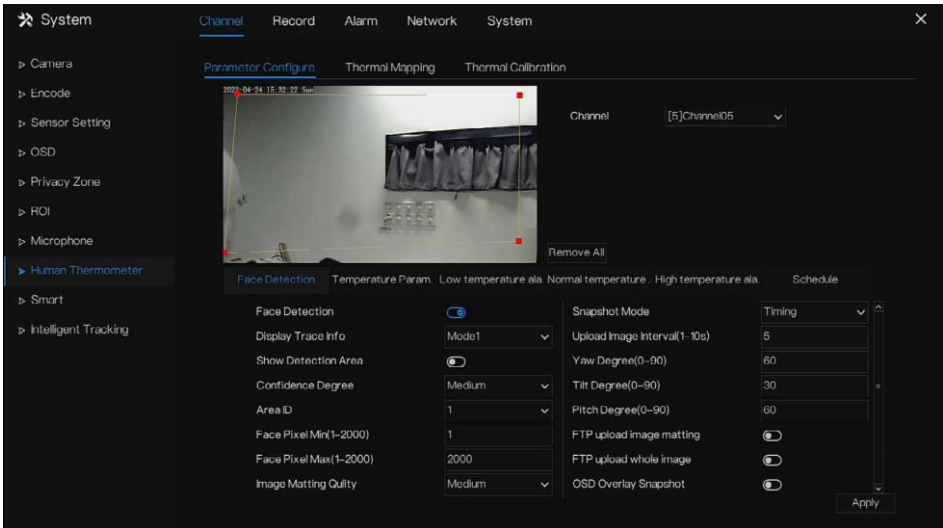

7.1.8.1 Parameter Configuration

Table 7-3 Human thermometer

Parameter	Description	Setting
Face detection	Detect face of human	[Setting method] Enable [Default value] On
Display trace	Display the information of tracing. OFF, mode 1 and mode 2	[Setting method] Enable the button [Default value] Mode 1
Show detection area	Enable, the live video will show area of detection.	[Setting method] Enable
Confidence coefficient	Face detection sensitivity, the value range is high, medium,	[Setting method]

UI System Setting

	low, the larger the value is, the higher the sensitivity. The higher the sensitivity value is, the higher the detection rate will be, but the more false detection may occur, such as the false detection of the patterns on pedestrian clothes to adult faces.	Choose from drop -list [Default value] Medium
Area ID	There are 8 areas can be set to detect temperature. Choose from the drop-list, left-click to draw the area, right-click to finish the set.	[Setting method] Choose from drop -list [Default value] 1
Face pixel min (1-2000)	When the pixel of the face in the image is less than the set value (the minimum pixel for face recognition), it is not captured.	[Setting method] Input a number from 1 to 2000 [Default value] 30
Face pixel max (1-2000)	When the pixel of the face in the image is more than the set value (the maximum pixel for face recognition), it is not captured.	[Setting method] Input a number from 1 to 2000 [Default value] 70
Image matting quality	The quality of snap image, There are three mode can be chosen, such as low, mid and high.	[Setting method] Choose from drop list. [Default value] Medium
Snapshot mode	There are two types, timing and optimal.	[Setting method] Choose from drop -list [Default value] Timing
Upload image interval	The snapshot mode is optimal, set the interval.	[Setting method] Input a number from 1 to 10 [Default value] 5
Snapshot count	At optimal mode, set the number of snapshot image	[Setting method] Input 1
Yaw degree(0-90)	Both eyes appear on the screen, offset in the left and right direction	[Setting method] Input a number from 0 to 90

		[Default value] 30
Tilt degree(0-90)	The face is deflected, and both eyes cannot appear in the picture.	[Setting method] Input a number from 0 to 90 [Default value] 30
Pitch degree(0-90)	Face is moving up and down	[Setting method] Input a number from 0 to 90 [Default value] 30
FTP upload image matting	Configuration > Network Service > FTP , set FTP related parameters, the captured picture will be sent to the set FTP location	[Default value] Disable
FTP upload whole image	Capture a picture and send a whole image.	[Default value] Disable
OSD over snapshot	Enable, the snapshots will record the temperature, as shown in figure. 	[Default value] Disable

Figure 7-15 Temperature parameters

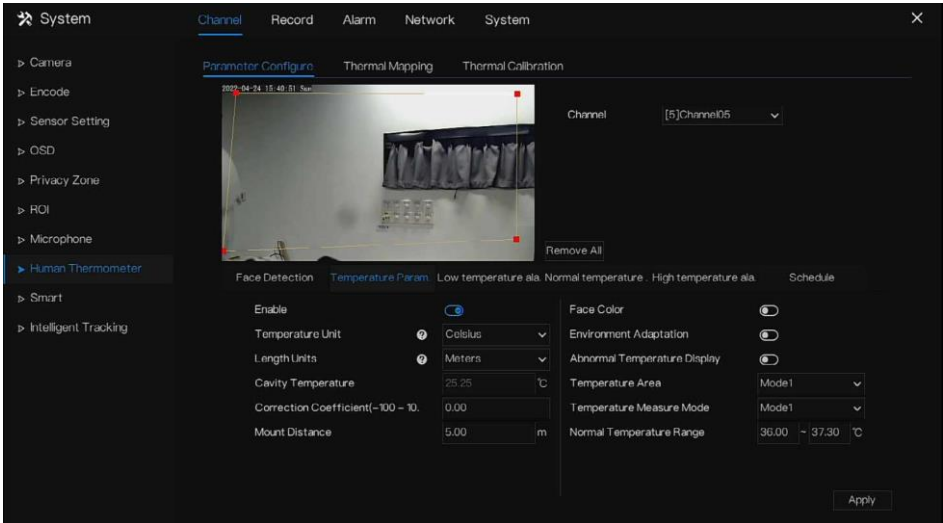



Table 7-4 Temperature parameters

Parameter	Description	Setting
Temperature Unit	Celsius and Fahrenheit temperature units are available. The unit is link to all temperature parameter, please modify the linkage value.	[Setting method] Select a value from the drop-down list box. [Default value] Celsius
Ambient Temperature	The ambient temperature of camera.	[Setting method] Enter a value manually.
Cavity Temperature	The cavity temperature of camera.	N/A

Parameter	Description	Setting
Correction Coefficient	<p>Correction coefficient refers to the deviation of measured object temperature and actual temperature.</p> <p>For example:</p> <ol style="list-style-type: none"> 1. The measured object temperature is 30, and actual temperature is 37, so the correction coefficient is 7. 2. The measured object temperature is 37, and actual temperature is 30, so the correction coefficient is -7. 	<p>[Setting method] Enter a value manually.</p> <p>[Default value] 0.00</p>
Mount distance	<p>The actual distance between the detection person and the device, it is set to facilitate the temperature measurement accuracy.</p>	<p>[Setting method] Select a value from the drop-down list box.</p> <p>[Default value] General</p>
Face color	<p>Enable, if the camera detect the face and the face will be covered color, normal is yellow, and high temperature is red, as shown in figure.</p> 	<p>[Default value] Disable</p>
Environment adaptation	<p>Enable, the device will restart the temperature if the ambient temperature of camera varies greatly. It is recommended not to open.</p>	<p>[Default value] Disable</p>
Abnormal temperature display	<p>Enable, the measure temperature is lower than 34 °C will show on OSD.</p> <p>Disable, the measure temperature is lower than 34 °C will not show on OSD.</p>	<p>[Default value] Disable</p>
Temperature area	<p>Two modes, shows at themal channel. Mode 1 is full face area, mode 2 is forehead area.</p>	<p>[Setting method] Select a value from the drop-down list box.</p> <p>[Default value] Mode 1</p>

UI System Setting

Parameter	Description	Setting
Temperature measure mode	Two modes, mode 1 is suitable for high air temperature, if the forehead temperature is less than 31 °C, not to show as body temperature. Mode 2 is suitable for low air temperature, if the forehead temperature is at 30-31 °C, so it will show as body temperature too.	[Setting method] Select a value from the drop-down list box. [Default value] Mode 1
Normal temperature range	Set the temperature range, when the detection is out of range, it will be alarming.	[Setting method] Enter a value manually. [Default value] 36 ~37.3

Low temperature alarm linkage / Normal temperature linkage / High temperature linkage: when the detection temperature is meet the setting, you can set the linkage action to alarm, as shown in Figure 7-16.

Figure 7-16 Linkage action

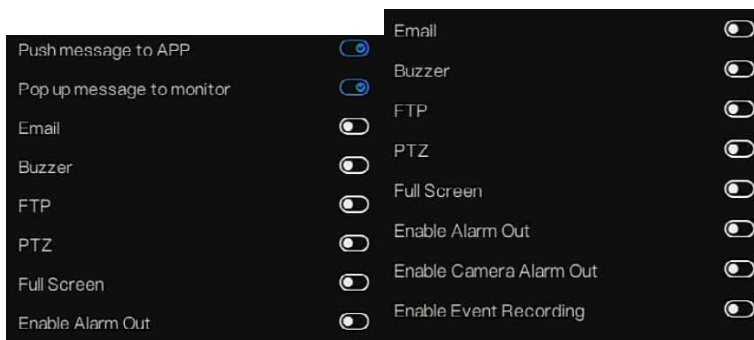

Set the alarm linkage schedule.

Click **Apply** to save the settings.

----**End**

7.1.8.2 Thermal Mapping

Figure 7-17 Thermal mapping

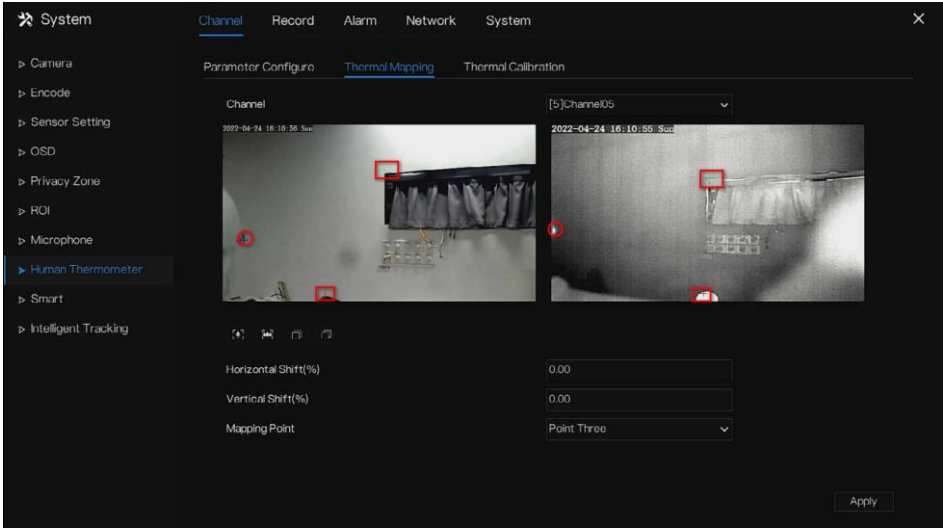



Table 7-5 Parameter of thermal mapping

Parameter	Description	Setting
	Zoom in /zoom out.	[Setting method] Click the button
	Near focus / far focus.	[Setting method] Click the button
Horizontal shift (%)	The points move small at horizontal direction.	[Setting method] Enter a value manually. [Default value] 0.00
Vertical shift (%)	The points move small at vertical direction.	[Setting method] Enter a value manually. [Default value] 0.00

Parameter	Description	Setting
Mapping point	<p>You need map three points at two channels. Points are correspond of each.</p> <p>The three points should cover most areas, and two points are located in the diagonal display of the picture.</p> <p>Point one is green cross.</p> <p>Point two is red cross.</p> <p>Point three is blue cross.</p>	<p>[Setting method]</p> <p>Select from drop list .</p>

7.1.8.3 Thermal Calibration

Figure 7-18 Thermal calibration

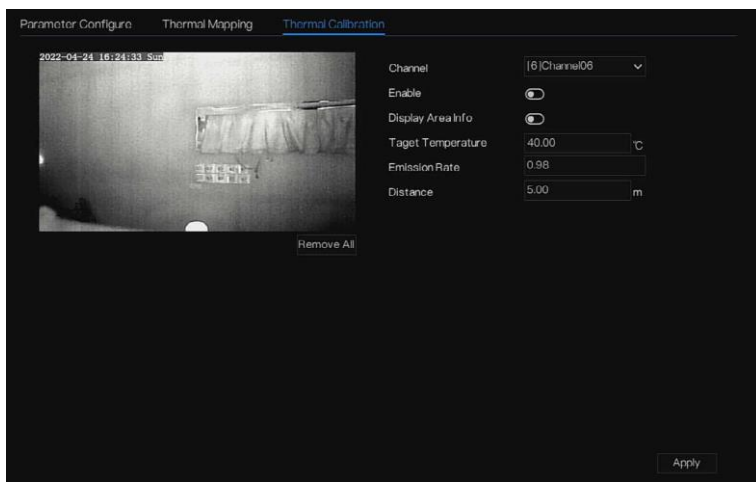

Table 7-6 Thermal calibration

Parameter	Description	Setting
Display area information	Enable to show the information of displaying area.	[Setting method] enable
Target temperature	The special calibration tool's temperature, it is general black body's target temperature.	[Setting method] Input value

Parameter	Description	Setting
Emission rate	Emission rate is the thermal calibration device's base parameter, the general blackbody's is 0.98.	[Setting method] Input value
Distance	Distance is the actual horizontal distance between measuring object and the camera	[Setting method] Input value

----End

7.1.9 Smart (Only for Some Models)



NOTE

It is only available for cameras with AI function.

The comparison function is only for AI multiobject cameras, please refer to actual cameras.

7.1.9.1 AI Multiobject

Figure 7-19 AI multiobject

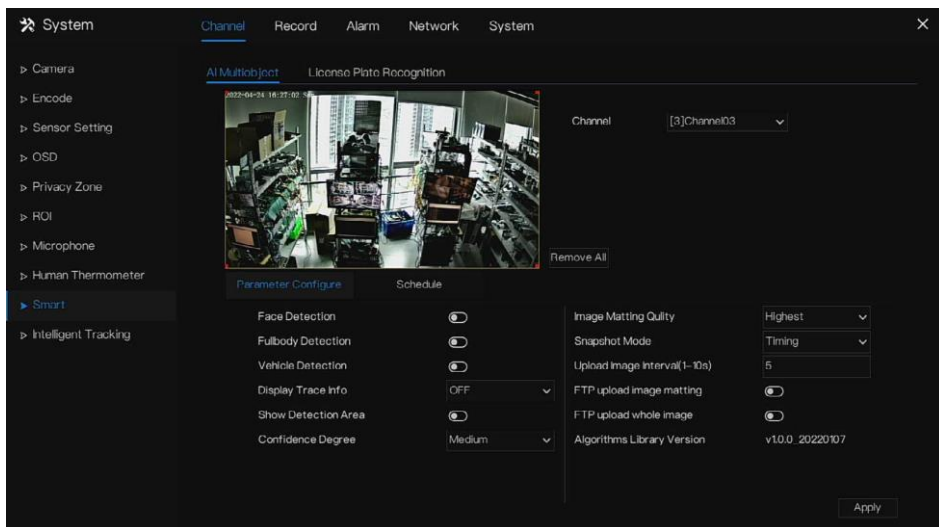

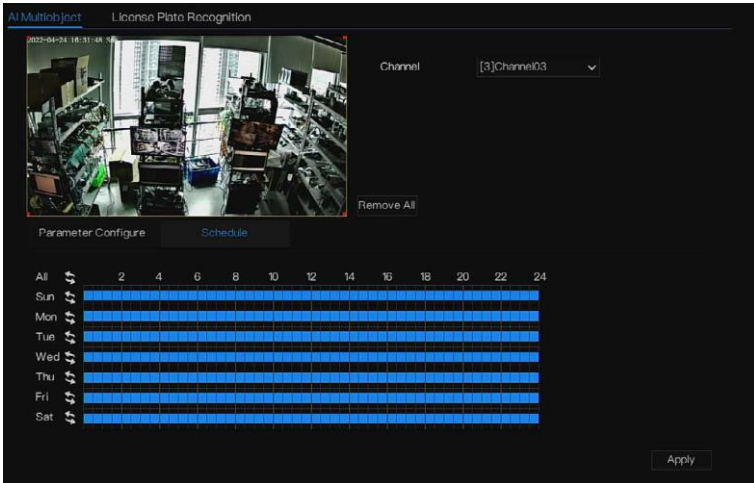

Table 7-7 AI multiobject

Parameter	Description	How to set
Face detection	The camera will snap the face when someone appears in live video.	Enable
Full body detection	The camera will snap the whole body when someone appears in live video.	Enable
Licence plate detection	The camera will snap the licence when the vehicle's licence appears in live video.	Enable
Vehicle detection	The camera will snap the licence when the vehicle appears in live video.	Enable
Display trace info	Enable the function and a trace frame will show at live video. Mode 1:  Mode 2: 	Choose from drop list.
Show detection area	Enable to set a detection area, and the frame will show at live video	Enable
Confidence	The range of snap image, there are three type,	Choose from drop-

Parameter	Description	How to set
coefficient	such as high, mid and low. The higher the confidence, the better the snap quality and the fewer snapshots.	down list.
Face pixel min(30-300)	30-300 pixels, the smaller the pixel be set, the more face will be captured, but it may be mistaken.	Input a value ranges 30 to 300
Body pixel min(30-300)	30-300 pixels, the smaller the pixel be set, the more body will be captured, but it may be mistaken.	Input a value range 30 to 300
Vehicle pixel min(30-800)	30-300 pixels, the smaller the pixel be set, the more face will be captured, but it may be mistaken.	Input a value range 30 to 800
Image matting quality	The quality of snap images, There are three modes can be chosen, such as low, mid and high.	Choose from drop list.
Snapshot mode	There are three modes can be chosen, such as timing, and optimal.	Choose from drop list.
Upload image interval(1-10 s)	At timing mode, set the interval of upload image.	Input a value ranges 1 to 10
FTP upload image matting	Configuration > Network Service > FTP , set FTP related parameters, the captured picture will be sent to the set FTP location	Enable
FTP upload whole image	Capture a picture and send a whole image.	Enable

Figure 7-20 Schedule



----End

7.1.9.2 License Plate Recognition

Figure 7-21 License plate recognition

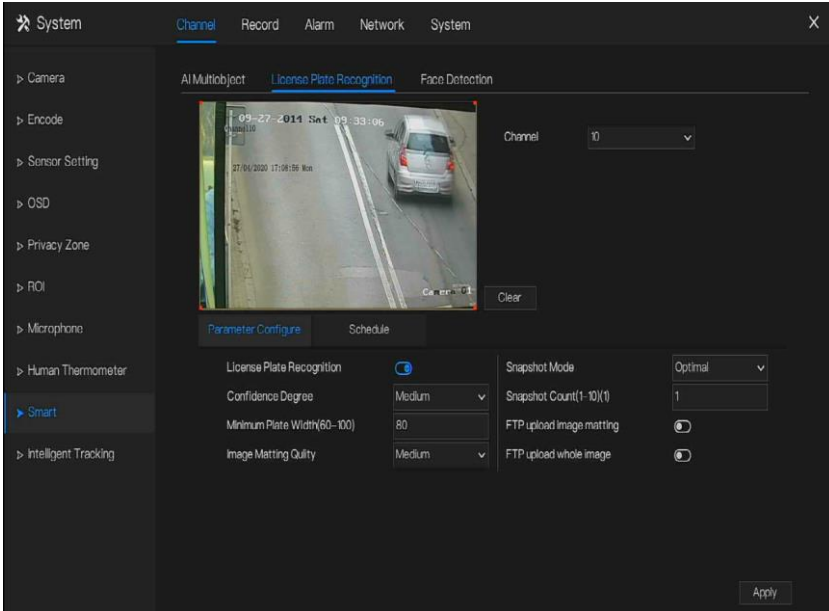

Table 7-8 License plate recognition

Function	Procedure	Description
Licence plate recognition	The camera will snap the face when someone appears in live video.	Enable
Confidence coefficient	The range of snap image, there are three type, such as high, mid and low. The higher the confidence, the better the snap quality and the fewer snapshots.	Choose from drop-down list.
Minimum plate width (60-100 Pixel)	60-100 pixels, the smaller the pixel, the more plates will be captured, but it may be wrong.	Input a value ranges 60 to 100
Image matting quality	The quality of snap image, There are three modes can be chosen, such as low, mid and high.	Choose from drop-down list.
Snapshot mode	There are three modes can be chosen, such as timing, and optimal.	Choose from drop-down list.
Upload image interval(1-10 s)	At timing mode, set the interval of upload image.	Input a value ranges 1 to 10
Snapshot count (1)	At optimal mode, set the number of snapshot image	Input 1
FTP upload image matting	Configuration > Network Service > FTP , set FTP related parameters, the captured picture will be sent to the set FTP location	Enable
FTP upload whole image	Capture a picture and send a whole image.	Enable

----End

7.1.10 Intelligent Tracking (Only for Some Models)

NOTE

This function is available for high speed camera.

The automatic target tracking function is that the dome camera can continuously track the moving target of the pre-made scene, and automatically adjusts the camera zoom focus according

UI System Setting

to the moving target distance, and the dome automatically returns to the preset scene when the moving target disappears.

Figure 7-22 Intelligent tracking

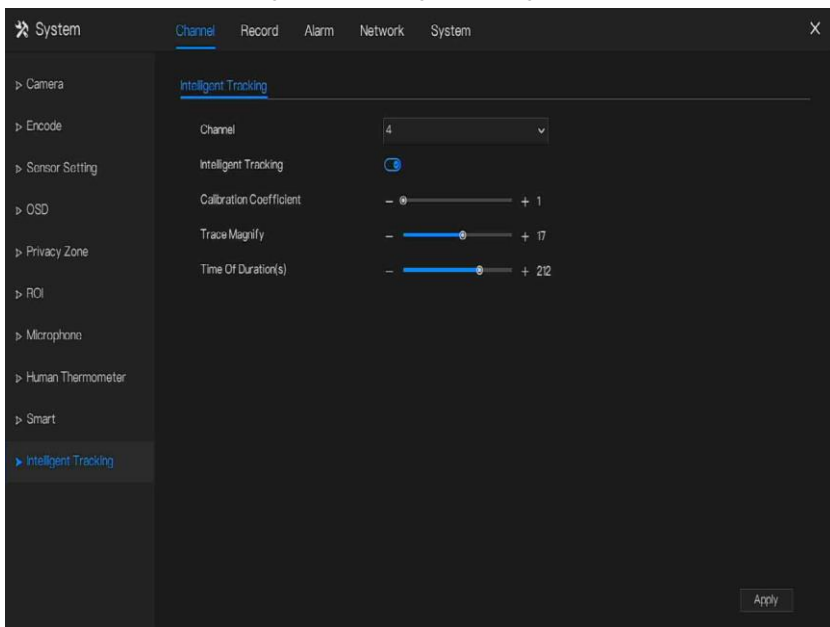

Table 7-9 Intelligent tracking parameters

Parameter	Description	Setting
Enable	Enable the button to enable the intelligent tracking	[How to set] Click Enable to enable. [Default value] OFF
Calibration Coefficient	It is equivalent to a control coefficient, and real-time tracking doubling rate nonlinear positive correlation, usually the higher the installation height, the greater the calibration coefficient value; it ranges from 1 to 30	[Setting method] Drag the slider. [Default value] 1
Trace Magnify	It is the value of lens zoom, it has a large influence on the real-time tracking magnification,	[Setting method] Drag the slider. [Default value] 7

Time of Duration	The maximum time of a tracking period, it ranges from 0 to 300 s.	[Setting method] Drag the slider. [Default value] 120
------------------	---	---

----End

7.2 Record Setting

Set the **Record Schedule**, **Disk**, **Storage Mode**, **S.M.A.R.T**, **Disk Detection**, **Disk Calculation**, **FTP** and so on.

7.2.1 Record Schedule

Operation Description

Click **Record** in the main menu or click the record page of any function screen in the main menu to access the record schedule screen, as shown in Figure 7-23.

Figure 7-23 Record management screen

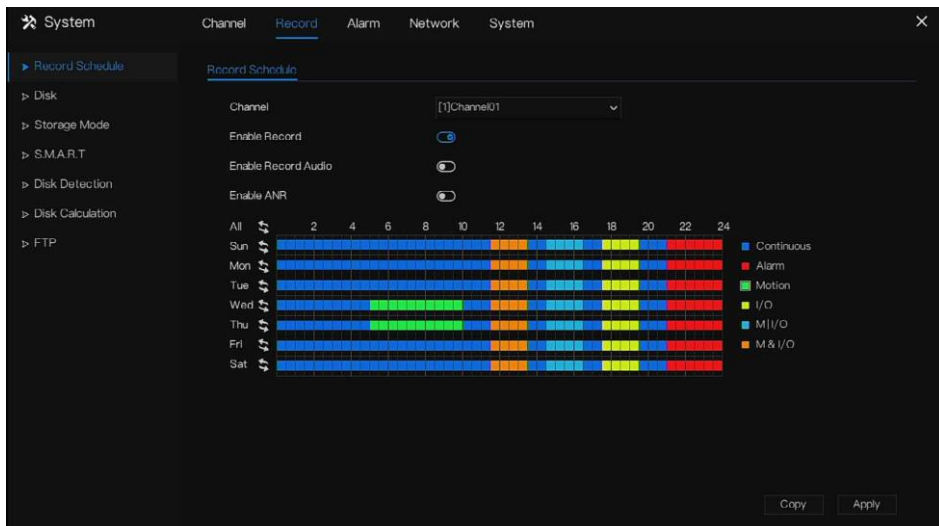

Operation Steps

Step 1 Select a channel from the drop-down list of channel option.

Step 2 Enable the record.

Step 3 Enable the record audio.

Step 4 Enable ANR, the camera is installed with SD card, if the camera is disconnected from the network, when the network is recovered, the NVR can read the recording of camera and copy the loss video form the SD card.

Step 5 Set the record schedule.

Method 1: Hold down the left mouse button, drag and release mouse to select the arming time within 00:00-24:00 from Monday to Sunday.

 **NOTE**

When you select time by dragging the cursor, the cursor cannot move out of the time area. Otherwise, no time would be selected.

The selected area is blue. The default is all week.



Users can choose alarm type to record, if the chosen alarm is happening at the setting time, it will record. So that it will using the disk effectively to avoid repeating useless recording.

The ANR function can be used only for the cameras with supplementary recording function.

Users can set different alarms to record.

Method 2: Click  in the record schedule page to select the whole day or whole week.

Step 6 Deleting record schedule: Click  again or inverse selection to delete the selected record schedule.

Step 7 Click  and select channels or tick **all**, then click  to apply the record management settings to selected channels , click  to save settings.

----End

7.2.2 Disk

View the total capacity of disk, disk status, disk SN code and storage space of disk. You can format the disk and set record expiration time.

Operation Description

Step 1 Click **Record** in the main menu or menu of the record screen and choose **Disk** to access the disk screen, as shown in Figure 7-24.

Figure 7-24 Disk screen

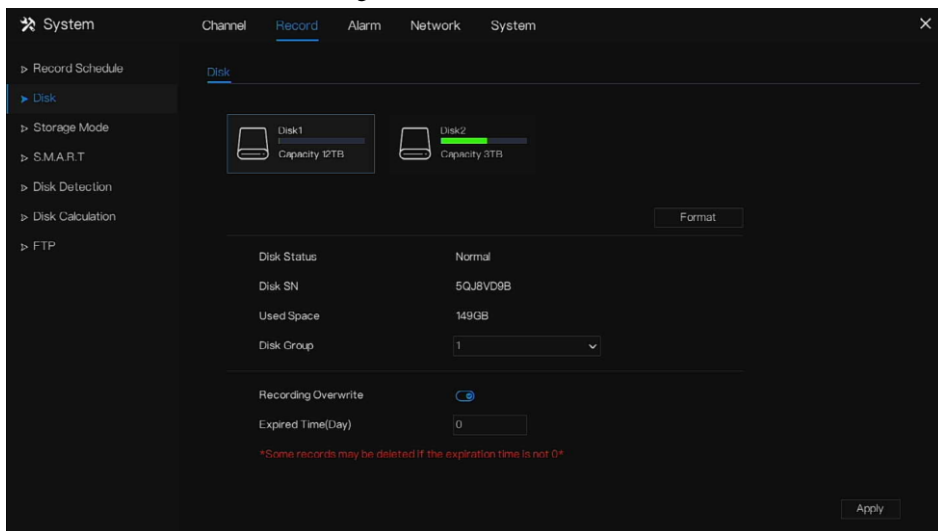

Step 2 Click **Format**. The message “Are you sure to format disk? Your data will be lost” is displaying.

Step 3 Choose the disk group, there are four groups.

Step 4 Click **OK**, and the disk would be formatted.

Step 5 Enable recording overwrite, the disk will be overwritten automatically.

Step 6 Record expiration setting. Select record expiration days from the drop-down list of record expiration. The expired time is not 0, the records will be deleted when the time is over the setting value.

Step 7 Click **Apply** to save the settings.

NOTE

The disk groups can keep the recording of channels at different disks, it will improve the storage efficiency.

The expired time is 0, it means the disk will be rewritten only when the disk is full.

---End

7.2.3 RAID (Only for Some Models)

The NVR support to build/ edit/ delete the RAID. Users can choose the type of RAID according to the importance of recording.

 **NOTE**

RAID is only used for the device with 4 disks or more. And the disks must be enterprise level disks.

The capacity of disks is the same for efficient using.

The maximum capacity of RAID cannot exceed 100T.

RAID5 at least 3 disks can be created. RAID6 at least 4 disks can be created. RAID10 at least 4 disks can be created. Create hot spare disk need more one disk or double basic disks.

The capacity of disks is the same for efficient using

Figure 7-25 RAID

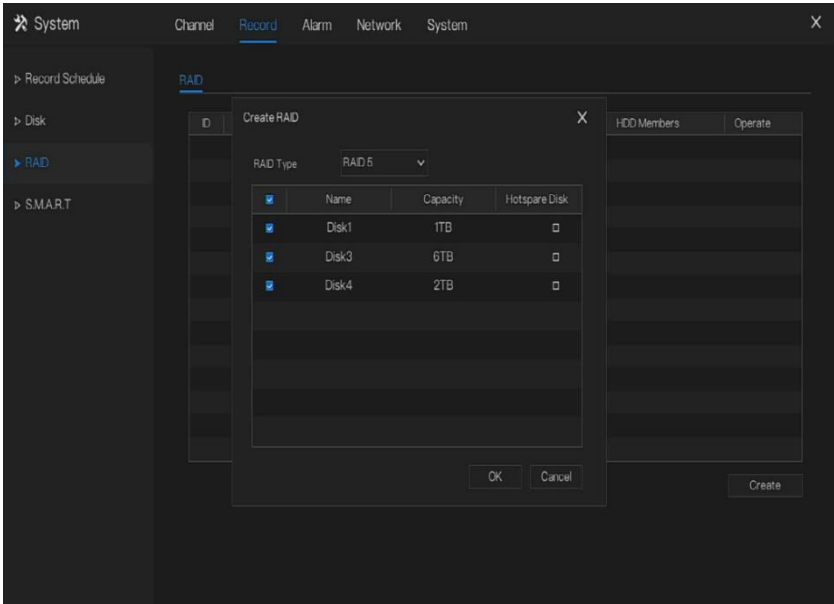

Operation Steps

Step 1 Click **RAID** to create the RAID.

Step 2 Click **Create** to choose a disk to create a new RAID.

UI System Setting

Step 3 Tick **Hot-spare Disk** to back up in case the disk is broken. The number of disk must be more than one.

Step 4 Click **OK** to save the creation, format the new RAID.

----End

7.2.4 Storage Mode

Users need to distribute the channels to different disk groups, and use disk capacity reasonably, as shown in Figure 7-26

Figure 7-26 Storage mode

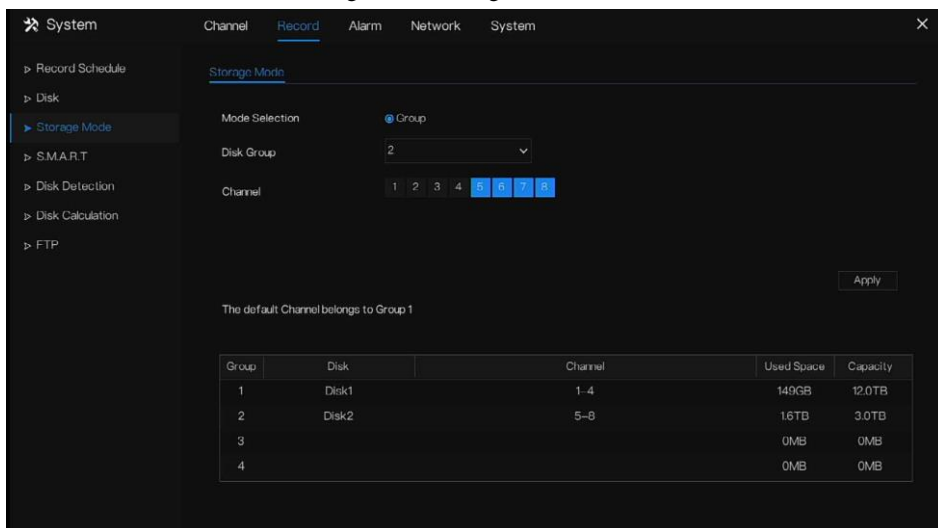

Operation Steps

Step 1 Choose the disk group.

Step 2 Select the channel to record to disk group.

Step 3 Click Apply to save the settings.

Step 4 The group list will show the detail information.

 **NOTE**

If the channels are not in list, it means NVR will not record these channels, please make sure that all channels are in list.

Choose number of channel number you should consider the capacity of disk group.

----End

7.2.5 S.M.A.R.T

7.2.5.1 S.M.A.R.T

S.M.A.R.T is Self-Monitoring Analysis and Reporting Technology, u which is able to check the disk as shown in Figure 7-27.

Figure 7-27 S.M.A.R.T

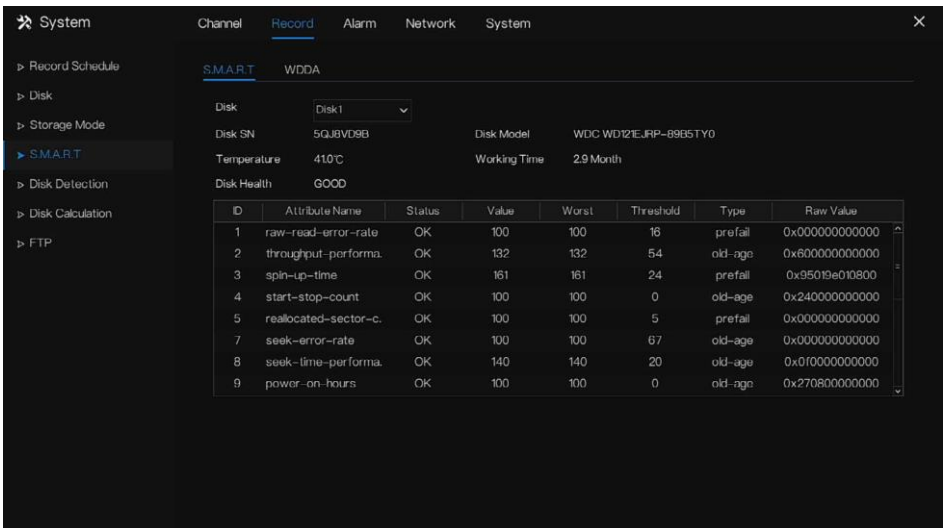

----End

7.2.5.2 WDDA

The western digital disk has the WDDA function, the NVR can read the information of disk, so that users can view the status of disk, as shown in Figure 7-28.

Figure 7-28 WDDA

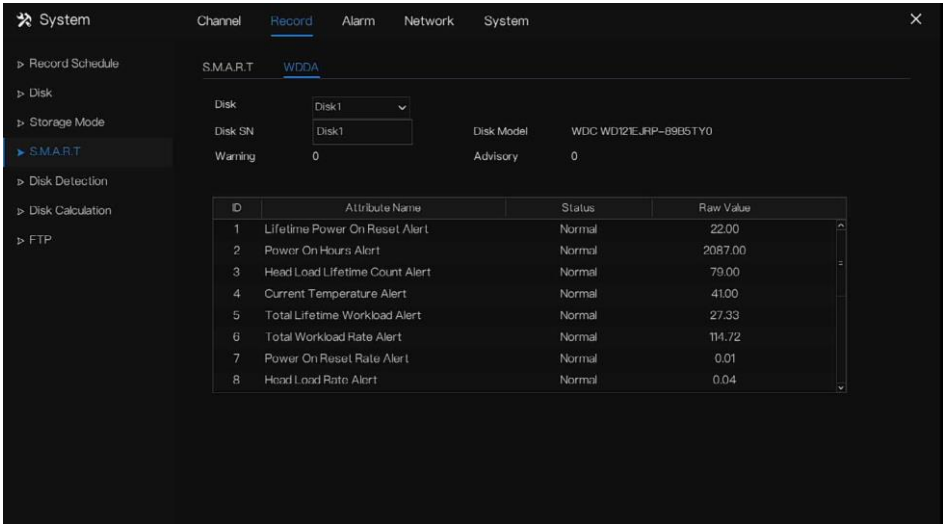

----End

7.2.6 Disk Detection

Detect the disk before recording videos so that the data are secure as shown in Figure 7-29.

Figure 7-29 Disk Detection

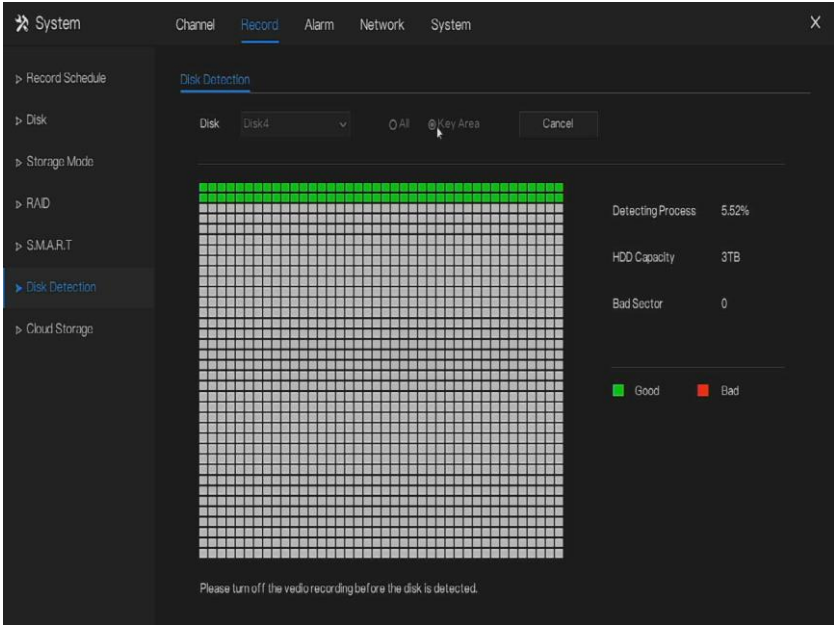

Operation Steps

Step 1 Choose the disk from the drop-down list.

Step 2 Tick **All** or **key Area** to detect the disk. It will take some several minutes.

Step 3 Click Scan to scan the disk.

Step 4 The result of disk will show in interface

NOTE

The green block means good, the red block means bad, if the red blocks are too much or at key section, please change the disk immediately.

Please turn off the video recording before the disk is detected, otherwise the recording of video maybe lost.

----End

7.2.7 Cloud Storage (Only for Some Models)

The cloud storage can save the motion detection and intelligent analysis alarm Support Google Drive.

Figure 7-30 Cloud Storage

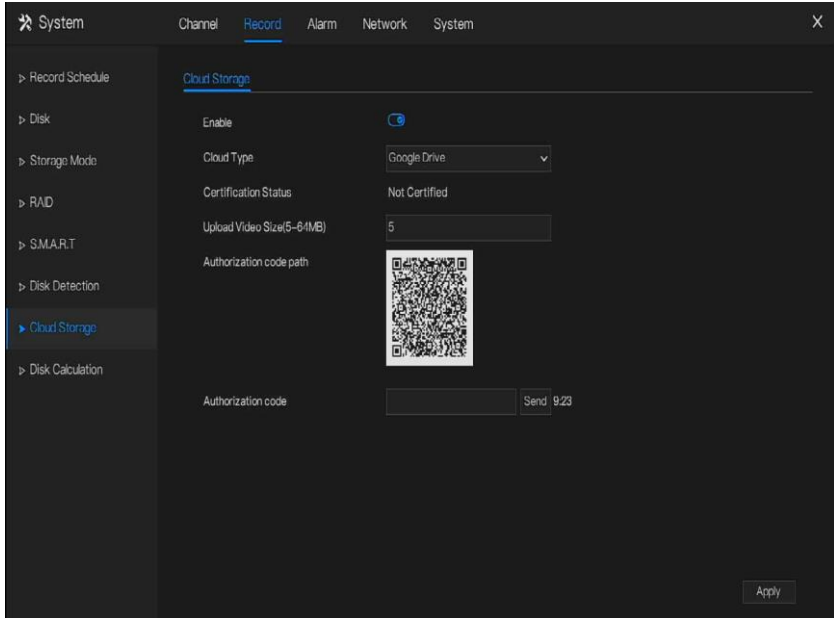

Operation Steps

Step 1 Enable the cloud storage, and the UUID of code path will show.

Step 2 Choose the cloud type, the default is Google cloud.

Step 3 Set upload video size, the video is saving in sub stream(the video size is less).

Step 4 Use browser to scan the UUID to jump to Google drive certification, input the account and password to certificate the NVR.

Step 5 Input the code , click Send to fish certificate, as shown in Figure 7-31.

Figure 7-31 Certification

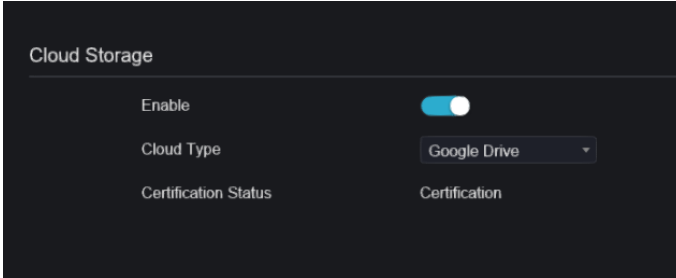

Step 6 Click Apply to save the settings

 **NOTE**

Google Cloud only needs to be authenticated once, without multiple authentications. After the authentication is completed, the cloud storage function can be turned on or off as required.

This function needs to be re-certified after the device is restored to factory settings.

The UUID is the path of Google drive.

---End

7.2.8 Disk Calculation

Users can calculate the usage of disk, so that he can set the storage strategy reasonably, as shown in Figure 7-32.

There are two modes can be set, computing capacity and computing time

Figure 7-32 Disk calculation of capacity

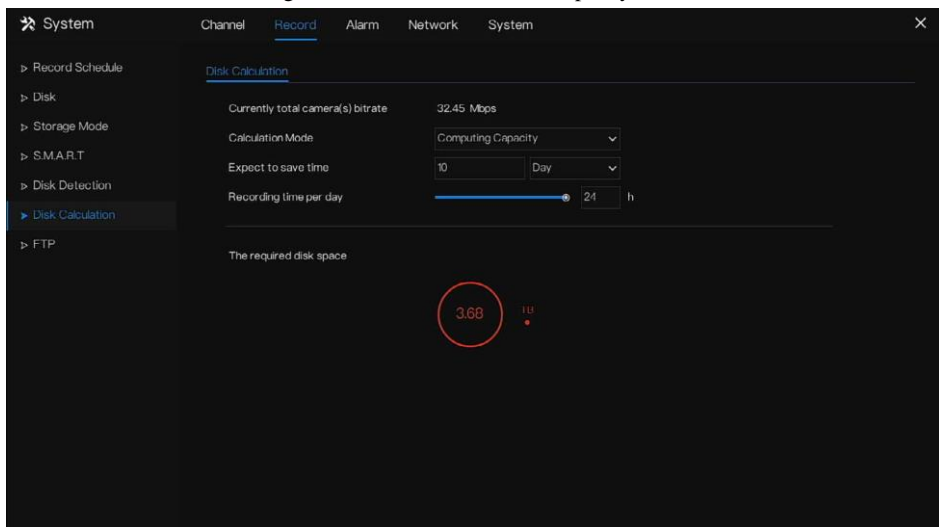
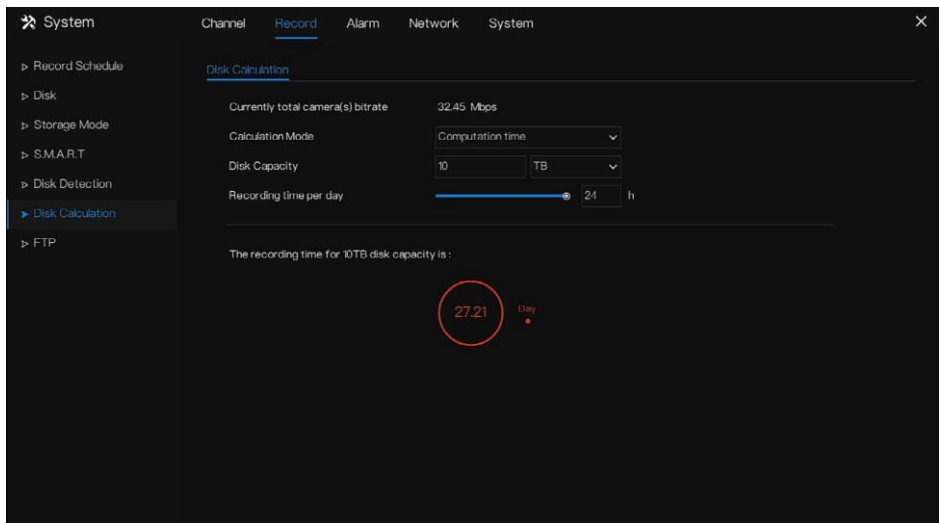

Figure 7-33 Disk calculation of time



----End

7.2.9 FTP

Enable FTP upload, when the alarm happens, users can linkage the FTP upload to save the alarm recordings.

Figure 7-34 FTP

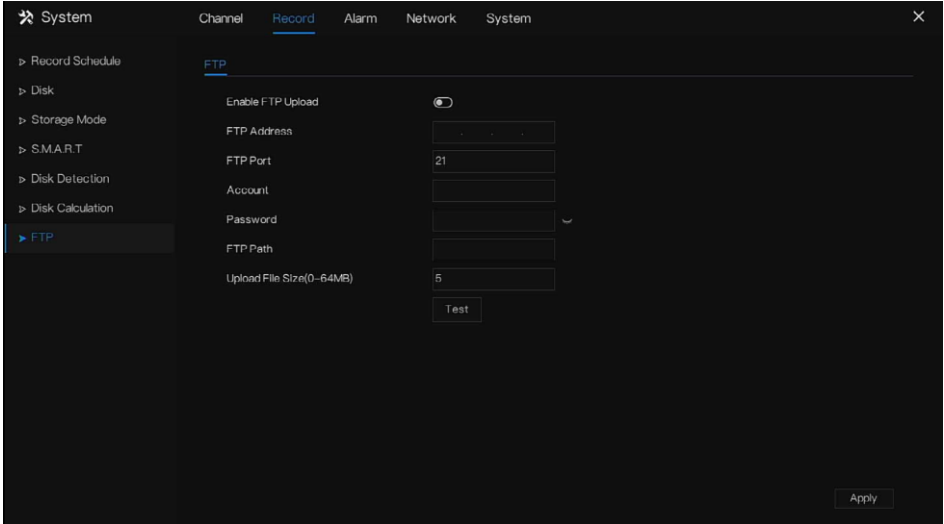

Step 1 Enable the FTP upload.

Step 2 Input the FTP address and port.

Step 3 Input the account, password and FTP path.

Step 4 Set the upload file size, it ranges from 0 to 64 MB.

Step 5 Click “Test” to test the parameters. After the test is successful, click "Apply" to save the settings

----End

7.3 Alarm Management

Set the **General alarm information, Motion Detection, Video Loss, Intelligent Analysis, Alarm In, Abnormal Alarm, Alarm out** and **Local intelligent analysis** in alarm management screen.

7.3.1 General

7.3.1.1 General

Step 1 Click **Alarm** in the main menu (or click the alarm page of any function screen in the main menu) to access the alarm management screen, as shown in Figure 7-35.

Figure 7-35 Alarm management screen

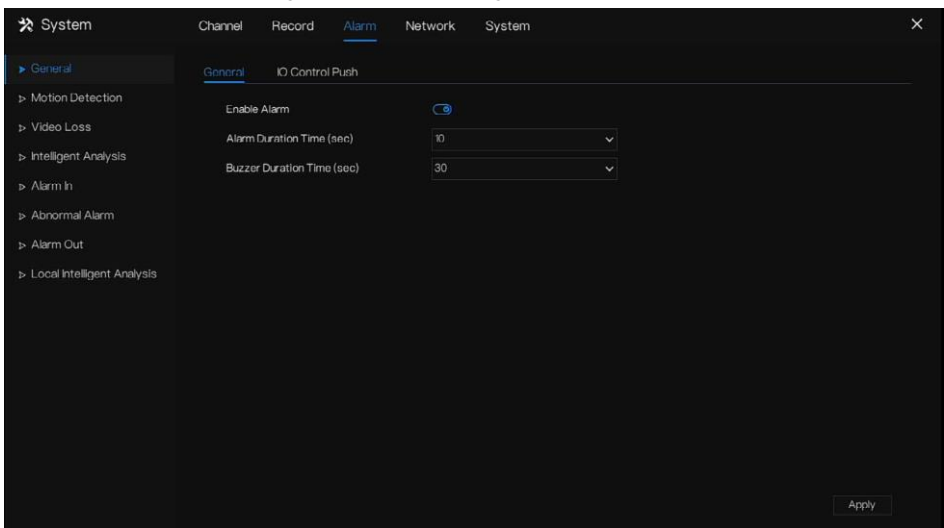

Step 2 Click to enable the alarm function.

Step 3 Select a value from the drop-down list of duration time.

Step 4 Click **Apply** to save alarm settings.

----End

7.3.1.2 IO control push

If you select normally open and tick the disabled items, the alarm input 1 will not push message. Only when the alarm in 1 is in the normally closed, it can push alarm message.

Step 1 Enable the IO control push.

Figure 7-36 IO control push

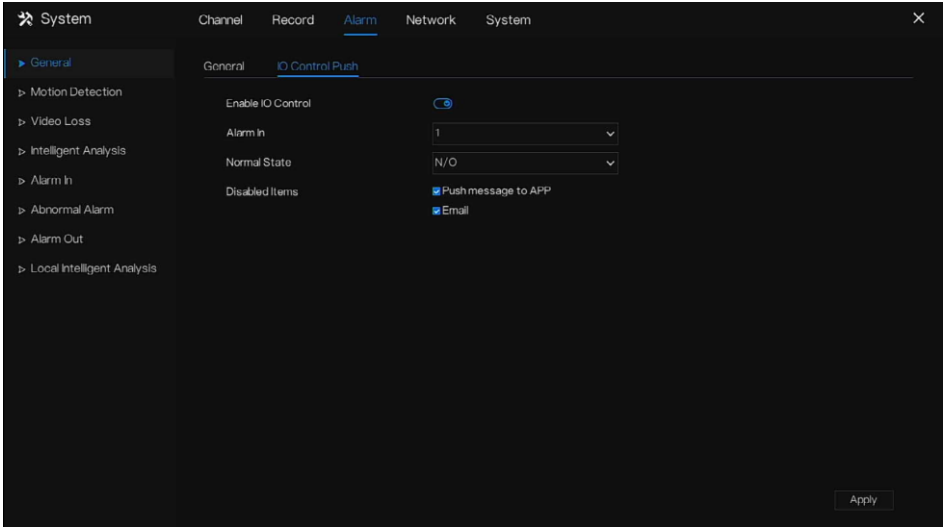

Step 2 Choose one alarm in and mode(N/C, N/O).

Step 3 Tick the disable items, click “Apply” to save settings.

----End

7.3.2 Motion Detection

The NVR will send motion detection alarm while something moving in the specific view of camera.

Operation Description

Step 1 Click **Motion Detection** in the main menu or menu of the alarm management screen and choose **Motion Detection** to access the Motion Detection screen, as shown in Figure 7-37.

Figure 7-37 Motion detection screen

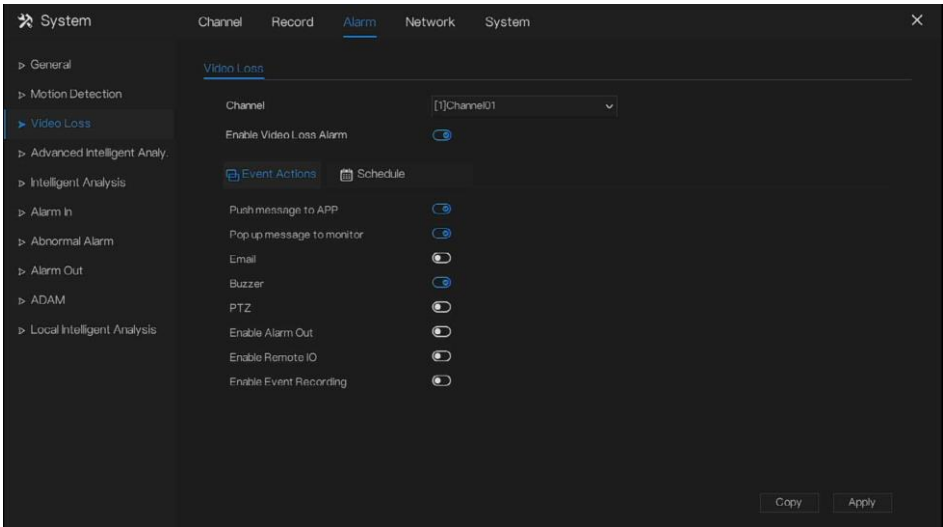

NOTE

For Email, FTP, you should set the parameters of these in advance.

Enable Remote IO, the users connect the ADAM (data acquisition modules) to NVR in advanced.

Alarm time, the alarm will be duration. Remote ID, the ADAM is connected to NVR'S ID.

Port number, the alarm device is plugged to ADAM's ID. elation Steps

Step 1 Select a channel from the drop-down list of channel.

Step 2 Click  to enable motion detection.

Step 3 Enable motion analysis if the camera detects the motion action, the area will be block as shown in Figure 7-38.

Step 4 Enable the Event actions include: push messages to App, pop up messages to monitor, send Email, buzzer, FTP, PTZ, full screen, alarm out, camera alarm out, enable remote IO, event recordings and so on.

Step 5 Click Area page to access the motion detection area setting, as shown in Figure 7-38.

Figure 7-38 Motion detection area setting screen

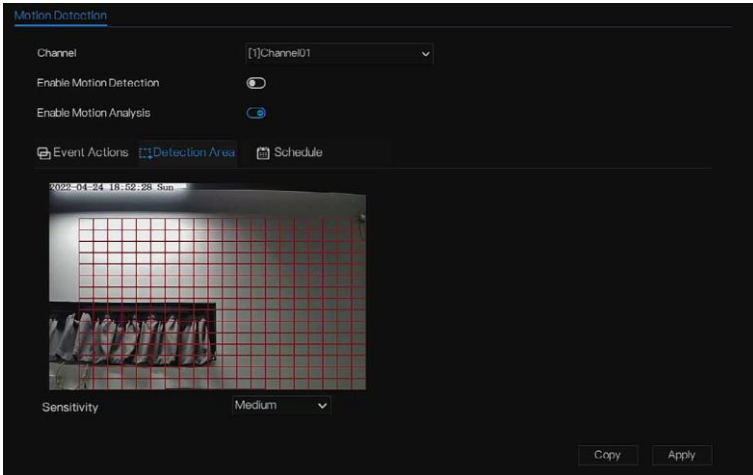

Area :

1. Hold down and drag the left mouse button to draw a motion detection area.
2. Select a value from the drop-down list next to **Sensitivity**.

Step 6 Click **Schedule** page to access the schedule screen. For details, please see 7.2.1 Record Schedule Figure 7-23 Step 5 Set the record schedule.

Step 7 Click **Copy** and select channels or tick **all**, then click **OK** to apply the motion detection settings to cameras in selected channels, click **Apply** to save motion detection alarm settings.

 **NOTE**

Double click to delete the selected area.

The default area is whole area.

If you leave the page without applying, the tip “Do you want to save?” would show. Click save to save the settings. Click cancel to quit the settings.

Enable the alarm out, users need to set alarm time and output ID, four ID are corresponding to back panel’s alarm out, 1 A and 1 B, 2 A and 2 B, 3 A and 3 B, 4 A and 4 B.

Channel alarm out is corresponding to alarm port of camera.

Figure 7-39 Alarm schedule

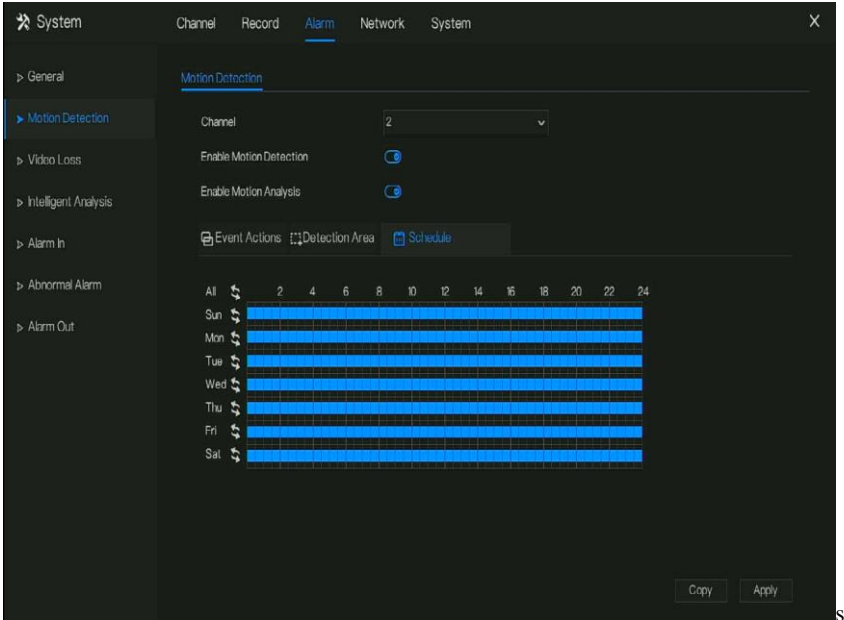

----End

7.3.3 Video Loss

If a camera is disconnected to NVR, it will trigger video loss alarm.

Operation Description

Click **Video Loss** in the main menu or menu of the alarm management screen and choose **video Loss** to access the video loss screen, as shown in Figure 7-40.

Figure 7-40 Video loss screen

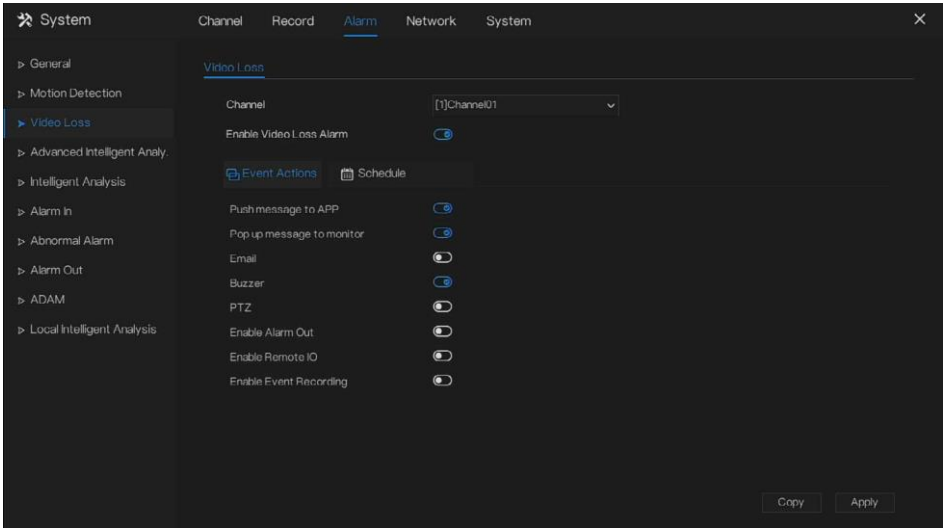

Operation Steps

Step 1 Select a channel from the drop-down list of channel.

Step 2 Click to enable video loss alarm.

Step 3 Enable the Event actions include: push message to App, pop up message to monitor, send Email, buzzer, FTP, PTZ, alarm out, enable remote IO, event recording and so on.

Step 4 Click Schedule page to access the schedule screen.

Step 5 For details, please see 7.2.1 Record Schedule *Figure 7-23* Step 5 Set the record schedule.

Step 6 Click and select a channel, then click to apply the parameter settings to cameras in selected channels, click to save video loss settings.

----End

7.3.4 Advanced Intelligent Analysis (Only for Some Models)

 **NOTE**

The channel camera can set the advanced intelligent analysis which are thermal image cameras or bi-spectral spectrum cameras.

At advanced intelligent analysis interface, users can set the parameters of smoker detection, smoke and flame detection, fire spot detection. Enable the linkage actions, the alarm information can be sent to user by the linkage.

The advanced intelligent analysis can be used for detecting the smoking, if someone smoke in the indoor where is forbidden smoking.

Smoke and Flame Detection can be used for detecting smoke and fire, it can be sent alarm information to avoid fire getting worse.

Fire Spot Detection can be used for finding the catching fire to quickly operate to extinguish.

7.3.4.1 Smoker Detection

The smoker detection function refers to that an alarm is generated when someone is smoking or generating spark at the deployment area.

Figure 7-41 Smoker Detection

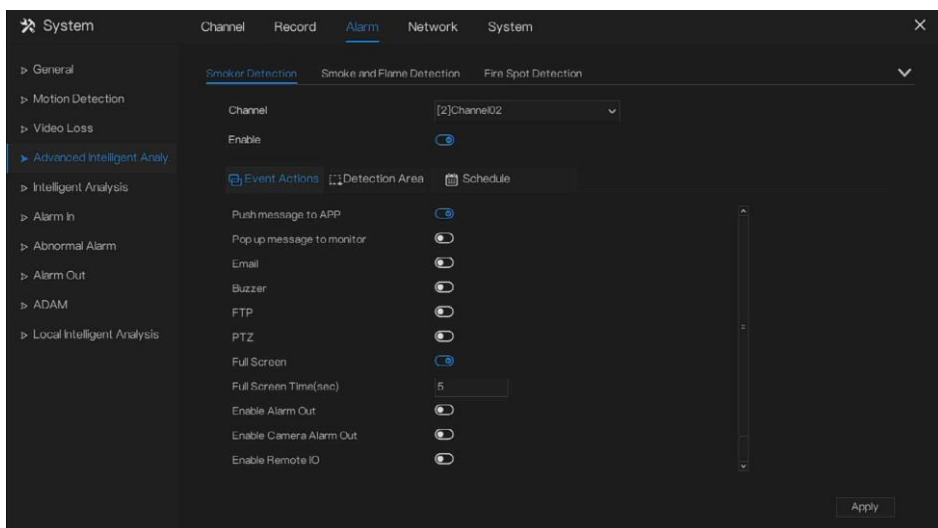

Parameter	Description	Setting
Channel	Choose thermal image camera from the drop-down list.	[How to set] Choose from the drop-down list
Enable	At thermal channel, Enable the button to enable the alarm.	[How to set] Click button to enable. [Default value] OFF
Linkage action	Push message to App, Pop up message to monitor, Email, Buzzer, FTP, PTZ, Full screen, Enable alarm out, Enable Camera Alarm out, Enable Remote IO, Enable Event Recording.	[How to set] Click button to enable. [Default value] OFF
Sensitivity	The sensitivity of detecting smoker, when the value is high, the alarm can be triggered easily, but the accuracy will be lower.	[How to set] Choose from the drop-down list. [Default value] 5
Audio detection alarm	Enable, when happen the alarm, it will play audio to alarm. Choose the sound alarm file (set at the “ Configuration > Alarm > Sound Alarm Output ”).	[How to set] Click to enable Audio Detection Alarm [Default value] OFF
Flashlight alarm	Enable, when it is triggered alarm, it flashes the light. But when users set the display mode to Mode 5 at “ Configuration > Thermal > Led Control Param ” interface, the light will be always on for 15s, not flash when it is alarm.	[How to set] Click to enable Flashlight Alarm. [Default value] OFF
Video Stream Draw Line	Enable the button to enable Video Stream Draw Line, the setting area frame will show on live video.	[How to set] Click to enable Video Stream Draw Line. [Default value] OFF

Figure 7-42 Smoker Detection – Detection Area

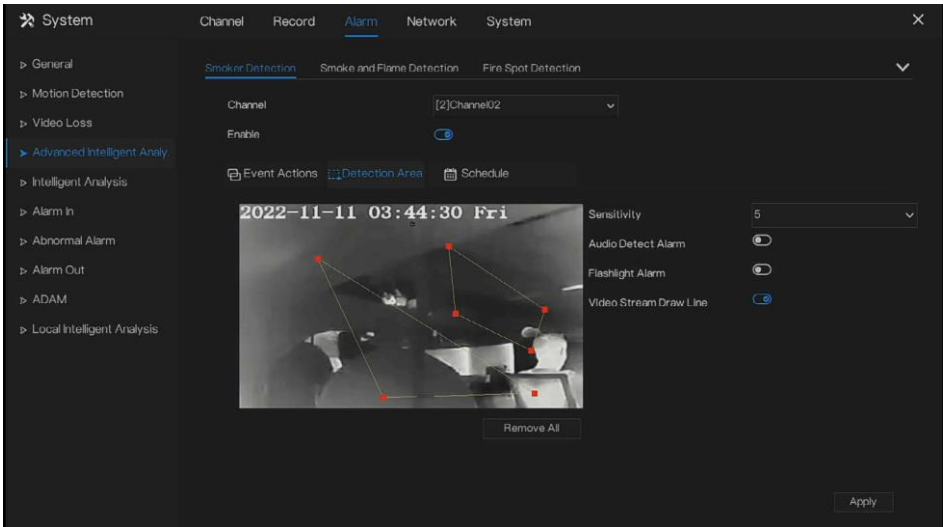

Set a deployment area. Move the cursor to the drawing interface and click to generate a point, move the cursor to draw a line, and then click to generate another point. This is how a line is generated. In this way, continue to draw lines to form any shape, and right-click to finish line drawing.

NOTE

- A drawn line cannot cross another one, or the line drawing fails.
- Any shape with 32 sides at most can be drawn.
- The quantity of deployment areas is not limited yet and will be described in future when a limit is applied.

Figure 7-43 Smoker Detection – Detection schedule

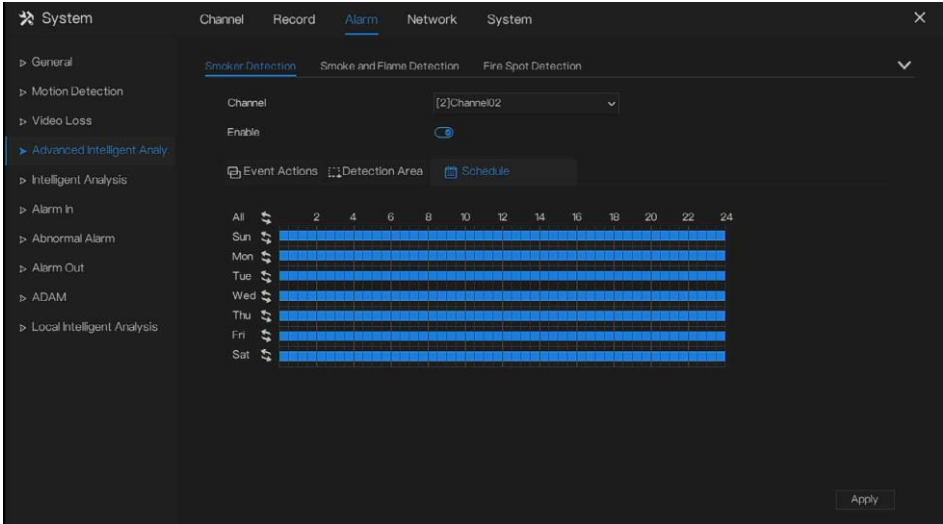

Method 1: Click left mouse button to select any time point within 0:00-24:00 from Monday to Sunday.

Method 2: Hold down the left mouse button, drag and release mouse to select the deployment time within 0:00-24:00 from Monday to Sunday.

Method 3: Click  in the deployment time page to select the whole day or whole week.

 **NOTE**

- When you select time by dragging the cursor, the cursor cannot be moved out of the time area. Otherwise, no time can be selected.

Deleting deployment time: Click  again or inverse selection to delete the selected deployment time.

7.3.4.2 Smoke and Flame Detection

The smoke flame detection function refers to that an alarm is generated when something is smoking or generating flame at the deployment area.

Figure 7-44 Smoke and Flame Detection

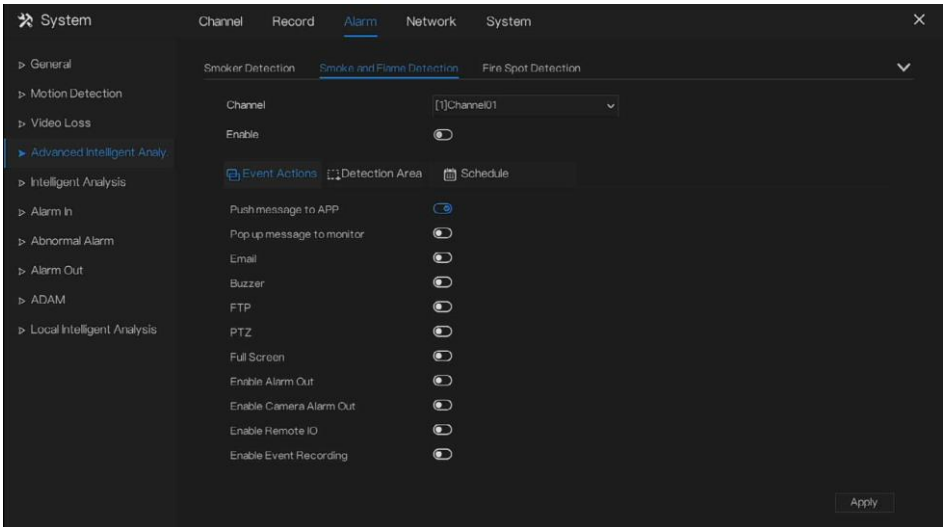

Parameter	Description	Setting
Channel	Choose visible channel of bispectral spectrum camera from the drop-down list.	[How to set] Choose from the drop-down list
Enable	At thermal channel, Enable the button to enable the alarm.	[How to set] Click Enable to enable. [Default value] OFF
Linkage action	Push message to App, Pop up message to monitor, Email, Buzzer, FTP, PTZ, Full screen, Enable alarm out, Enable Camera Alarm out, Enable Remote IO, Enable Event Recording.	[How to set] Click button to enable. [Default value] OFF
Sensitivity	The sensitivity of detecting smoker, when the value is high, the alarm can be triggered easily, but the accuracy will be lower.	[How to set] Choose from the drop-down list. [Default value] 5

Parameter	Description	Setting
Audio detection alarm	Enable, when happen the alarm, it will be play audio to alarm. Choose the sound alarm file (set at the “ Configuration > Alarm > Sound Alarm Output ”).	[How to set] Click to enable Audio Detection Alarm [Default value] OFF
Flashlight alarm	Enable, when it is triggered alarm, it flashes the light. But when users set the display mode to Mode 5 at “ Configuration > Thermal > Led Control Param ” interface, the light will be always on for 15s, not flash when it is alarm.	[How to set] Click to enable Flashlight Alarm. [Default value] OFF
Video Stream Draw Line	Enable the button to enable Video Stream Draw Line, the setting area frame will show on live video.	[How to set] Click to enable Video Stream Draw Line. [Default value] OFF

Figure 7-45 Smoke and Flame Detection – Detection Area

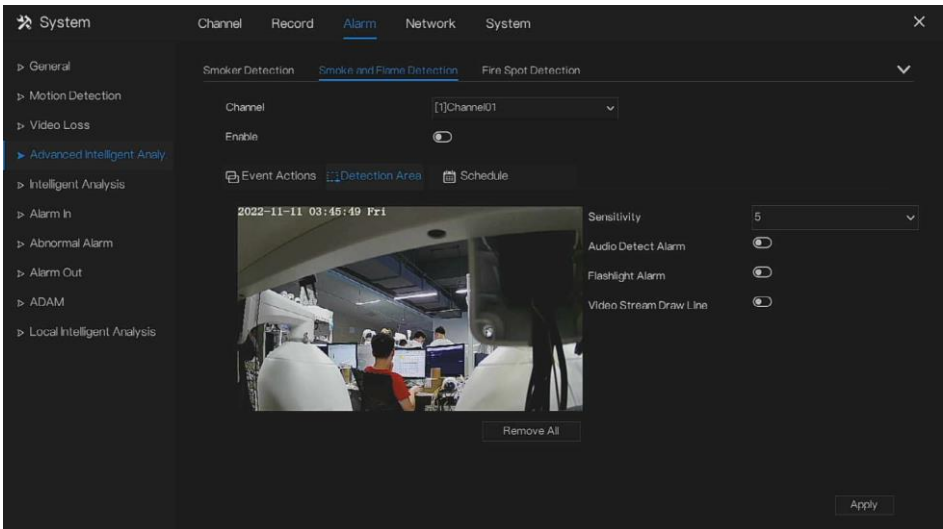

Set a deployment area. Move the cursor to the drawing interface and click to generate a point, move the cursor to draw a line, and then click to generate another point. This is how a line is

generated. In this way, continue to draw lines to form any shape, and right-click to finish line drawing.

NOTE

- A drawn line cannot cross another one, or the line drawing fails.
- Any shape with 32 sides at most can be drawn.
- The quantity of deployment areas is not limited yet and will be described in future when a limit is applied.

Figure 7-46 Smoke and Flame Detection – Schedule

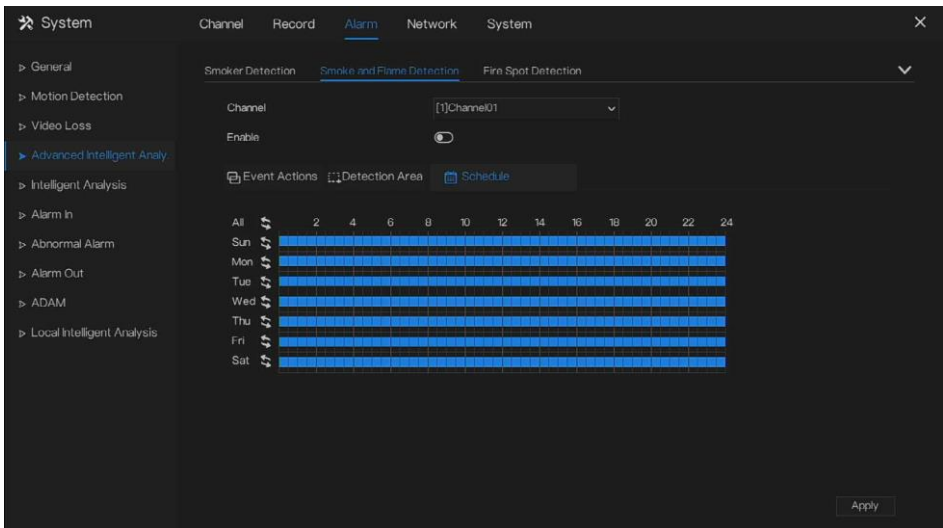

Method 1: Click left mouse button to select any time point within 0:00-24:00 from Monday to Sunday.

Method 2: Hold down the left mouse button, drag and release mouse to select the deployment time within 0:00-24:00 from Monday to Sunday.

Method 3: Click  in the deployment time page to select the whole day or whole week.

 **NOTE**

- When you select time by dragging the cursor, the cursor cannot be moved out of the time area. Otherwise, no time can be selected.

Deleting deployment time: Click  again or inverse selection to delete the selected deployment time.

7.3.4.3 Fire Spot Detection

The fire spot detection function refers to that an alarm is generated when something starting fire at the deployment area.

Figure 7-47 Fire Spot Detection

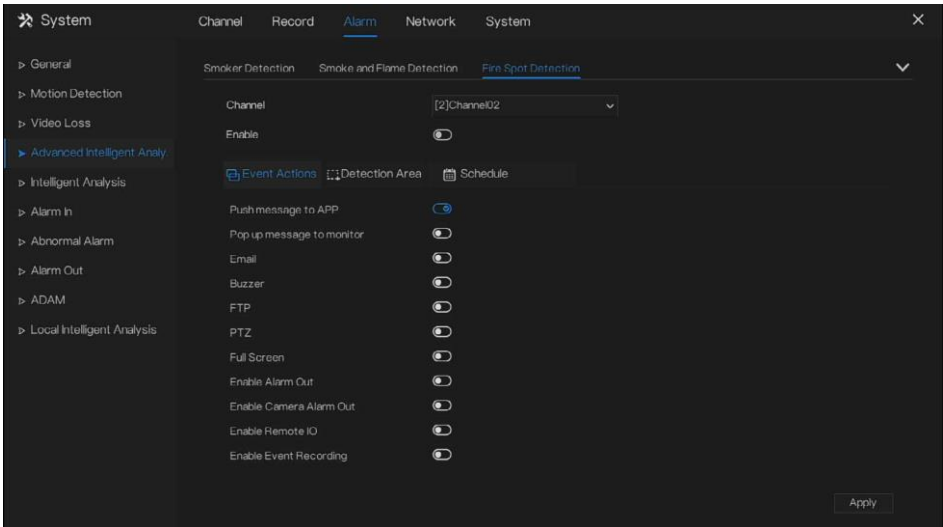

Parameter	Description	Setting
Channel	Choose thermal image camera from the drop-down list.	[How to set] Choose from the drop-down list
Enable	At thermal channel, Enable the button to enable the alarm.	[How to set] Choose from the drop-down list

Parameter	Description	Setting
Linkage action	Push message to App, Pop up message to monitor, Email, Buzzer, FTP, PTZ, Full screen, Enable alarm out, Enable Camera Alarm out, Enable Remote IO, Enable Event Recording.	[How to set] Click button to enable. [Default value] OFF
Sensitivity	The sensitivity of detecting smoker, when the value is high, the alarm can be triggered easily, but the accuracy will be lower.	[How to set] Choose from the drop-down list. [Default value] 5
Audio detection alarm	Enable, when happen the alarm, it will be play audio to alarm. Choose the sound alarm file (set at the “ Configuration > Alarm > Sound Alarm Output ”).	[How to set] Click to enable Audio Detection Alarm [Default value] OFF
Flashlight alarm	Enable, when it is triggered alarm, it flashes the light. But when users set the display mode to Mode 5 at “ Configuration > Thermal > Led Control Param ” interface, the light will be always on for 15s, not flash when it is alarm.	[How to set] Click to enable Flashlight Alarm. [Default value] OFF
Video Stream Draw Line	Enable the button to enable Video Stream Draw Line, the setting area frame will show on live video.	[How to set] Click to enable Video Stream Draw Line. [Default value] OFF

Figure 7-48 Fire Spot Detection – Detection Area

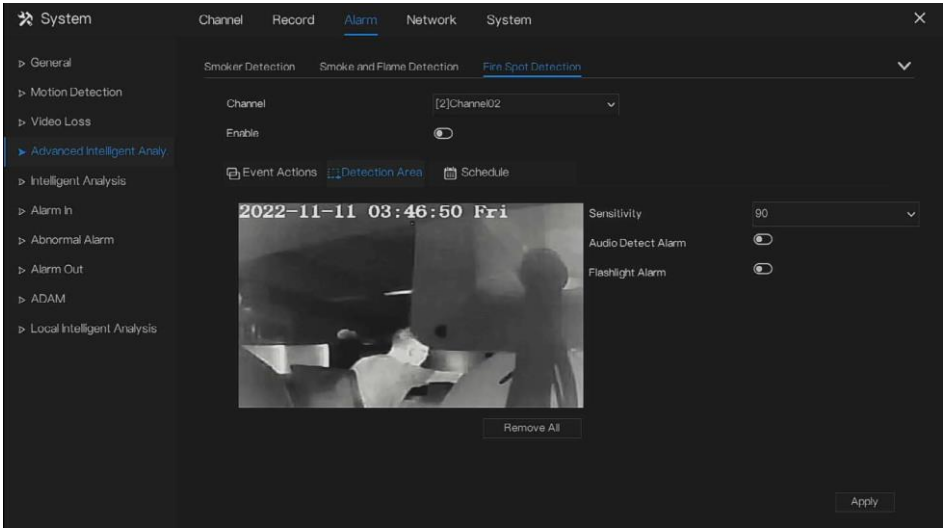
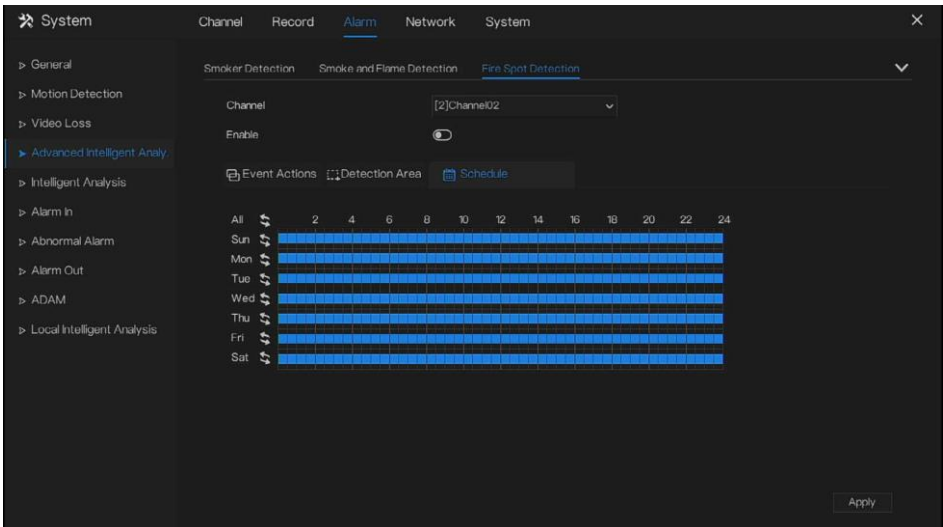



Figure 7-49 Fire Spot Detection – Schedule



Method 1: Click left mouse button to select any time point within 0:00-24:00 from Monday to Sunday.

Method 2: Hold down the left mouse button, drag and release mouse to select the deployment time within 0:00-24:00 from Monday to Sunday.

Method 3: Click  in the deployment time page to select the whole day or whole week.

NOTE

- When you select time by dragging the cursor, the cursor cannot be moved out of the time area. Otherwise, no time can be selected.

Deleting deployment time: Click  again or inverse selection to delete the selected deployment time.

7.3.5 Intelligent Analysis (Only for Some Models)

NOTE

The channel camera can set the intelligent analysis which are depended on the performance of cameras.

Operation Description

Step 1 Click **Intelligent Analysis** in the main menu or menu of the alarm management screen and choose **Intelligent Analysis** to access intelligent analysis screen, as shown in Figure 7-50.

Figure 7-50 Intelligent Analysis screen

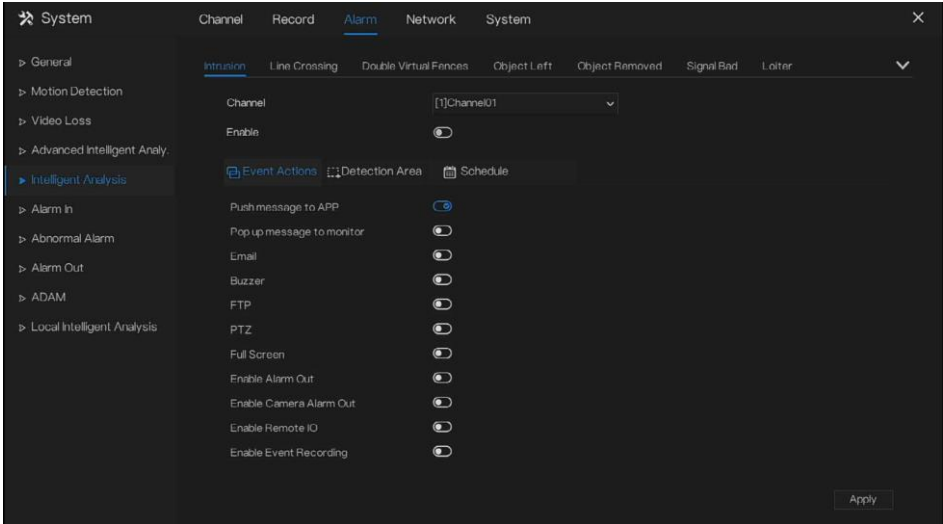

Step 2 Select one action to set the alarm.(Intrusion, Line crossing, Single virtual fence, Double virtual fences, Object left, Object removed, Signal bad, Loiter, Multi loiter, Abnormal speed, Converse, Illegal parking, Personnel count, Fence, Enter area, Leave area, Advanced).

Step 3 Select a channel from the drop-down list of channel.

Step 4 Click  to enable intelligent analysis alarm.

Step 5 Enable the event actions include: push message to App, pop up message to monitor, send Email, buzzer, FTP, PTZ, full screen, alarm out, camera alarm out, enable remote IO, event recording and so on.

Step 6 Click Schedule page to access the schedule screen.

Step 7 For details, please see *Figure 7-23* Step 5 Set the record schedule.



Step 8 Click  and select a channel, then click  to apply the parameter settings to cameras in selected channels, click  to save video loss settings.

Figure 7-51 Personnel count

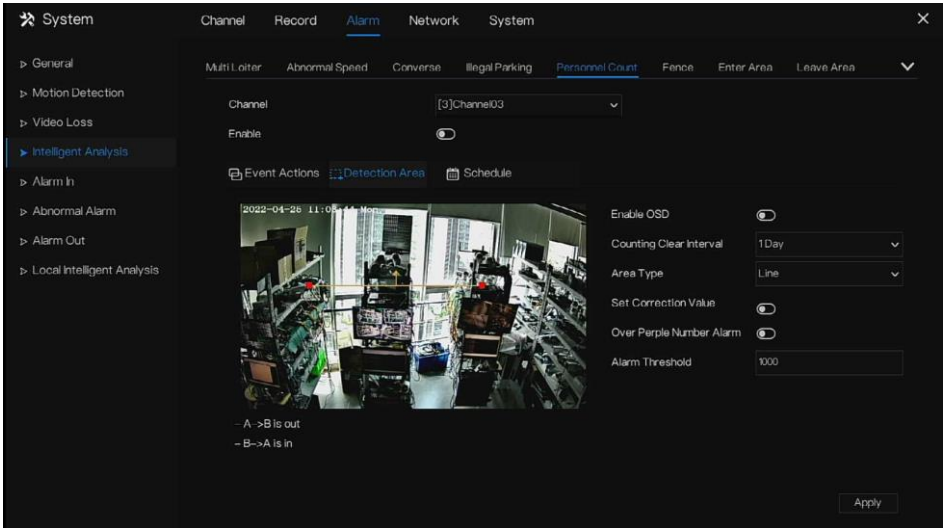

Table 7-10 Personnel count parameters

Parameter	Description	Setting
Enable	Click the button to enable personnel count.	[How to set] Click Enable to enable. [Default value] OFF
OSD enable	Enable, the statistical data of personnel count will show on OSD	[How to set] Click Enable to enable. [Default value] OFF
Counting clear interval	There are five modes can be chosen, such as 10 min, half-hour, 1 hour, 12-hour, 1 day.	[Setting method] Choose from drop-down list [Default value] 7
Area type	The area to distinguish entry and exit.	[Default value] Line

----End

Fence:

It is only available for fence AI multi-object cameras. When a person or car is found in detection area, it will alarm.

Users can choose several event actions to alarm.

Figure 7-52 Fence

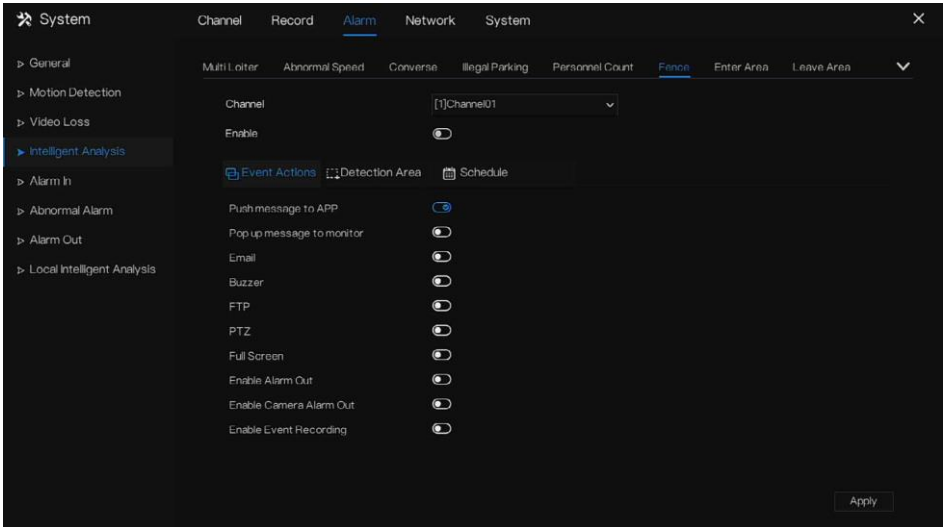
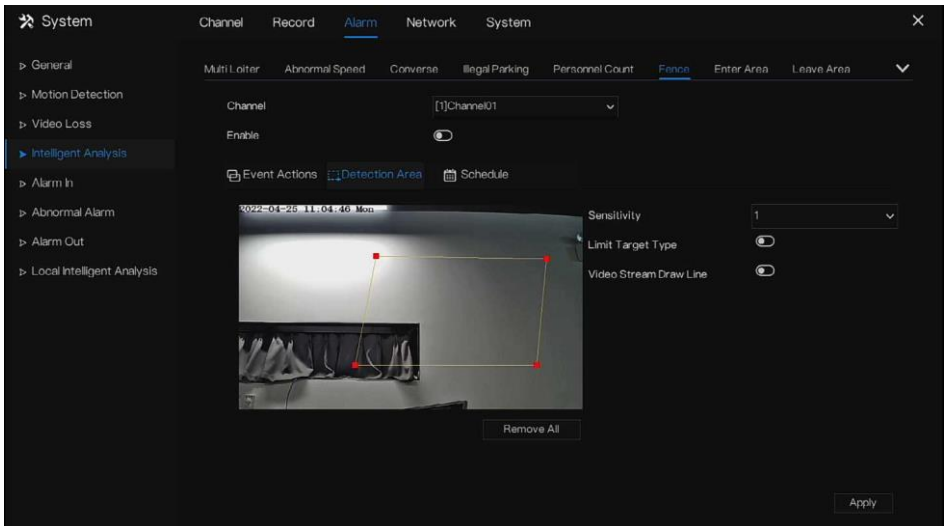

Figure 7-53 Fence detection area



Enable limit target type, choose the type(person or car, person, car).

Enable video stream draw line, when detects the car or person, it will show the blue frame to mark the target.

Use the mouse to draw the detection area, users can draw several areas depending on the real condition.

----End

7.3.6 Alarm In

NOTE

This function requires access to a camera that supports external alarm in.

There are two types alarm in, one is the NVR's alarm in, another is the camera channel's alarm in.

Operation Description

Click **Alarm in** in the main menu or menu of the alarm management screen and choose **Alarm in** to access the alarm in screen, as shown in Figure 7-54.

Figure 7-54 Alarm in screen

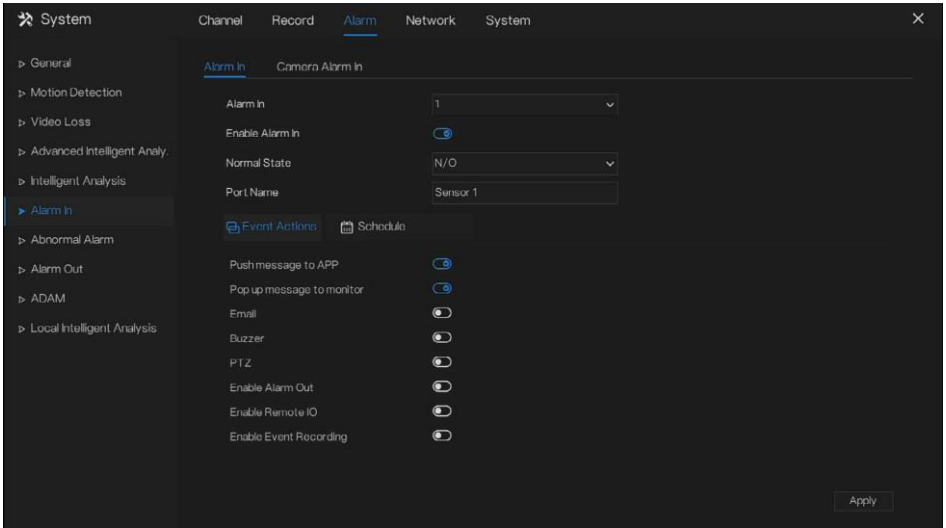
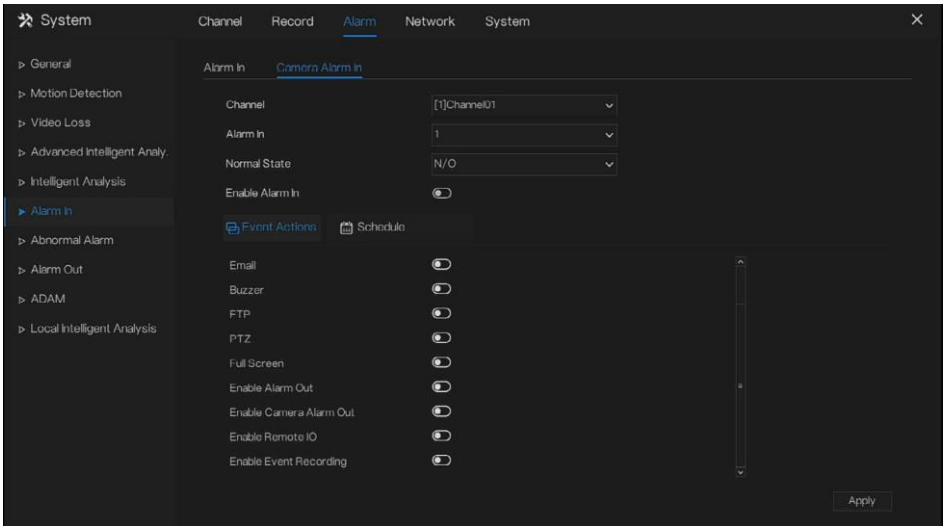



Figure 7-55 Camera alarm in



Operation Steps

Step 1 Select a channel in **alarm in**.

Step 2 Click  to enable or disable the functions.

Step 3 Select **Alarm type** from the drop-down list.

**NOTE**

NC: Normal close the alarm

NO: Normal open the alarm

Step 4 Set **name**.

Step 5 Enable the event actions include: push message to App, pop up message to monitor, send Email, buzzer, FTP, PTZ, full screen, alarm out, camera alarm out, enable remote IO, event recording and so on.

Step 6 Click **Schedule** page to access the schedule screen. For details, please see 7.2.1 Record Schedule Figure 7-23Step 5 Set the record schedule.

Step 7 Click  to save settings of **Alarm in**.

----End

7.3.7 Abnormal Alarm

Abnormal alarm includes disk alarm, IP conflict and network disconnected.

Operation Description

Step 1 Click **Abnormal Alarm** in the main menu or menu of the alarm management screen and choose **Abnormal Alarm** to access the abnormal alarm screen, as shown in Figure 7-56.

Figure 7-56 Abnormal alarm screen

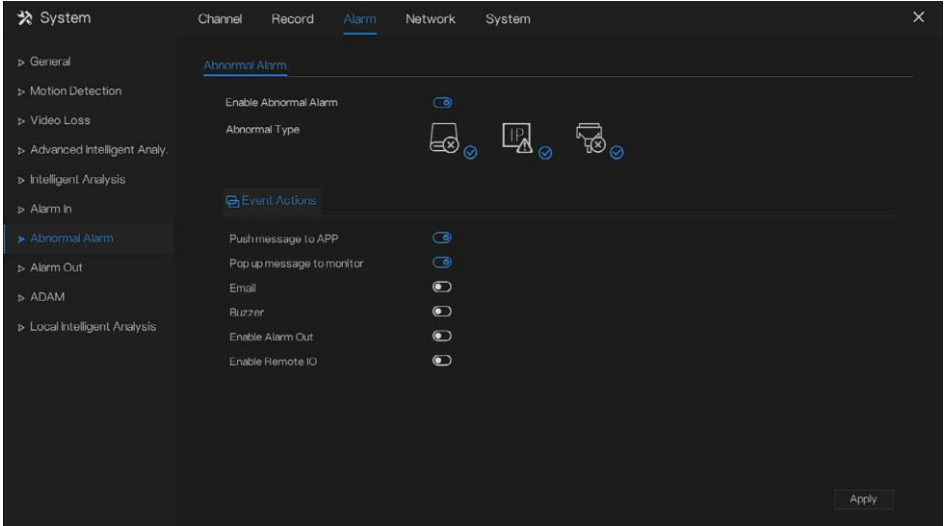

Step 2 Tick the abnormal actions.

Step 3 Enable the event actions include: push message to App, pop up message to monitor, send Email, buzzer, alarm out, enable remote IO and so on.

Step 4 Click **Apply** to save abnormal alarm settings.

----End

7.3.8 Alarm Out

7.3.8.1 Alarm Out

Choose one output ID as the output interface.

Figure 7-57 Alarm out

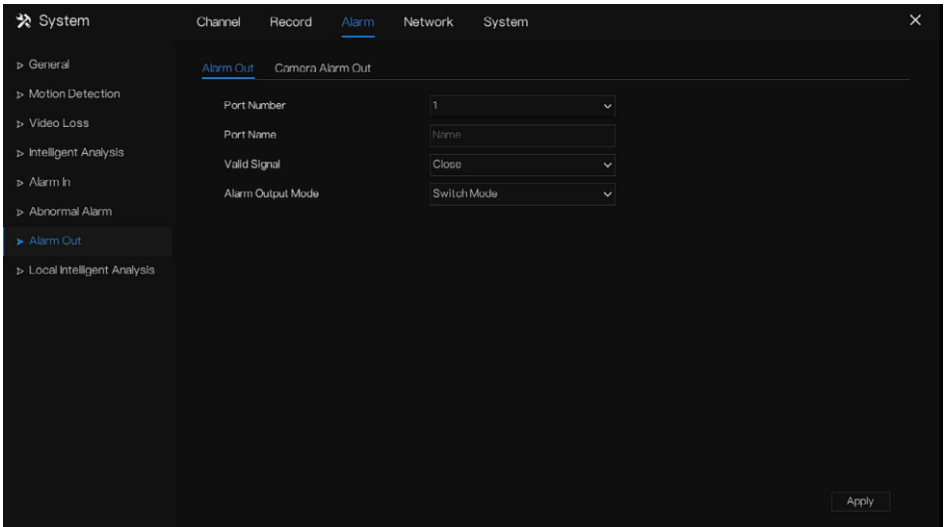

----End

7.3.8.2 Camera Alarm out

 **NOTE**

This function requires access to a camera that connected to an external alarm out device.

Figure 7-58 Camera alarm out

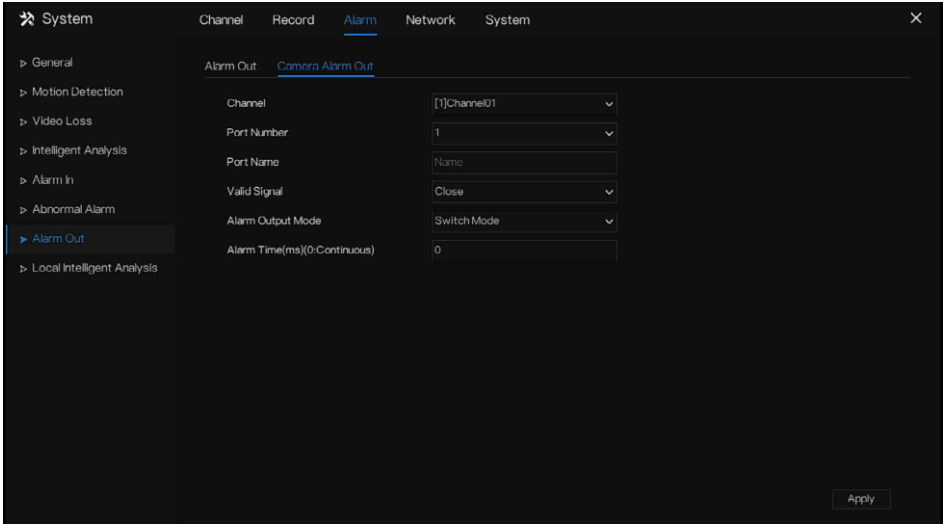

Table 7-11 Camera alarm out

Parameter	Description	Setting
Alarm Output	ID of the alarm output channel. NOTE The number of alarm output channels depends on the device model.	[Setting method] Select a value from the drop-down list box. [Default value] 1
Name	Alarm output channel name.	[Value range] 0 to 32 bytes
Valid Signal	The options are as follows: Close: An alarm is generated when an external alarm signal is received. Open: An alarm is generated when no external alarm signal is received.	[Setting method] Select a value from the drop-down list box. [Default value] Close

Parameter	Description	Setting
Alarm Output Mode	<p>When the device receives I/O alarm signals, it will send the alarm information to an external alarm device in the mode specified by this parameter. The options include the switch mode and pulse mode.</p> <p>NOTE</p> <p style="padding-left: 40px;">If the switch mode is used, the alarm frequency of the device must be the same as that of the external alarm device.</p> <p style="padding-left: 40px;">If the pulse mode is used, the alarm frequency of the external alarm device can be configured.</p>	<p>[Setting method] Select a value from the drop-down list box. [Default value] Switch Mode</p>
Alarm Time(ms) (0: Continuous)	<p>Alarm output duration. The value 0 indicates that the alarm remains continuous valid.</p>	<p>[Setting method] Enter a value manually. [Default value] 0 [Value range] 0 to 86400 seconds</p>
Manual Control	Control the alarm output.	N/A

----End

7.3.9 ADAM (Only for Some Models)

By adding some ADAM data acquisition modules which is in the same network segment as NVR, ADAM outputs alarm information remotely. The output terminal of ADAM terminal shall be connected to relevant alarms in advanced, such as alarm lights or alarms.

NVR related alarm management starts remote ID (remote ID refers to the number of ADAM data acquisition modules that can be accessed, and the maximum number of channels that can be accessed is consistent with NVR channels), and the port number is that the alarm device accesses to the ADAM data acquisition modules.

Figure 7-59 ADAM

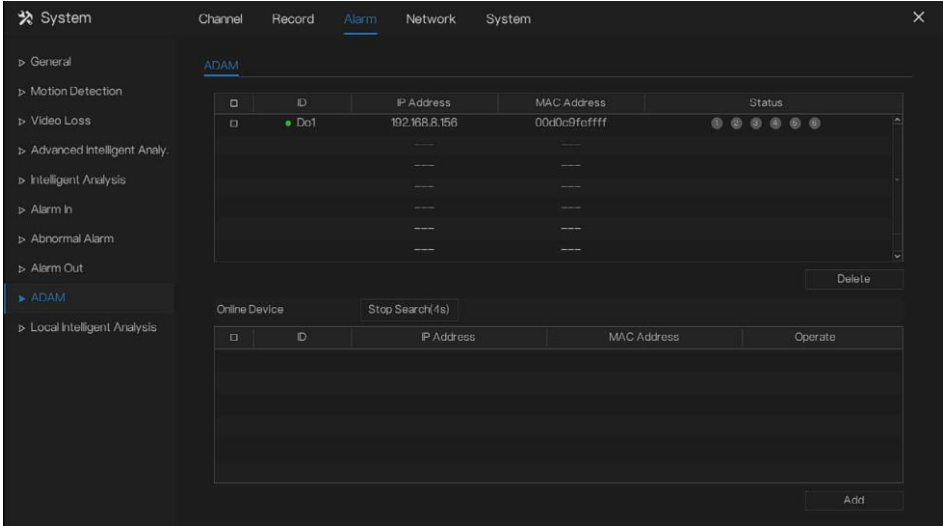

Click Search to search the on-line ADAM.

Tick the ID of the searched ADAM, click Add to add to list. The status is showing on the list.

The ID is corresponding to the remote channel number of the remote IO.

The alarm device is accessed to ADAM ID is corresponded with the port number.

7.3.10 Local Intelligent Analysis (Only for Some Models)

7.3.10.1 General

At “Alarm > Local Intelligent Analysis > General” interface, enable the local intelligent analysis to set the local intrusion, as shown in Figure 7-60.

Figure 7-60 Local intelligent analysis – General

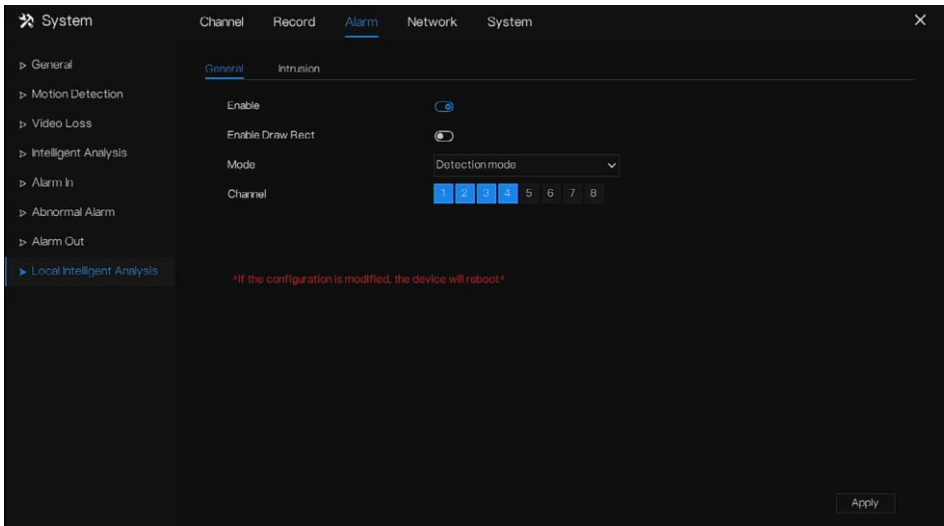

Enable the alarm function.

Enable Draw Rectangle, the detection rectangle will be shown on the live video of intrusion.

Choose the channels, support up to 4 channels.

Enable or disable the intrusion, modify the channels, click the “Apply” and the device will be rebooted.

7.3.10.2 Intrusion

At “Alarm > Local Intelligent Analysis > Intrusion” interface to set the parameter of local intrusion.

The “Intrusion” refers to that an alarm is generated when the targets of specified types (such as person, car, and both person and car) enter the detection area.

Figure 7-61 Intrusion

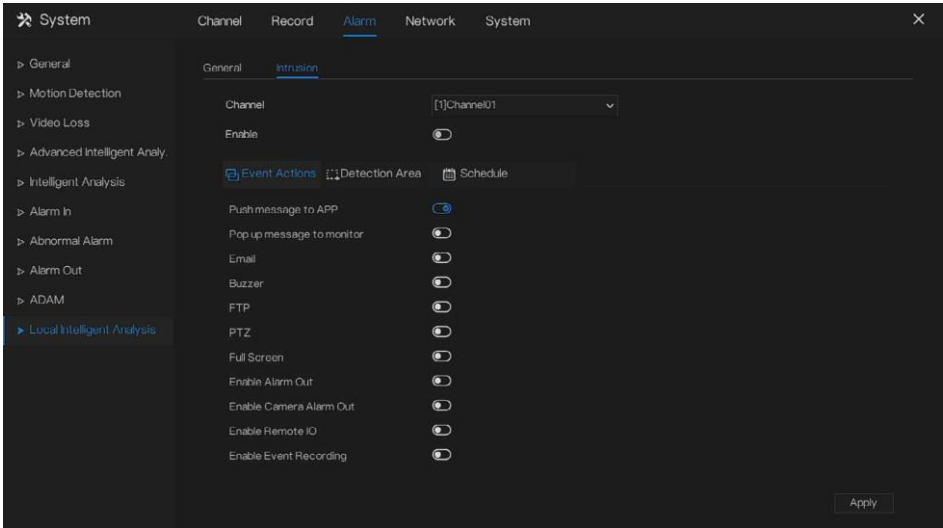

Event action:

Choose the channel to enable the intrusion, enable the event actions (such as push message to App, Pop up message to monitor, Email, Buzzer, FTP, PTZ, Full screen, Alarm out, Camera alarm out, enable remote IO, Event recording, and so on). Click “Apply” to save the settings.

Figure 7-62 Detection area

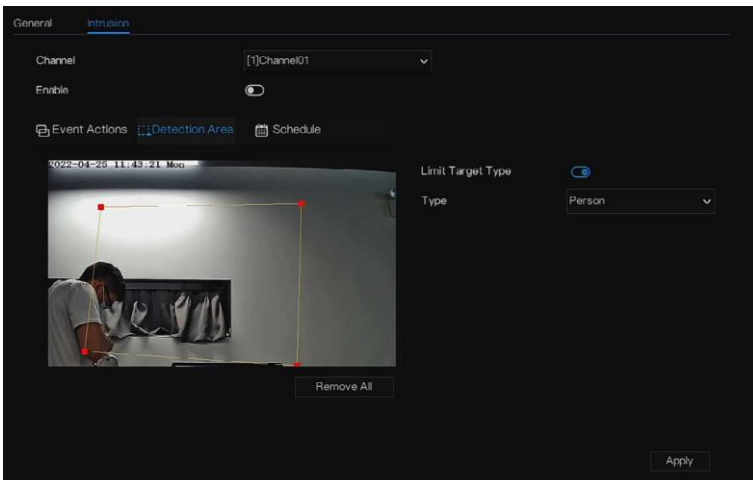

Detection area:

Move the cursor to the drawing interface and click to generate a point, move the cursor to draw a line, and then click to generate another point. This is how a line is generated. In this way, continue to draw lines to form any shape, and right-click to finish line drawing.

 **NOTE**

A drawn line cannot cross another one, or the line drawing fails.

Any shape with 8 sides at most can be drawn.

The quantity of detection areas is not limited yet and will be described in future when a limit is applied.

Choose Limit target from the drop-down list, person/ person or car / car.

Figure 7-63 Set schedule



Set schedule:

Method 1: Click left mouse button to select any time point within 0:00-24:00 from Monday to Sunday as shown in Figure 7-63.

Method 2: Hold down the left mouse button, drag and release mouse to select the schedule within 0:00 -24:00 from Monday to Sunday.

 **NOTE**

When you select time by dragging the cursor, the cursor cannot be moved out of the time area.

Otherwise, no time can be selected.

Method 3: Click  in the schedule page to select the whole day or whole week.

Deleting schedule: Click  again or inverse selection to delete the selected schedule.

----End

7.4 Network Management

Set the **Network Parameter, 802.1X, DDNS, E-mail, Port Mapping, P2P, IP Filter, SNMP 3G/4G** and **PPPOE, Network Traffic** in the network management screen.

Operation Description

Step 1 Click **Network** in the main menu (or click the network page of any function screen in the main menu) to access the network management screen, as shown in Figure 7-64.

Figure 7-64 Network management screen

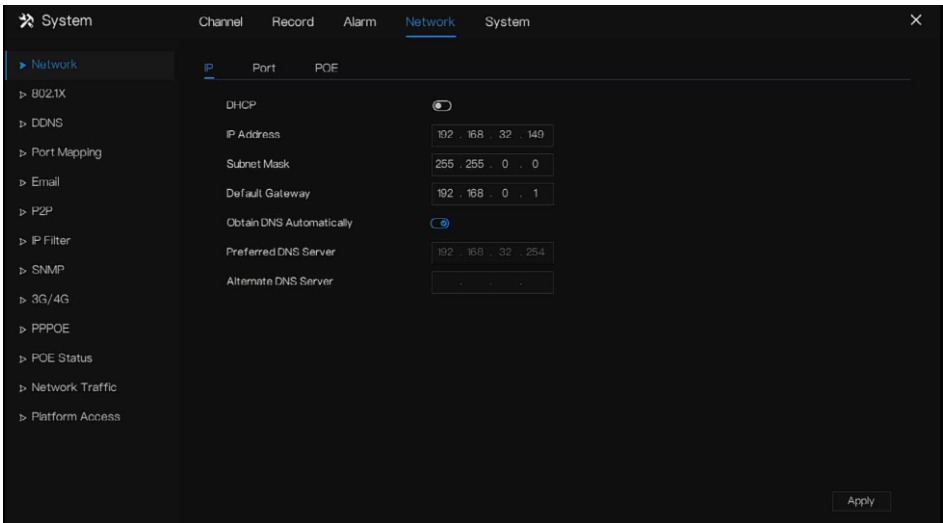

7.4.1 Network

Set **DHCP** and **DNS** manually or automatically.

7.4.1.1 IP

Operation Steps

Step 1 Click  next to **DHCP** to enable or disable the function of automatically getting an IP address. The function is disabled by default.

Step 2 If the function is disabled, click input boxes next to **IP**, **Subnet mask**, and **Gateway** to set the parameters as required.

Step 3 Click  next to **Obtain DNS Automatically** to enable or disable the function of automatically getting a DNS address. The function is enabled by default.

Step 4 If the function is disabled, click input boxes next to **DNS 1(default 192.168.0.1)** and **DNS 2(default 8.8.8.8)**, delete original address, and enter a new address.

Step 5 Click  to save IP settings.

----End

7.4.1.2 Port

Operation Steps

Step 1 Click **Port** page to access the port setting screen, as shown in Figure 7-65.

Figure 7-65 Port setting screen

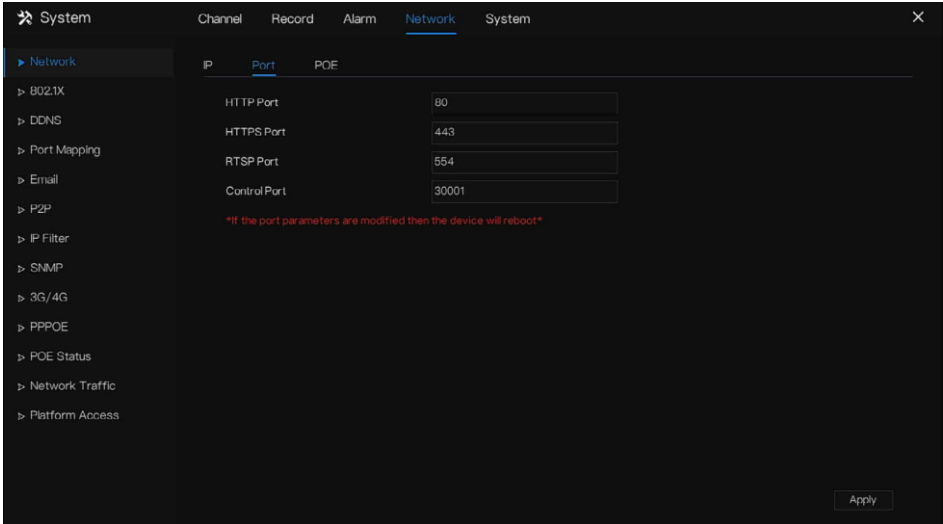

Step 2 Set the HTTP port, HTTPS port, RTSP port and Control port.

Step 3 Click **Apply** to save port settings.

----End

7.4.1.3 IPv4CCTV (Only for Some Models)

The no POE device has two LANs, LAN1 and LAN2.

Operation Steps

Step 1 Click **Ipv4 CCTV** page to access the LAN2 setting screen, as shown in Figure 7-66.

Figure 7-66 IPv4 CCTV

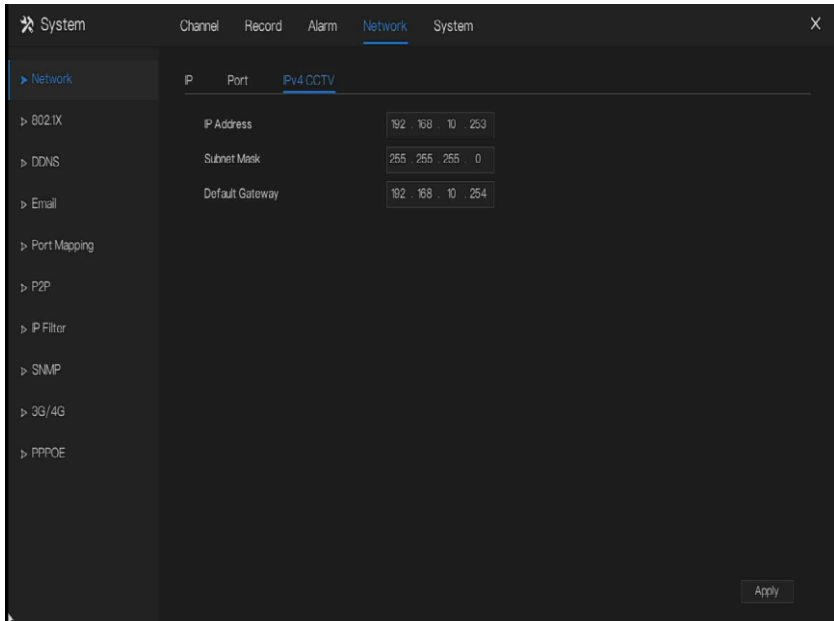

Step 2 Input the IP address, subnet mask, default gateway.

Step 3 Click  to save the settings.

NOTE

LAN1 and LAN2 can be connected to different network, so that NVR can add more cameras. LAN1 usually is connected to the external network, it is default gateway. LAN2 connect to internal network.

----End

7.4.1.4 POE (Only for Some Models)

Operation Steps

Step 1 Click **POE** page to access the POE setting screen, as shown in Figure 7-67.

Figure 7-67 POE screen

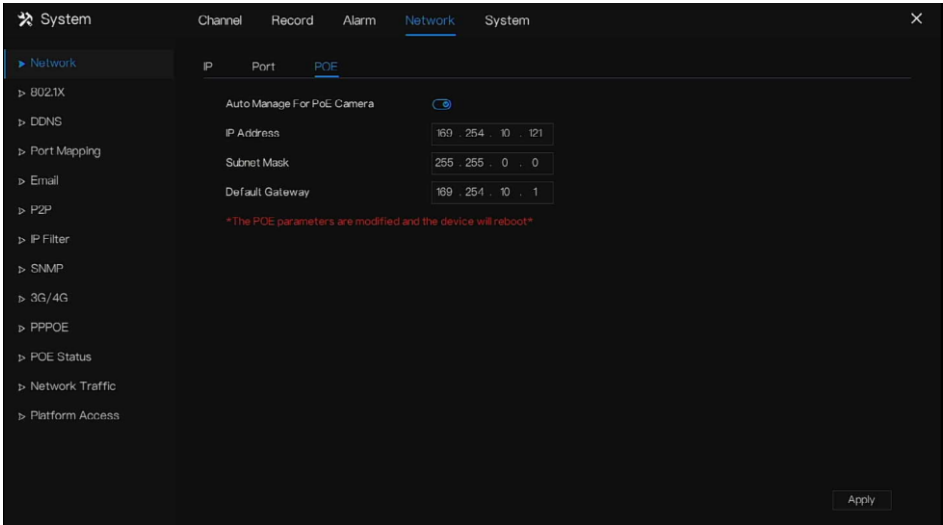

Step 2 The NVR will deploy IP addresses to the cameras connected to POE immediately.

Step 3 Click **Apply** to set POE camera IP address successfully.

----End

7.4.1.5 WiFi Parameter (Only for Some Models)

Operation Steps

Step 1 Click **WiFi Parameter** page to access the WiFi Parameter setting screen, as shown in Figure 7-67.

Figure 7-68 WiFi Parameter

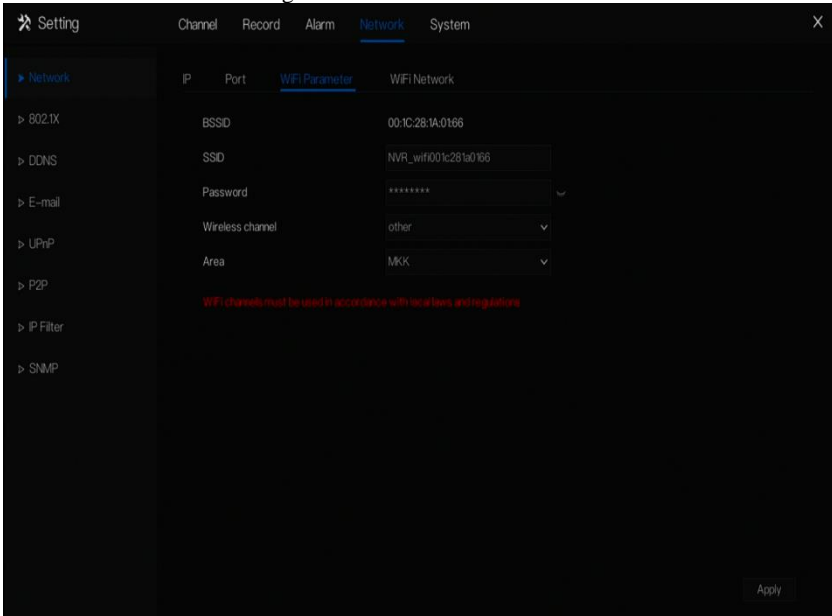

Step 2 Set the parameters of WiFi.

Step 3 Click **Apply** to set POE camera IP address successfully.



NOTE

BSSID, default value of the device, cannot be changed.

SSID, the name can be changed to facilitate customer search.

WiFi channel; 1-13 channels, plus the other channel, can be changed according to network blocking conditions to avoid interference.

The area can be selected according to the country where it is located, MKK, ETS11, ETS12, FCC.

----End

7.4.1.6 WiFi Network (Only for Some Models)

Operation Steps

Step 1 Click **WiFi Parameter** page to access the WiFi Parameter setting screen, as shown in Figure 7-67.

Figure 7-69 WiFi network

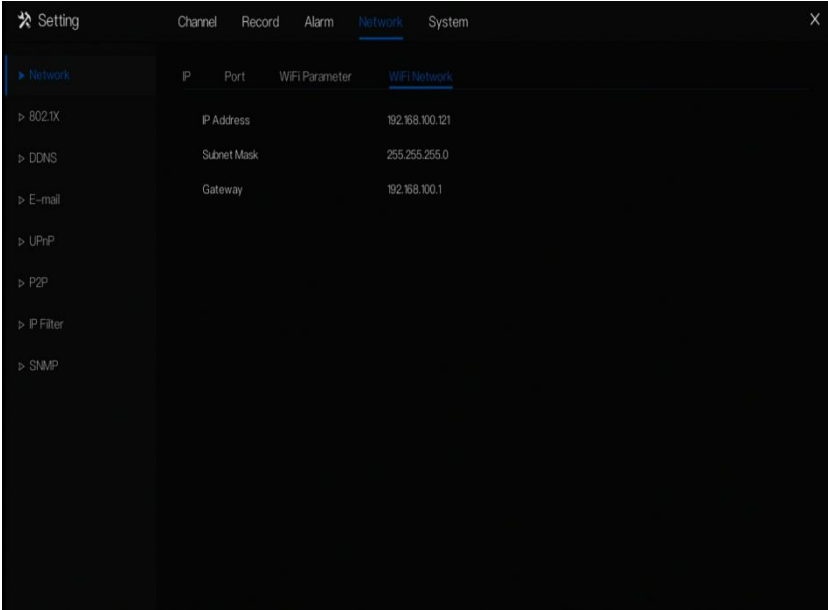

----End

7.4.2 802.1 X

Operation Steps



Step 1 Click  next to **802.1 X** to enable or disable the function .The default is disabled.

Figure 7-70 802.1 X

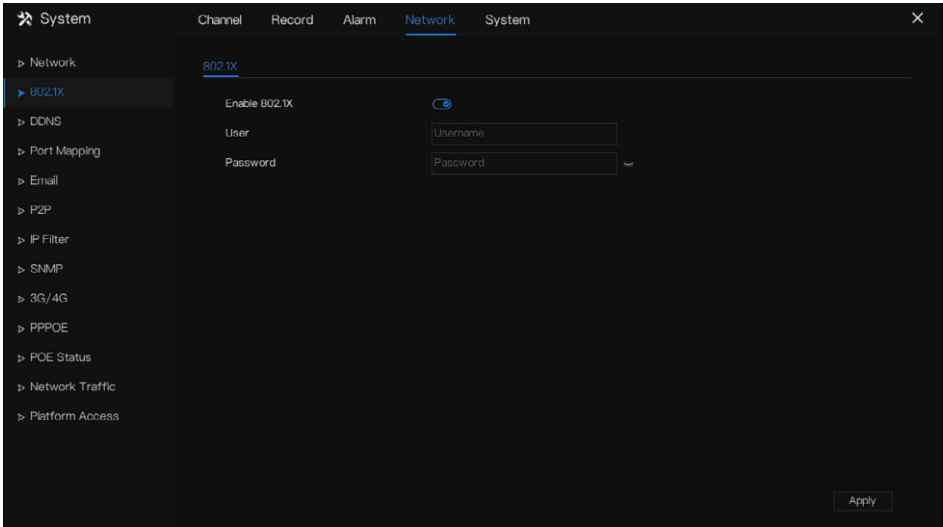

Step 2 Input the user and password of 802.1X, the account is created by user.

Step 3 Click  to save the settings. The visitor to view the NVR need to input account to certify.

----End

7.4.3 DDNS

Please make sure connect the specified camera to the Internet, and obtain the user name and password for logging into the dynamic domain name system (DDNS) from the server.

Operation Steps

Step 1 Click **DDNS** in the main menu or menu of the network management screen and choose **DDNS** to access the DDNS screen.

Step 2 Click  next to **Enable** to enable the DDNS function. It is disabled by default, as shown in Figure 7-71.

Figure 7-71 DDNS setting screen



Step 3 Select a required value from the protocol drop-down list.

Step 4 Set domain name, input user and password.

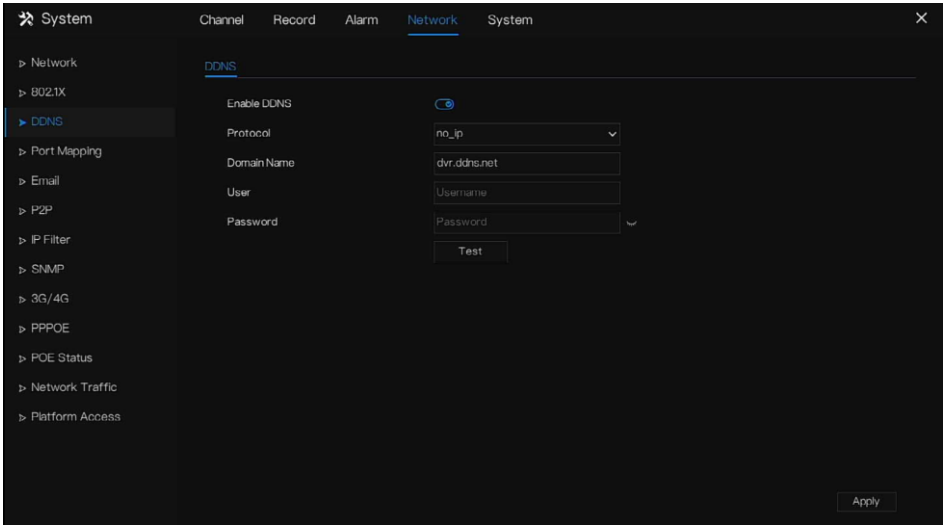
Step 5 Click **Test** to check the domain name.

Step 6 Click **Apply** to save DDNS network settings

 **NOTE**

An external network can access the NVR via an address that is set in the DDNS settings.

----End

7.4.4 Port Mapping

7.4.4.1 Port Mapping

Operation Steps

Step 1 Click **Port Mapping** in the main menu or menu of the network management screen and choose **Port Mapping** to access the port mapping screen, as shown in Figure 7-72.

Figure 7-72 Port mapping setting screen

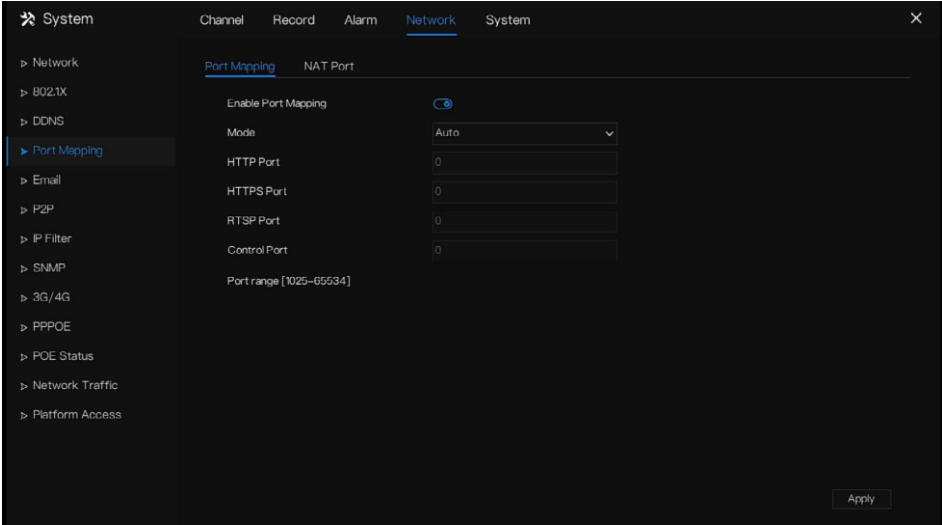

Step 2 Select UPnP enable type.

Step 3 Manual UPnP: input http port, data port and client port manually.

Step 4 Auto UPnP: device obtain the port automatically.

Step 5 Click  to save settings.

----End

7.4.4.2 NAT Port

NAT Port (Network Address Translation). Access the NVR channels through the NAT port. Users can set the start port, and it will generate the end port automatically. We will view the NAT port

when we access the channel through clicking  icon at Web interface.

Figure 7-73 NAT port



----End

7.4.5 Email

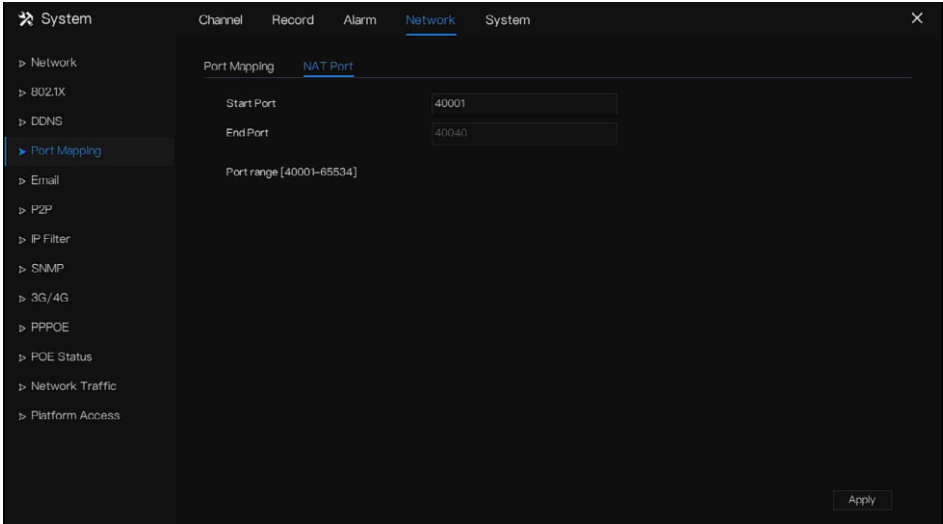
If the simple mail transfer protocol (SMTP) function is enabled, the device automatically sends alarm information to specified email addresses when an alarm is generated. Two mailboxes can be set as receivers.

Operation Steps

Step 1 Click **E-mail** in the main menu or menu of the network management screen and choose **E-mail** to access the E-mail screen, as shown in Figure 7-74.

Figure 7-74 E-mail setting screen

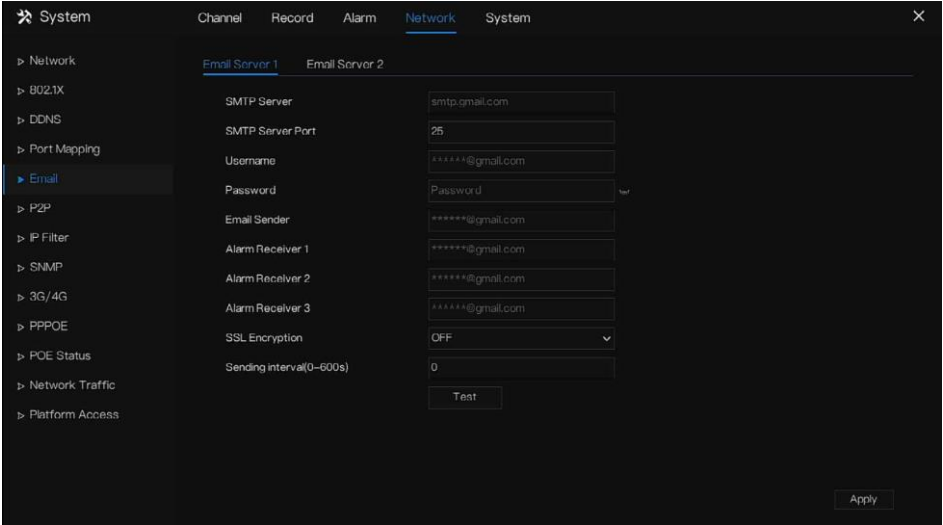
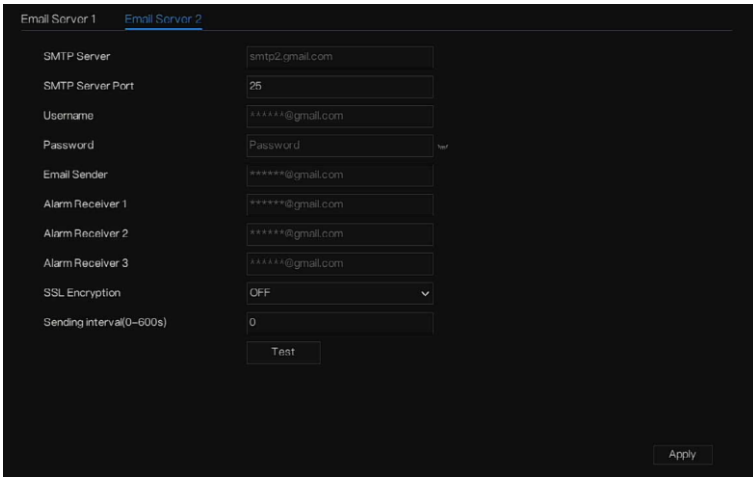

Figure 7-75 E-mail server 2



Step 2 Set SMTP server address and SMTP server port manually.

Step 3 Input E-mail sender, user name and password manually.

Step 4 Set E-mail for receiving alarm. the message “**Mail has been sent, please check**” is displaying. Open the mail, if the verification code is received, that shows the E-mail is set successfully.

Step 5 Set E-mail for retrieve the password. the message “Mail has been sent, please check” is displaying. Open the mail, if the verification code is received, E-mail is set successfully.

Step 6 Set SSL encryption for encrypting mail or not, set sending interval.

Step 7 Click  to save settings.

----End

7.4.6 P2P

Show the UUID code and set the P2P status of the device.

Operation Steps

Step 1 Click **P2P** in the main menu or menu of the network management screen and choose **P2P** to access the P2P screen, as shown in Figure 7-76.

Figure 7-76 P2P screen

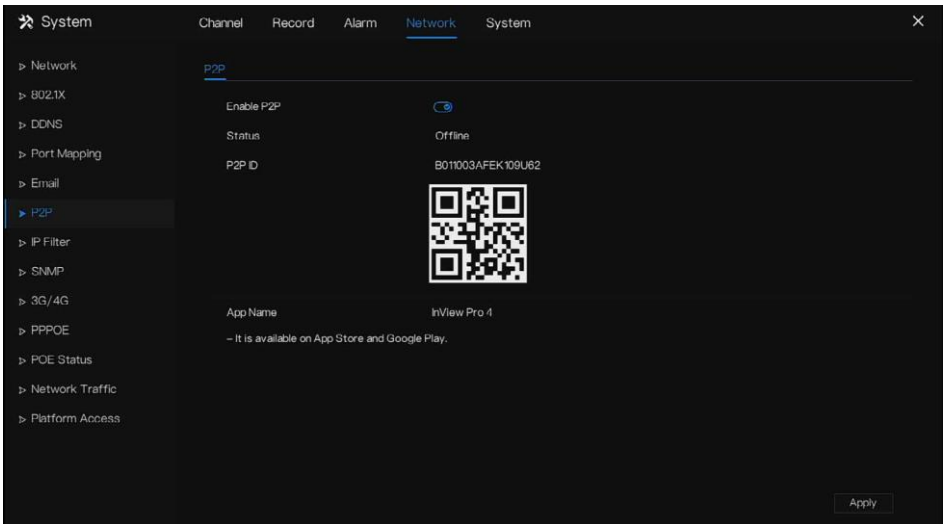

Step 2 Click  to enable the P2P function.

Step 3 Click  to save P2P network settings or click **Cancel** to cancel settings.

Step 4 After the **Inview Pro4** is installed in mobile phone, run the APP and scan the QR to add and access the NVR when the device is online.

----End

7.4.7 IP Filter

Set the IP address in specified network segment to allow or prohibit access.

Operation Steps

Step 1 Click **IP Filter** in the main menu or menu of the network management screen and choose **IP Filter** to access the IP filter screen, as shown in Figure 7-77.

Figure 7-77 IP Filter setting screen

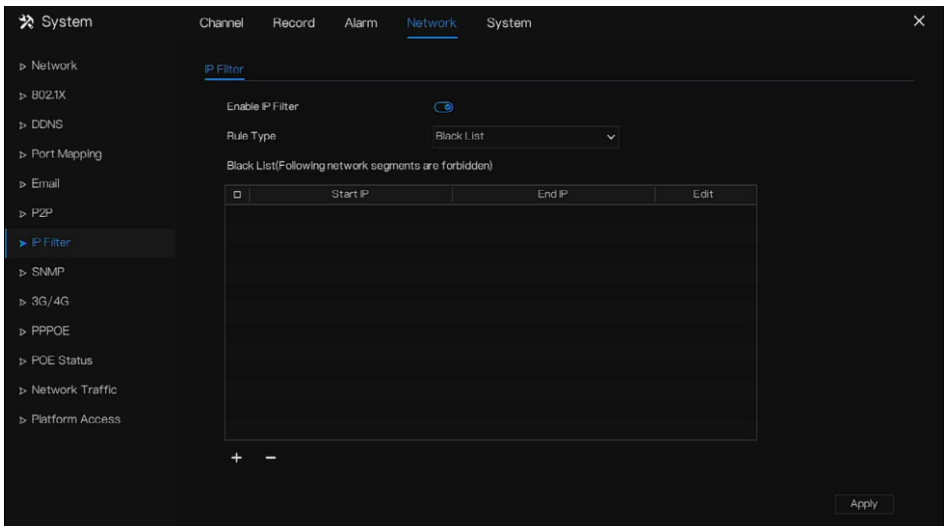

Step 2 Click  next to **IP Filter** to enable the function of IP Filter.

Step 3 Select black list or white list drop-down list.

Step 4 Click  to set black & white list IP segment screen is displaying, as show in Figure 7-

78.

Figure 7-78 IP Address Segment screen

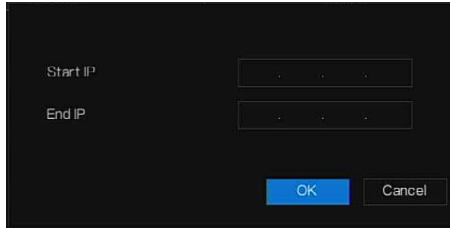

Step 5 Enter value manually for start IP address, end IP address.

Step 6 Click . The system saves the settings. The black and white lists IP segment listed in the black (white) list.

 **NOTE**

Black list: A list of IP addresses in specified network segment that are regarded as unacceptable or untrustworthy and should be excluded or avoided.

White list: a list of addresses in specified network segment considered to be acceptable or trustworthy.

Select a name in the list and click **Delete** to delete the name from the list.

Select a name in the list and click **Edit** to edit the name in the list.

Only one rule type is available, and the last rule type set is efficient.

----End

7.4.8 SNMP

There are three versions of simple network management protocols at interface.

Operation Steps

Step 1 Click **IP Filter** in the main menu or menu of the network management screen and choose **IP Filter** to access the IP filter screen, as shown in Figure 7-79.

Figure 7-79 SNMP settings screen

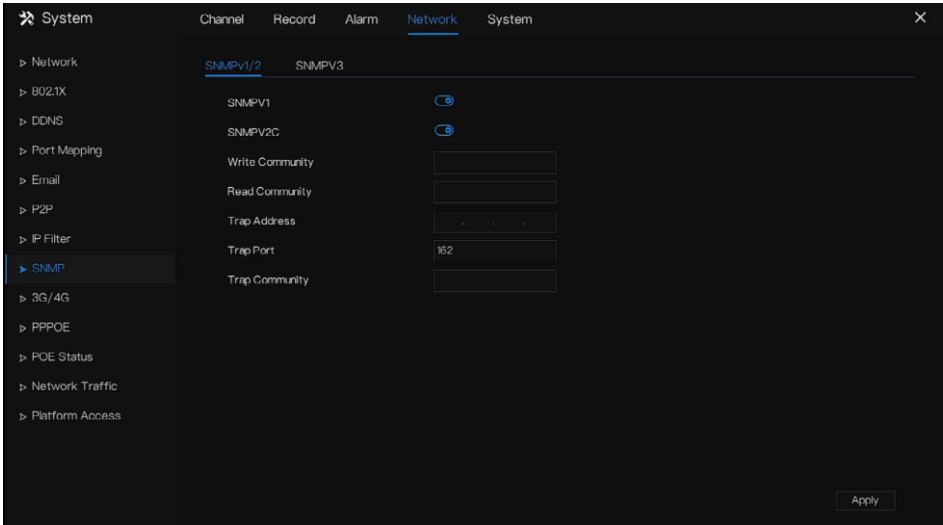



Step 2 Click  next to **SNMPV 1** to enable the function . The interface is shown as Figure 7-80.

Figure 7-80 SNMPV 1/2 interface

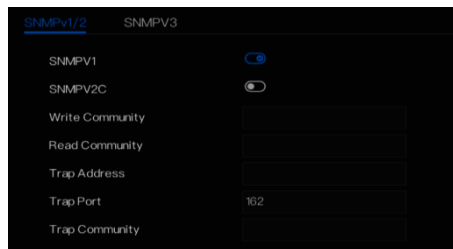

Step 3 Input the parameters of protocol.

Step 4 Click  to save settings or click  to cancel settings.

----End

7.4.9 3G/4G

Users can connect NVR to the data network using a modem.

Operation Steps

Step 1 Plug the modem to NVR, and enable the 3G/4G function, as shown in Figure 7-81.

Figure 7-81 3G/4G setting screen

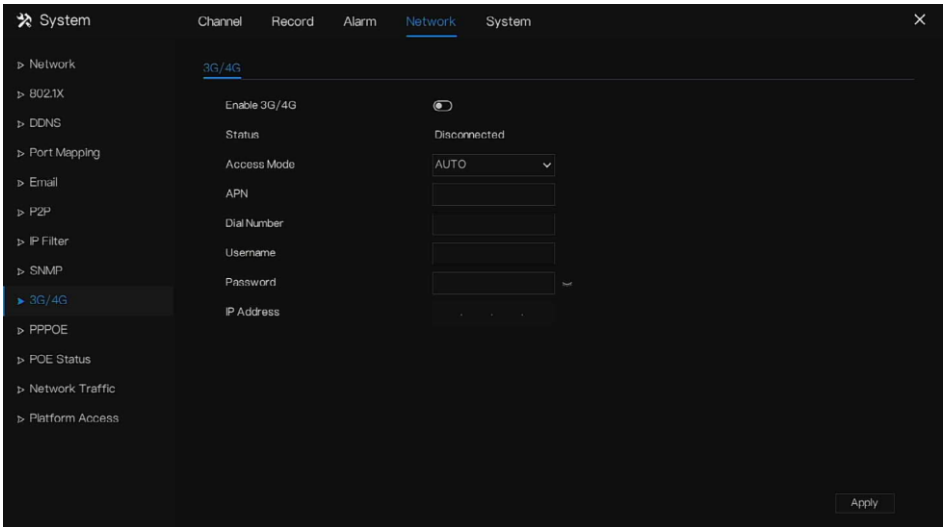

Step 2 If the connection is successful, set other parameters.

Step 3 Choose access mode, the default is AUTO. There are five modes can be chosen, such as AUTO, LTE, TD-SCDMA, WCDMA, GSM/GPRS.

Step 4 Input the APN, dial number, username, password, IP address. At auto mode, all these parameters can be obtained automatically.

Step 5 Click **Apply** to save settings.

 **NOTE**

Modify the access mode of 3G/4G (AUTO, LTE, TD-SCDMA, WCDMA, GSM/GPRS). If you cannot dial within 5 minutes, re-plug the modem.

Users are familiar with the relevant network (different service provider parameters are different) and modem information before manually switching to other modes, the recommended mode is **Auto**.

When using the 3G / 4G function, you need to manually close the PPPOE function. Only one function can be used at a time.

If the Internet access type is LTE (4G network), you do not need to dial the number, user name and password.

----End

7.4.10 PPPOE

PPPOE point to point protocol Ethernet, user use the PPPOE to access network immediately, as shown in Figure 7-82.

Figure 7-82 PPPOE

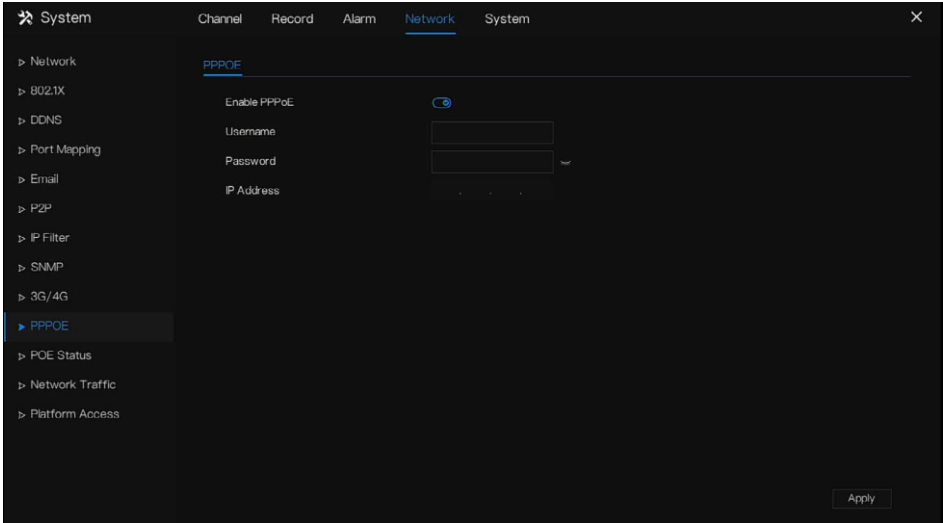

Step 1 Enable the PPPOE function.

Step 2 Input the username, password (provided by network operator).

Step 3 Click **Apply** to save settings, and the IP is obtained automatically.

Step 4 Users input the IP to access NVR web immediately.

----End

7.4.11 POE Status (Only for Some Models)

Users can view the status of POE intuitively, as shown in Figure 7-83.

Figure 7-83 POE status

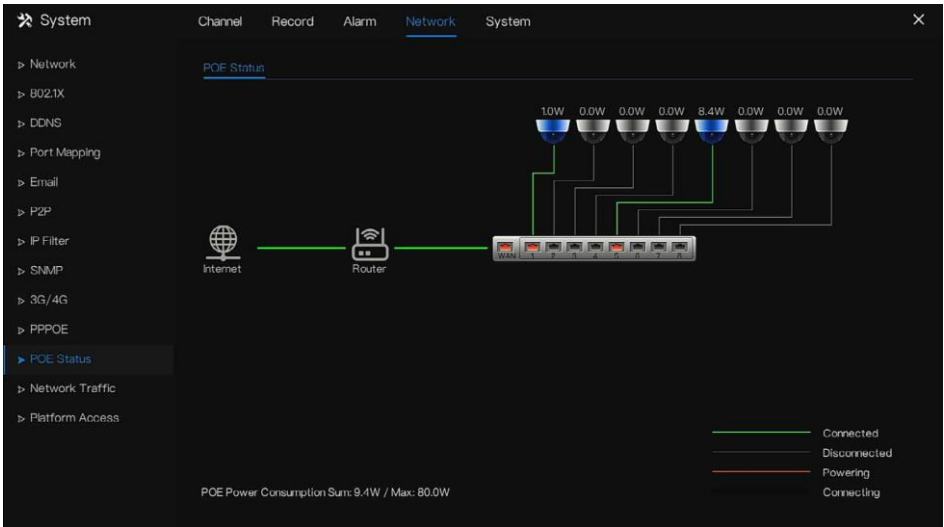

----End

7.4.12 Network Traffic

Users can view the network traffic immediately, as shown in Figure 7-84

Figure 7-84 Network traffic

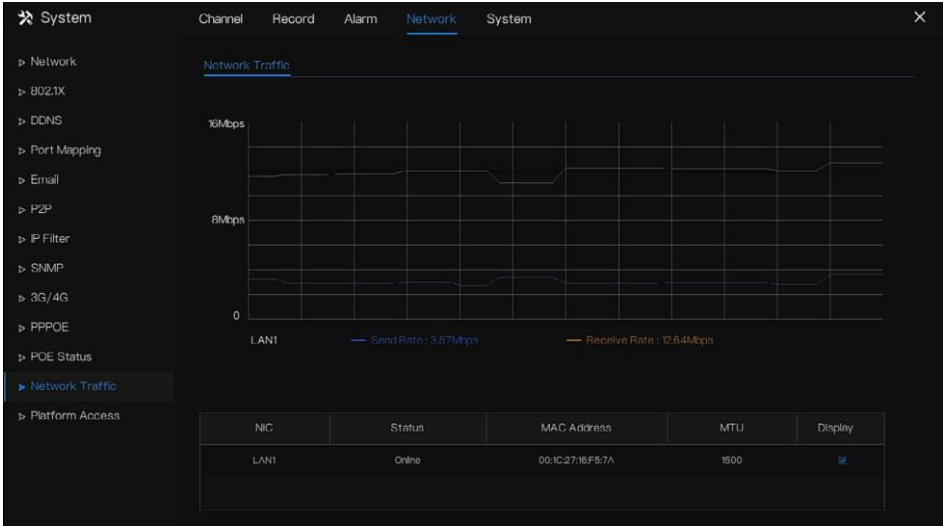

There are two rates, transmit rate and receive rate. The status of LAN(s) show on list.

----End

7.4.13 Platform Access

If the NVR and platform system are not at the same local network, ensure the NVR is connected to the same external server as the platform system. You should build a server for platform in advanced, platform's remote IP/Port and NVR are mapping port to external network.

Step 1 Choose **Configuration > Network Service > Platform Access**.

The **Platform Access** page is displayed, as shown in Figure 7-85

Figure 7-85 Platform Access page

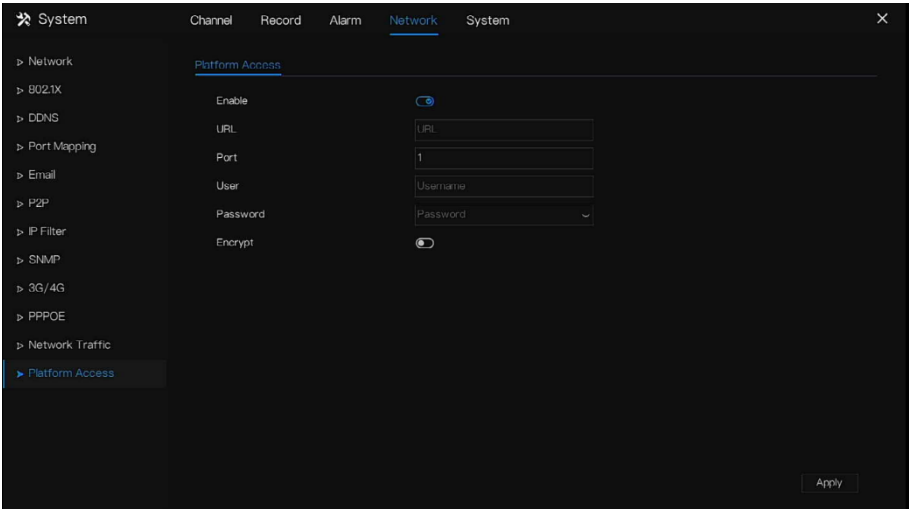

Step 2 Input the parameters. The URL and port are the platform server IP address and port

Step 3 The name and port are the platform’s login name and password.

Step 4 Add the NVR to platform, you should input the following information.

1: IP/ID/Domain name is Device ID of NVR.

Figure 7-86 IP/ID/Domain

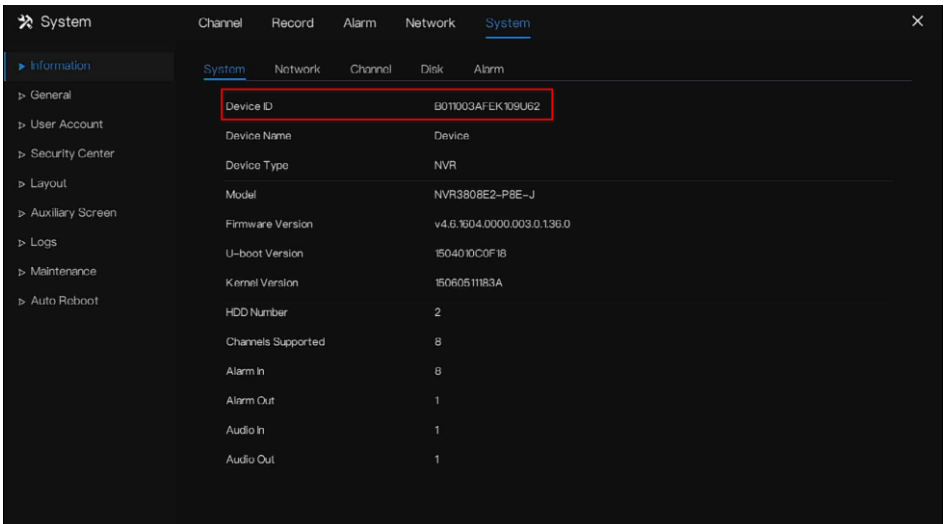

2: The connection mode should be chosen **Device active registration**.

Figure 7-87 Connect NVR to platform

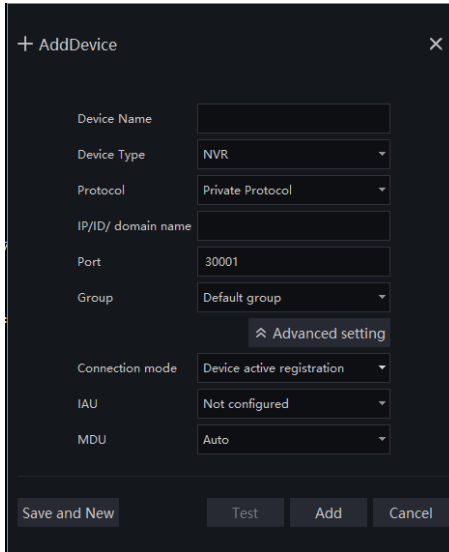

3: the CMU, MDU and IAU servers of platform should be mapped to the ports to external network in advanced.

Figure 7-88 URL address / port

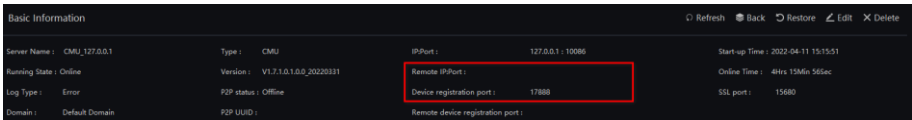

Step 5 If you want to encrypt the access, you can enable the Encrypt.

Step 6 Click **Apply**.

The message "Apply success!" is displayed, and the system saves the settings.

----**End**

7.5 System Management

View the device **Information** and set **General** information, **User Account**, **Security Center**, **Layout**, **Logs**, **Maintenance** and **Auto Reboot** for the system setting.

Operation Description

Click **System** in the main menu (or click the system page of any function screen in the main menu) to access the system setting screen, as shown in Figure 7-89.

Figure 7-89 System setting screen

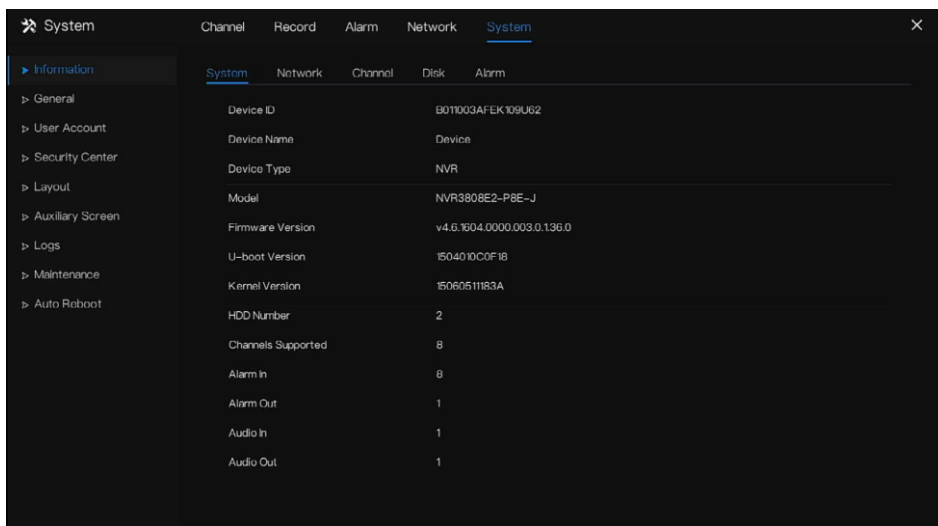

7.5.1 Information

View the device ID, device name, device type, model, firmware version, kernel version, face detection version, HDD volume, channel support, alarm in, and alarm out, audio in, audio out in **information** screen, as shown in Figure 7-90 .

Figure 7-90 Information-system interface

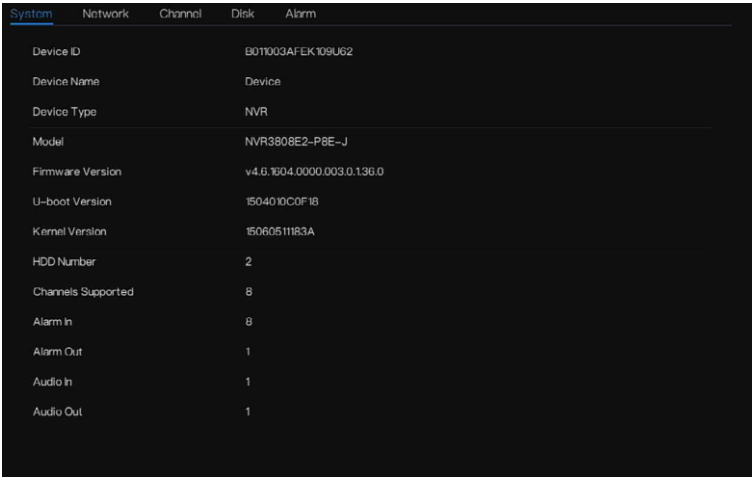

The screenshot shows the 'System' tab selected in a navigation menu. The main content area displays a list of system parameters and their values:

Parameter	Value
Device ID	B01003AFEK109U62
Device Name	Device
Device Type	NVR
Model	NVR3808E2-P8E-J
Firmware Version	v4.6.1604.0000.003.0.136.0
U-boot Version	1504010C0F18
Kernel Version	15060511183A
HDD Number	2
Channels Supported	8
Alarm In	8
Alarm Out	1
Audio In	1
Audio Out	1

Network: status, IP address, subnet mask, default gateway, MAC address, DHCP, preferred DNS server, Alternate DNS server, total band width, received packets, and so on, as shown in Figure 7-91.

Figure 7-91 Information-network interface

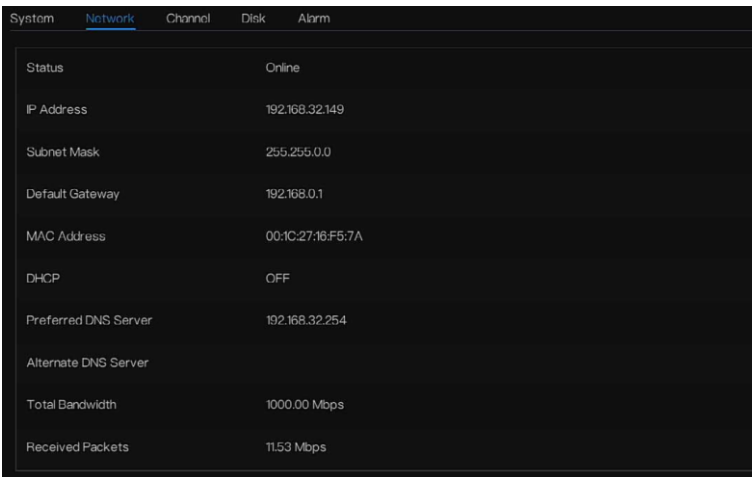

The screenshot shows the 'Network' tab selected in a navigation menu. The main content area displays a list of network parameters and their values:

Parameter	Value
Status	Online
IP Address	192.168.32.149
Subnet Mask	255.255.0.0
Default Gateway	192.168.0.1
MAC Address	00:1C:27:16:F5:7A
DHCP	OFF
Preferred DNS Server	192.168.32.254
Alternate DNS Server	
Total Bandwidth	1000.00 Mbps
Received Packets	11.53 Mbps

Channel: channel, name, status, video format, resolution, bitrate (kbps), and so on, as shown in Figure 7-92.

Figure 7-92 Information-channel interface

Channel	Name	Status	Video Format	Resolution	Bitrate(kbps)
CH1	Channel01	Online	H.265/H.265	1920*1080/704*576	4096/3024
CH2	Channel02	Offline	H.265/H.265	3840*2160/720*576	4096/768
CH3	Channel03	Online	H.265/H.265	2560*1600/1134*768	4096/3024
CH4	Channel04	Online	H.265/H.265	2560*1600/1134*768	4096/3024
CH5	Channel05	Online	H.265/H.265	1920*1080/704*480	4096/3024
CH6	Channel06	Online	H.265/H.265	704*480/352*240	2000/3024
CH8	Channel08	Offline	H.265/H.265	3840*2160/720*576	4096/768

Disk: disk name, capacity, used, SN, disk model, status, and so on, as shown in Figure 7-93

Figure 7-93 Information-disk interface

Disk	Capacity	Used	SN	Disk Model	Status
Disk1	12 TB	291 GB	5QJRV09B	WDC WD12EJRP-89B	Normal
Disk2	3 TB	1678 GB	Z6A0RABD	ST3000VX0D-2E3166	Normal

Alarm: channel, name, mode, enable, recording channel, and so on, as shown in Figure 7-94.

Figure 7-94 Information-alarm interface

Channel	Name	Mode	Enable	Recording Channel
Local-1	Sensor 1	N/O	On	
Local-2	Sensor 2	N/O	On	
Local-3	Sensor 3	N/O	On	
Local-4	Sensor 4	N/O	On	
Local->1		Close		

----End

7.5.2 General

7.5.2.1 System

Operation Steps

Step 1 Click **General** in the main menu or menu of the system management screen and choose **General** to access the system screen, as shown in Figure 7-95.

Figure 7-95 system setting screen

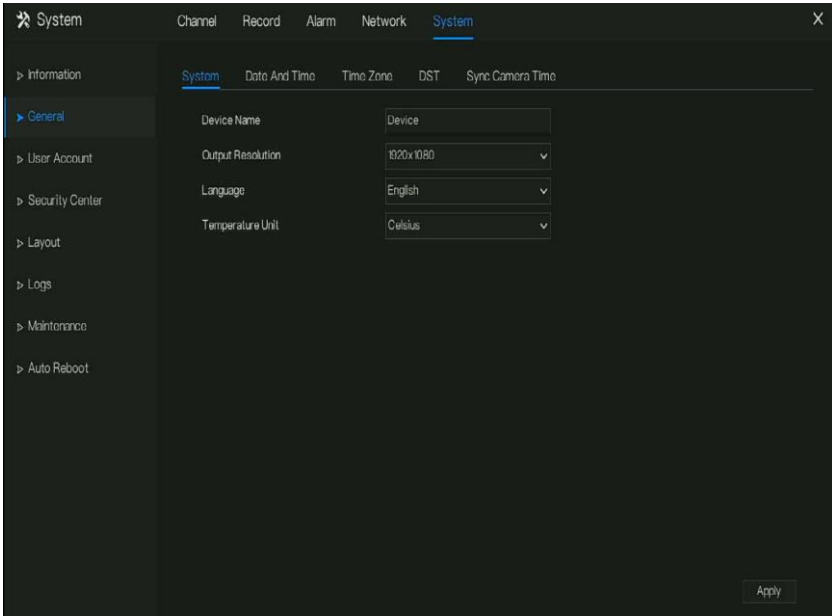

Step 2 Enter the name of the selected device.

Step 3 Select a proper resolution from the output resolution drop-down list.

Step 4 Select a required language from the Language drop-down list.

Step 5 Set the temperature unit.

Step 6 Click **Apply** to save settings.

----End

7.5.2.2 Date and Time

Operation Steps

Step 1 Click **Date and Time** page to access the date and time setting screen, as shown in Figure 7-96.

Figure 7-96 Date and Time setting screen

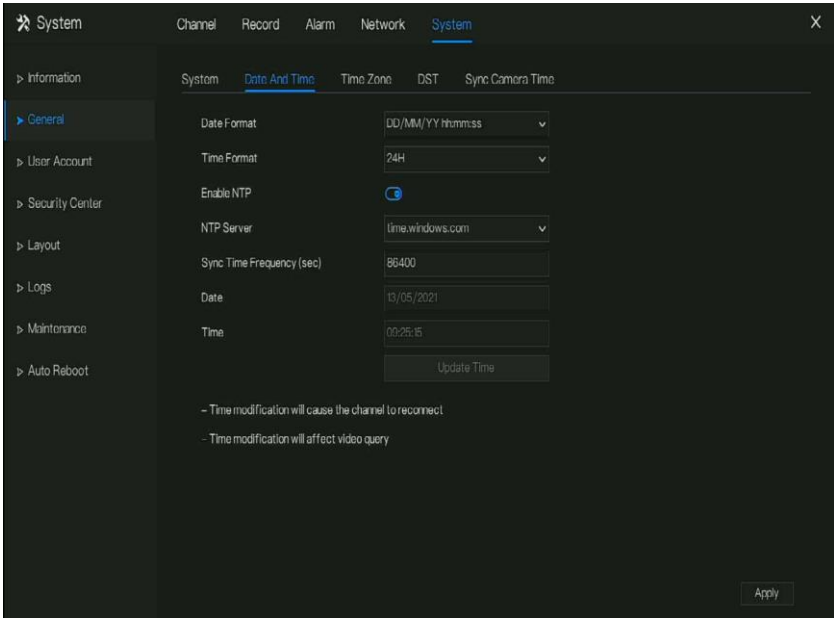

Step 2 Select required format from the Date Format and time format drop-down list.

Step 3 Click next to NTP Sync to disable time synchronization. Time synchronization is enabled by default. Time is synchronized with the NTP.

Step 4 After NTP Sync is disabled, you can manually set the system time:

- Click **Date** and use the scroll wheel to select the year, month, and date.
- Click **Time** and use the scroll wheel to select the hour, minute, and second.
- Click **Modify Time** to save the time settings.

Step 5 Click Apply to save settings.

----End

7.5.2.3 Time Zone

Operation Steps

Step 1 Click **Time zone** page to access the time zone setting screen, as shown in Figure 7-97.

Figure 7-97 Time zone setting screen

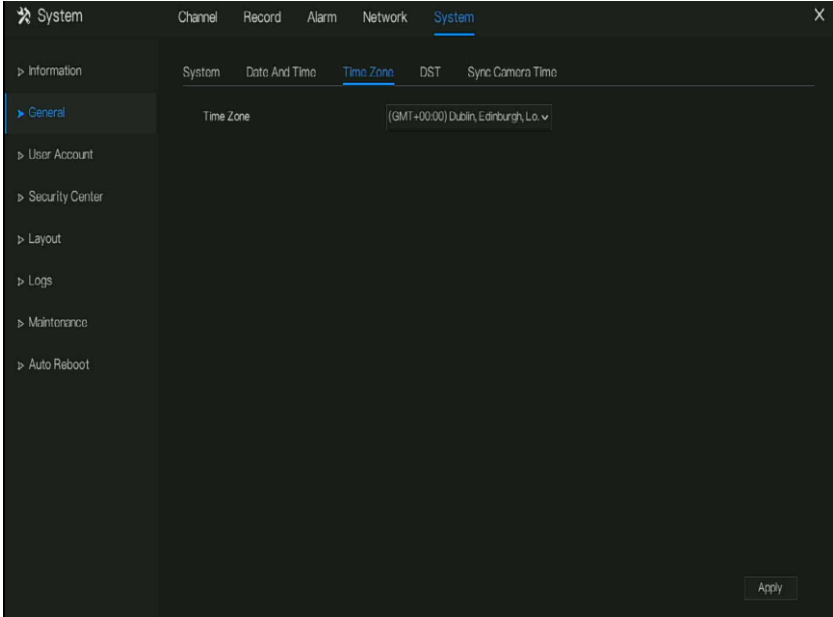

Step 2 Select a required time zone from the Time Zone drop-down list.

Step 3 Click **Apply** to save settings.

----End

7.5.2.4 DST

When the DST start time arrives, the device time automatically goes forward one hour (offset time). When the DST end time arrives, the device time automatically goes backward one hour. The offset time can change if the local rule is different.

Operation Steps

Step 1 Click **DST** to access the DST setting screen, as shown in Figure 7-98.

Figure 7-98 DST setting screen

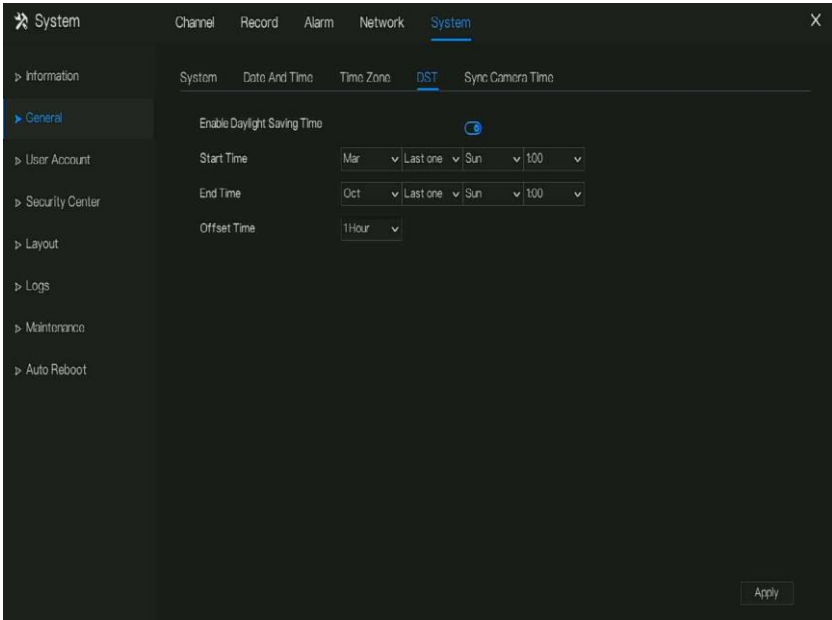

Step 2 Click  next to **DST** to enable DST.

Step 3 Select start time, end time, offset time from the drop-down list respectively, that basis on the local rules.

Step 4 Click  to save settings.

----End

7.5.2.5 Sync Camera Time

Enable the sync camera time, the channels will show the sync time, and set the frequency of check

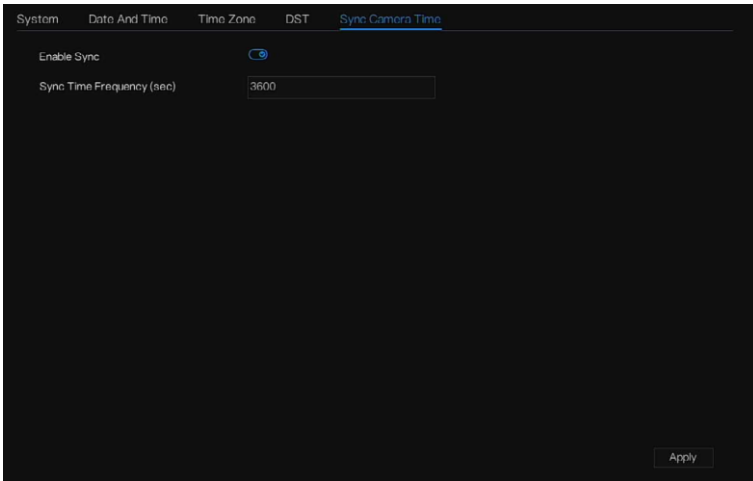

---End

7.5.3 User Account

Add, modify, and delete a user and privilege in user screen, admin user can dispose privilege to different users.

7.5.3.1 User

Operation Steps

Step 1 Click **User** in the main menu or menu of the system management screen and choose **User** to access the user screen, as shown in Figure 7-99.

Figure 7-99 User management screen

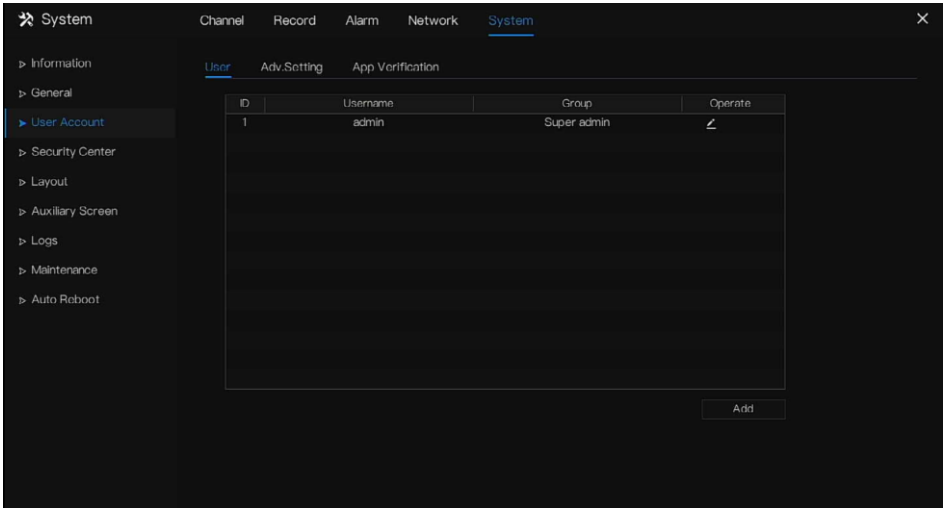

Step 2 Add or delete a user.

Add a user

Click **Add**, the **Add User** dialog box appears, as shown in Figure 7-100.

Figure 7-100 Add user screen

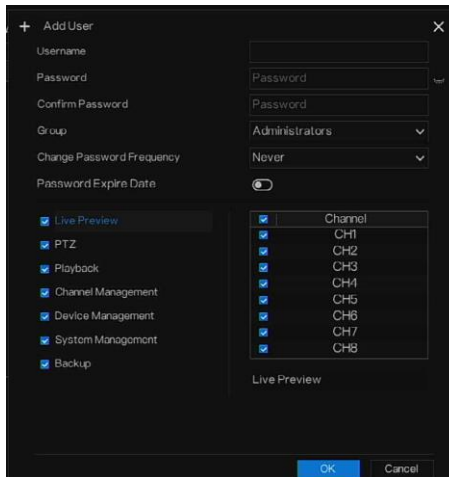

Input a username, password and confirm password, choose group and change password reminder, set the expire date.

 **NOTE**

The password should include at least two types of letters, characters and numbers.

The password should be 6~32 characters long.

Step 3 Select a **Group** from the drop-down list box.

Step 4 Select a **Change password reminder** value from the drop-down list box.

Step 5 Enable the expire date to set the new user's authority time.

Step 6 Select the operation privileges and channels in the list of the add user screen.

Step 7 Click . The user is set successfully.

 **NOTE**

The default user is **Administrator** and cannot be deleted or modified.

Select a user from user list and click  to edit, or click  to delete a user.

-----**End**

7.5.3.2 Advance Setting

Operation Steps

Step 1 Click **User** in the main menu or menu of the system management screen and choose **Adv Setting** to access the user screen, as shown in Figure 7-101.

Figure 7-101 Advance setting screen

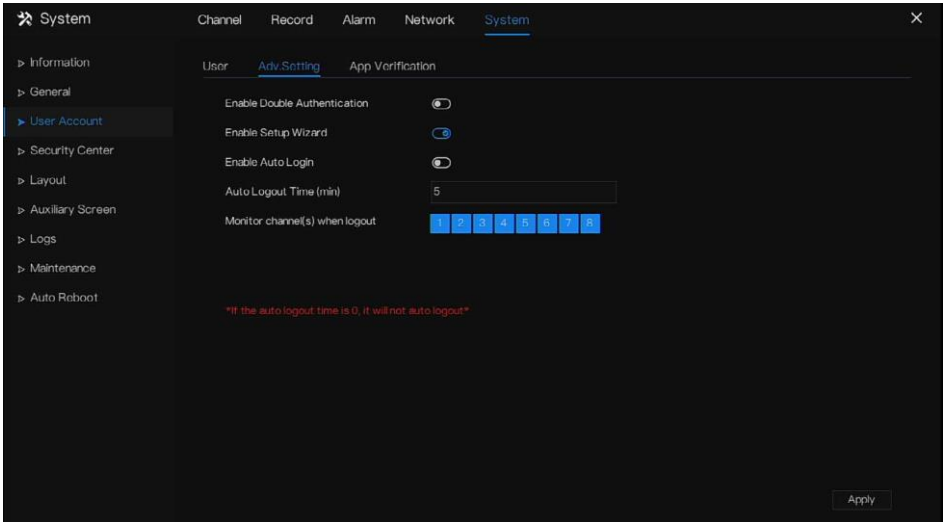

Step 2 Enable or disable Double Authentication, Auto login, Setup Wizard. Set the logout time if the user disables the auto login.

Step 3 Choose monitor channels when logout, the default is all channels.

Step 4 Click **Apply** to save settings.

-----**End**

7.5.3.3 App Verification

Add the digital number to whitelist, When log in to the mobile app to manage the NVR, enter a series of numbers in the whitelist for testing and verifying to ensure security.

Figure 7-102 App verification

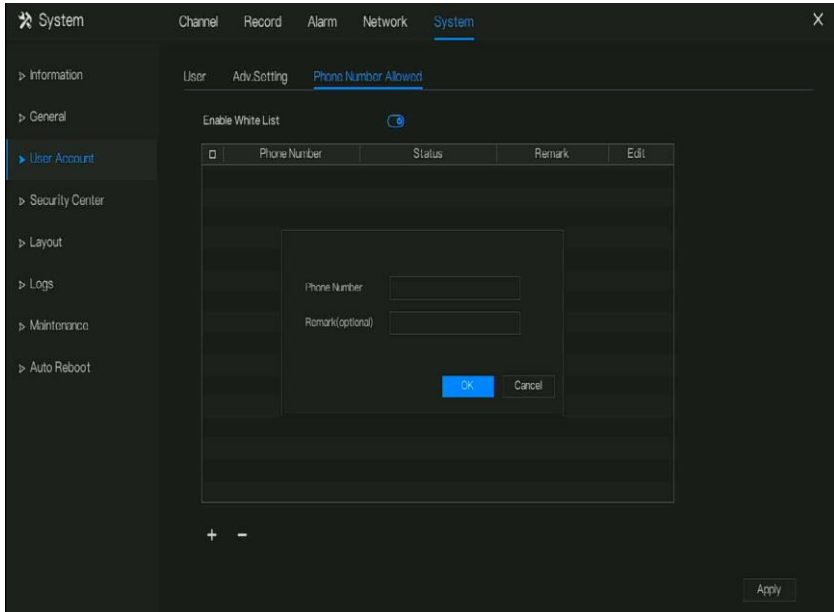

Up to 20 groups of security codes can be added and notes can be modified for them.

Tick the numbers, click “-” to delete the numbers.

Click to save the setting.

----End

7.5.4 Security Center

7.5.4.1 Password

Operation Steps

Step 1 Click **Security Center** in the main menu or menu of the system management screen and choose **Password** to access the modify password screen, as shown in Figure 7-103.

Figure 7-103 Password modification screen

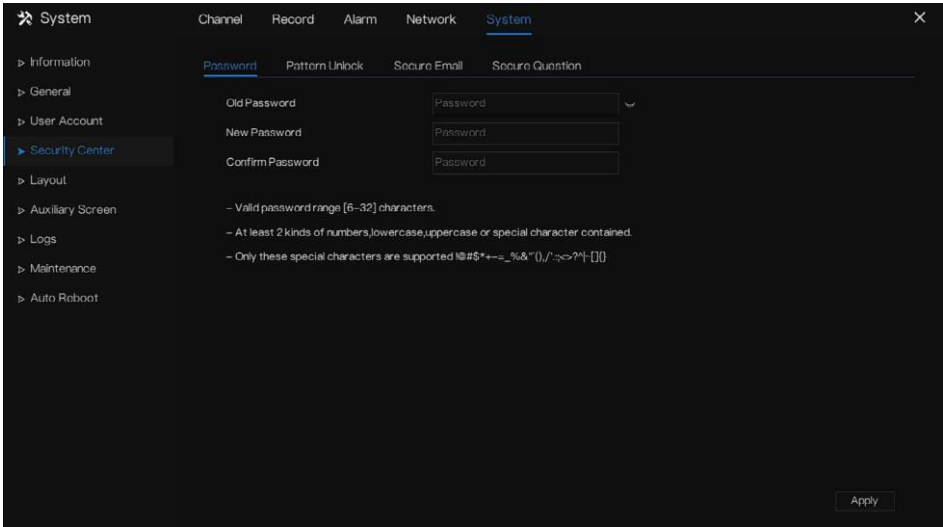

Step 2 Input the correct old password, new password, and confirm password.

 **NOTE**

The password should include at least two kinds of letter, character and number.

The password should be 6~32 characters.

Only special characters (! @#&*+=%&''(),./< >?^~[]{})) are supported,

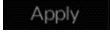
Step 3 Click  to save modified password settings.

----End

7.5.4.2 Pattern Unlock

Operation Steps

Step 1 Click **Security Center** in the main menu or menu of the system management screen and choose **Pattern Unlock** to access the modify pattern unlock screen, as shown in Figure 7-104.

Figure 7-104 Pattern unlock screen

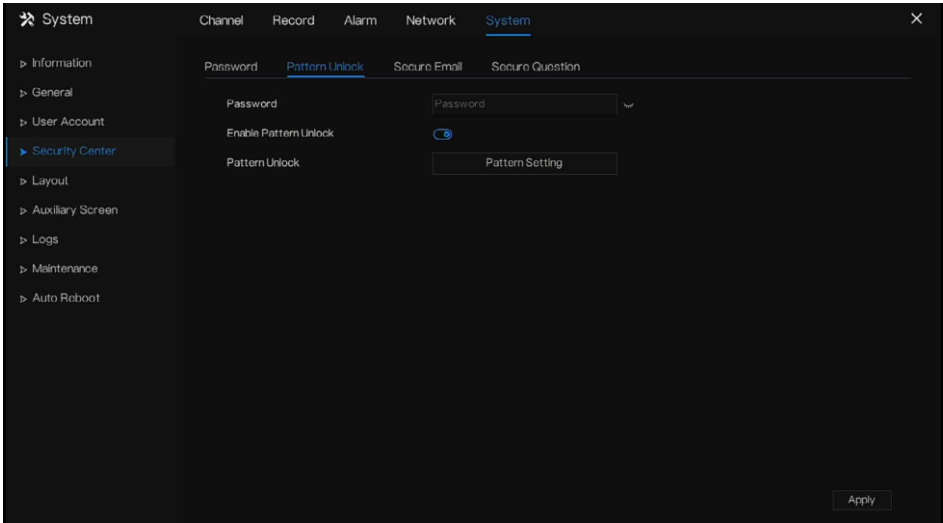

Step 2 Input the password, enable pattern unlock.

Step 3 Click **Setting Pattern** to set an new pattern unlock.

Step 4 Draw the pattern, then it will remind to draw the confirmation pattern again.

Step 5 Click **OK** to save the pattern unlock.

----End

7.5.4.3 Secure Email

Set the email to receive the verification code to create new password, as shown in Figure 7-105.

Figure 7-105 Secure Email

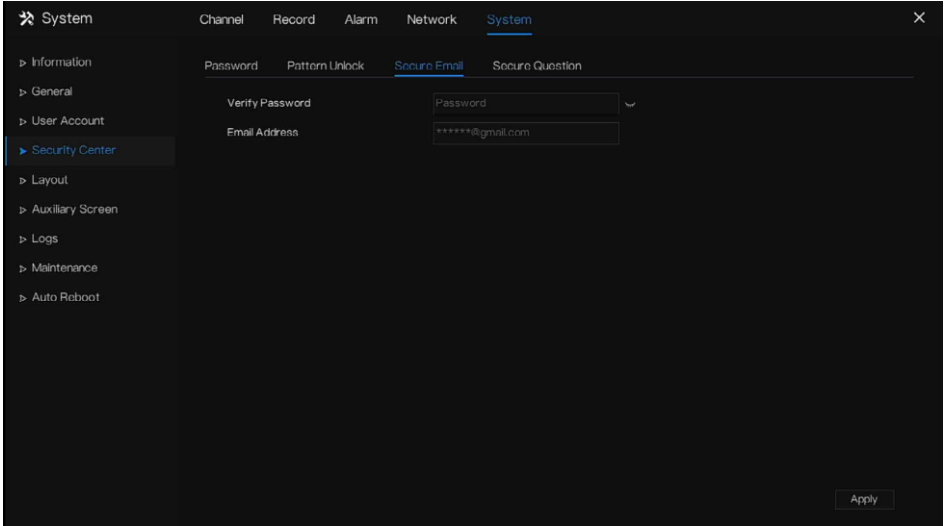

Step 1 Input the password of NVR.

Step 2 Set the Email address to receive verification code.

Step 3 Click **Apply** to save setting.

----End

7.5.4.4 Secure Question

Set the questions to create new password, as shown in Figure 7-105.

Figure 7-106 Secure question

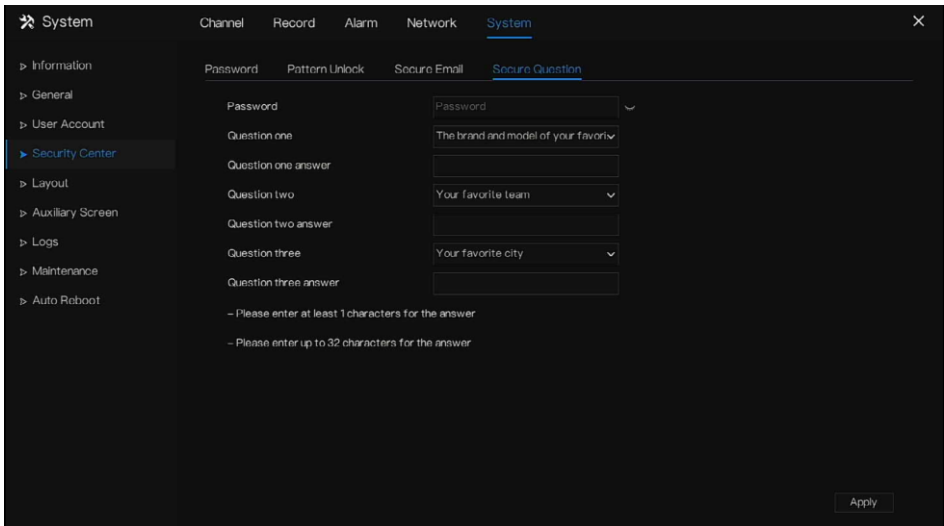

Step 1 Input the password of NVR.

Step 2 Choose the question from drop-down list.

Step 3 Input the answer, click **Apply** to save setting.

----End

7.5.5 Layout

Set viewing video mode, dwell time in display screen. The layout is set as auto sequence multiple screen.

Operation Steps

Step 1 Click **Layout** in the main menu or menu of the system management screen and choose **Layout** to access the display screen, as shown in Figure 7-107.

Figure 7-107 Auto Sequence screen

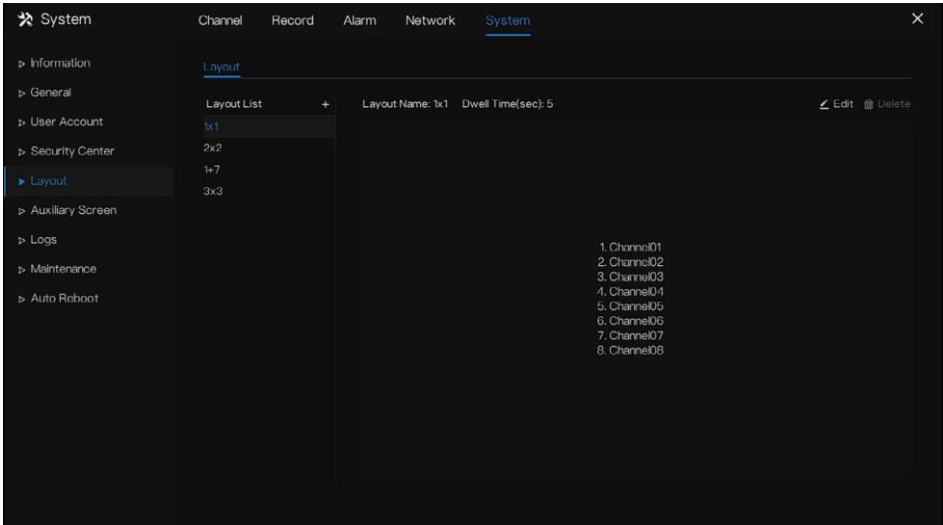

Step 2 Click “+” to add a new layout. The default layout is one splitting screen.

Figure 7-108 Add a new layout

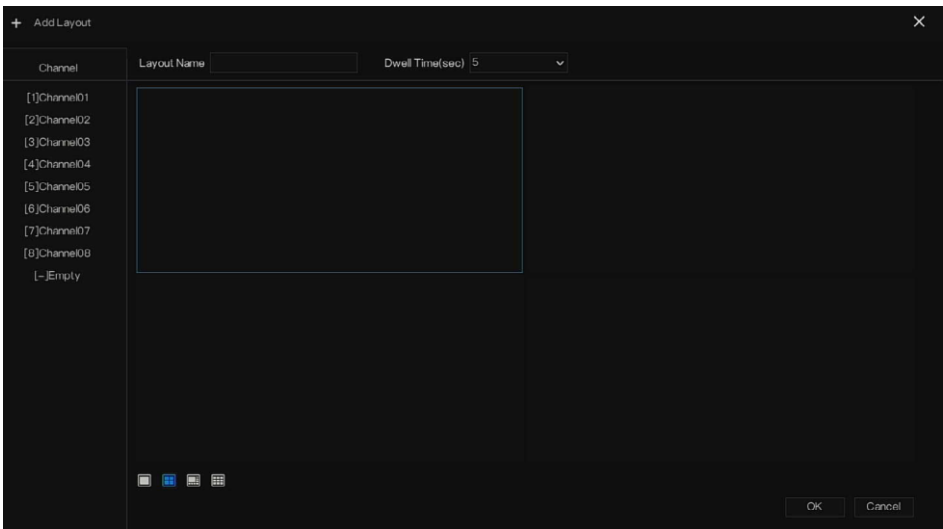

Step 3 Input the layout name, select dwell time from the SEQ Dwell time drop-down list(the display screen will loop play the real time video according to setting time).

Step 4 Select split screen mode at the bottom of the page. Set the channel display by dragging the channel to specific position, or select the position first, then click the channel. A split screen can play multiple channels. Auto sequence means it will play according to the setting. For example, the first split screen is set as two pages (channel 1 and 2), the second split screen is set as one page (channel 3). When auto sequence is enabled, channel 1 and channel 3 are displayed, then channel 2 and channel 3 are displayed.

Figure 7-109 Auto sequence

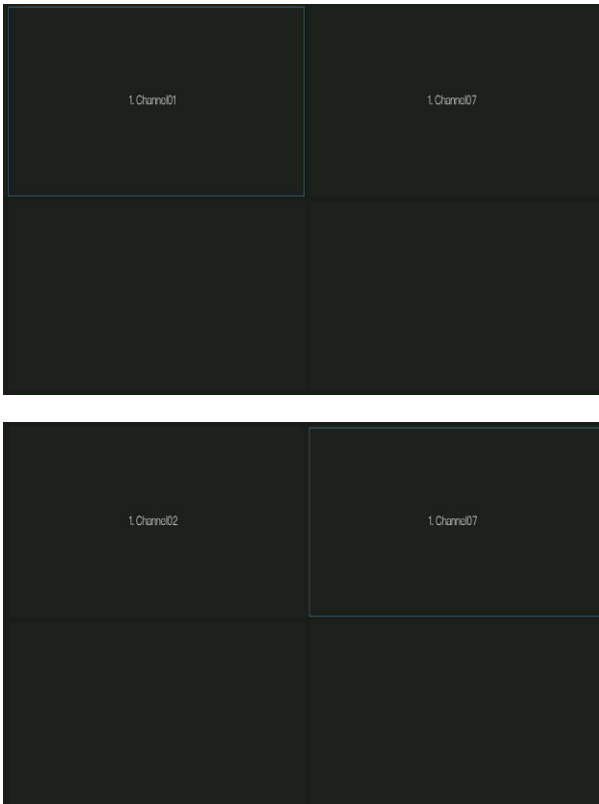

Step 5 Click **Apply** to save dwell settings.

 **NOTE**

User can add up to 16 layouts.

----End

7.5.6 Auxliary Screen (Only for Some Models)

NOTE

This function only can be used for the devices with 8 or more than channels. The main screen is connected by HDMI (HD-OUT 2), auxiliary screen is connected by VGA.

Operation Steps

Step 1 Click **Auxiliary Screen** in the main menu or menu of the system management screen.

Step 2 Enable the auxiliary screen, as shown in Figure 7-110

Figure 7-110 Auxiliary screen

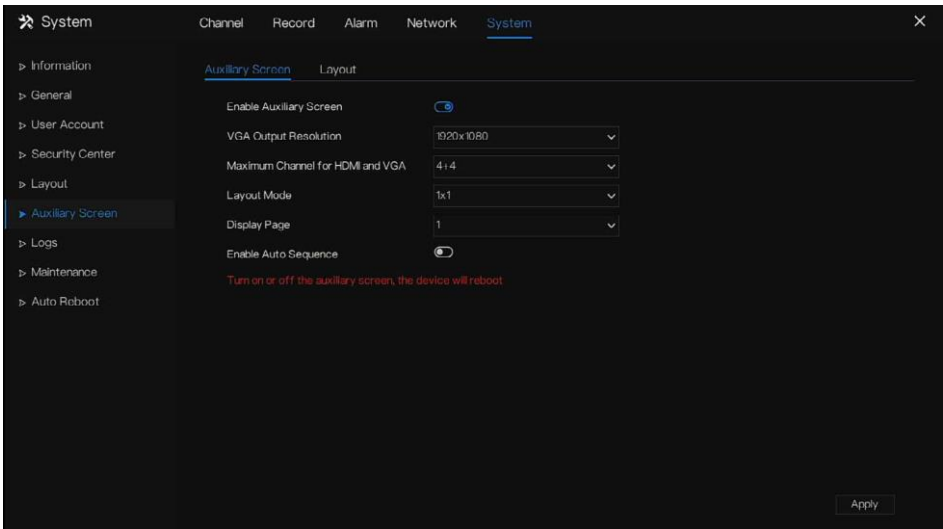

Step 3 Set the Output Resolution, Decoding Ability(main + auxiliary), Layout Mode, Display Channel.

Step 4 Enable tour to set **Auto Sequence** of auxiliary screen as shown in.

Figure 7-111 Auto sequence of auxiliary screen

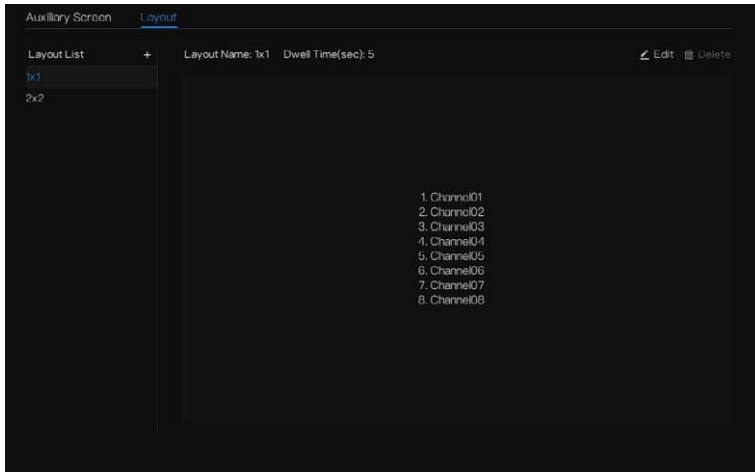

Step 5 Click **Apply** to save settings.

NOTE

The auxiliary screen shows different channels with main screen, and the auto sequence show all channels.

The auxiliary screen will show the personnel counting information if it is enabling.

---End

7.5.7 Logs

7.5.7.1 System Log

Search for logs information and export the information of logs.

Operation Steps

Step 1 Click **Logs** in the main menu or menu of the system management screen and choose **Logs** to access the log screen, as shown in Figure 7-112.

Figure 7-112 Log screen

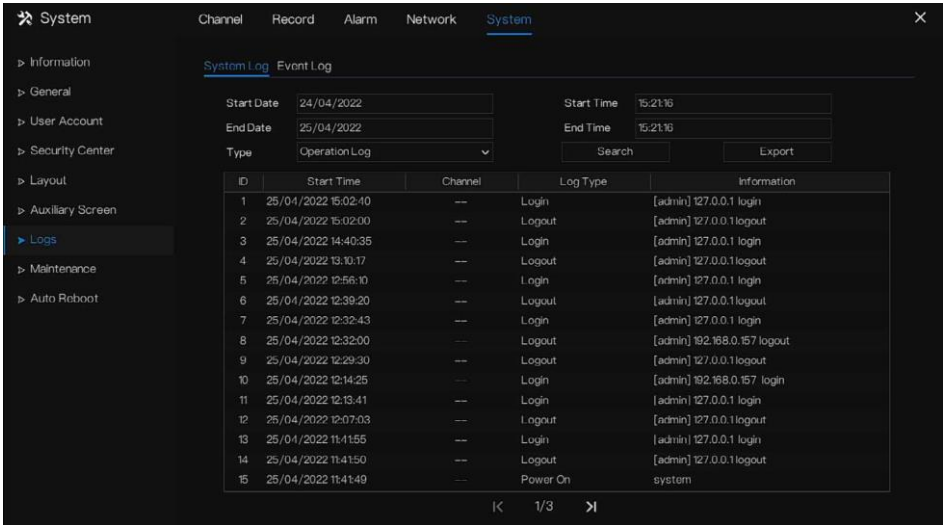

Step 2 Set start date, end date, start time and end time of the logs on log screen.

Step 3 Select logs type from the drop-down list.

Step 4 Click **Search** to query logs.

Step 5 Click **Export** to export logs to flash disk.

Step 6 the logs can be saved to flash disk and hard disk at the same time, the newest logs is saved to flash disk, and the old logs will be transferred to hard disk.

----End

7.5.7.2 Event Log

Event logs are divided into more detailed types, which can be found quickly. Its operation is the same as the system log, please refer to chapter 7.5.7.1.

Figure 7-113 Event

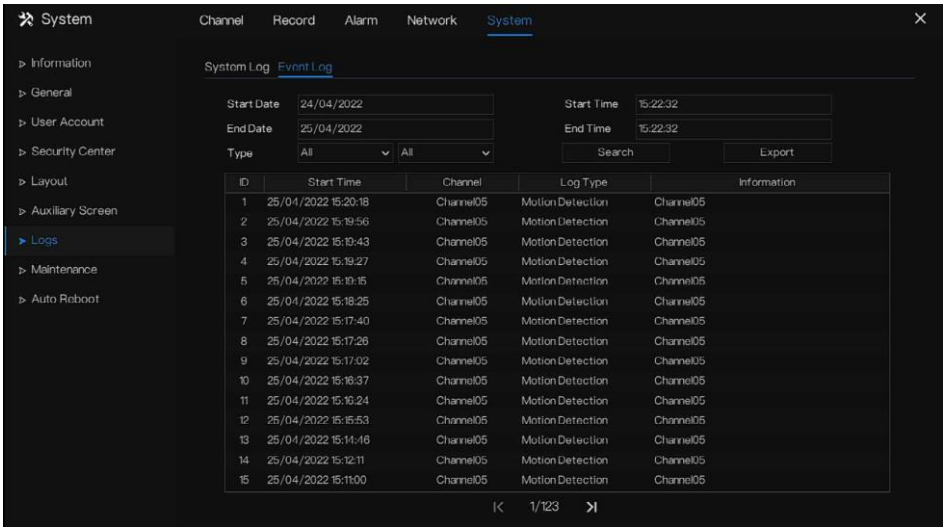

7.5.8 Maintenance

Operation Steps

Step 1 Click **Maintenance** in the main menu or menu of the system management screen and choose **Maintenance** to access the maintenance screen, as shown in Figure 7-114.

Figure 7-114 Maintenance screen

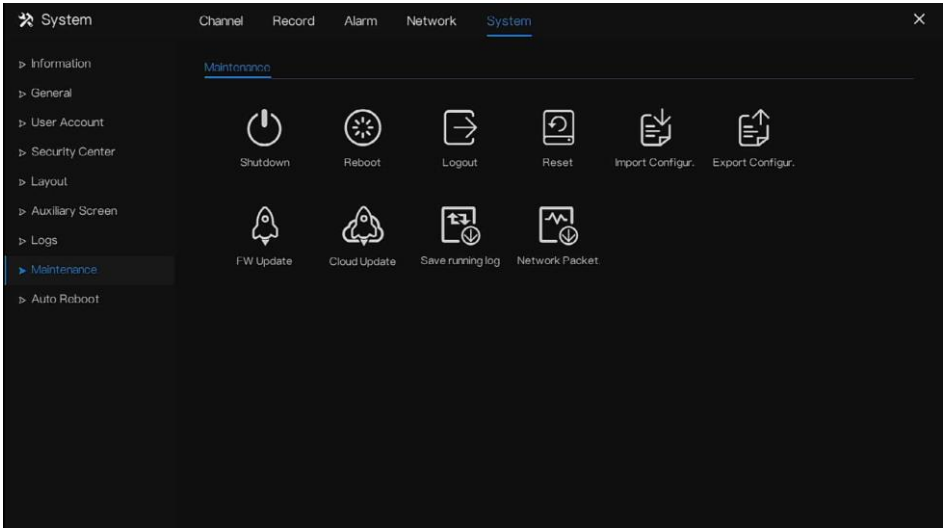

Step 2 Click Shutdown, Reboot , Logout, Exit system, Reset or update to operate NVR if you need.

Figure 7-115 Firmware update

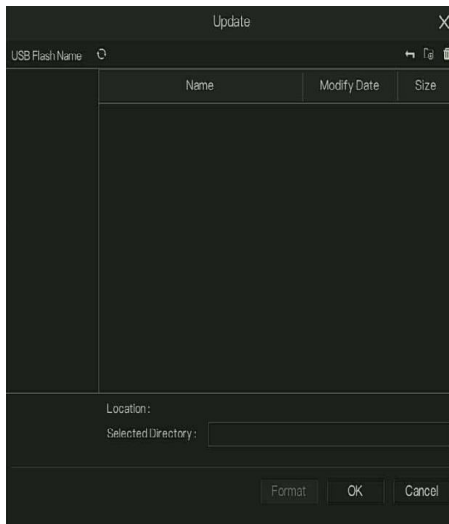

Step 3 Click import configuration or export configuration to view the message “ Are you sure to import the configuration?” Make sure the flash driver is working.

Step 4 The tips will show on screen, click **ok** to ensure choice.

Step 5 Click **Import Config** to import the configuration to flash drive.

Step 6 Import the configuration, the device would restart immediately.

Step 7 Click **Export Config** to export the configuration from flash drive.



NOTE

When the NVR finishes updating, the device would restart.

Network packet capture: the NVR is plugged into the USB disk, click the network packet capture, and set the relevant parameters of the packet capture. The captured data can be downloaded and used for device problem analysis.

FW Update, firmware update; Plug in the U disk with the update software, choose the file to update.

Save running log: In the U disk to save the running log.

----End

7.5.9 Auto Reboot

Operation Steps

Step 1 Click **Auto reboot** in the main menu or menu of the system management screen and choose **Auto reboot** to access the maintenance screen, as shown in Figure 7-114.

Figure 7-116 Auto restart screen

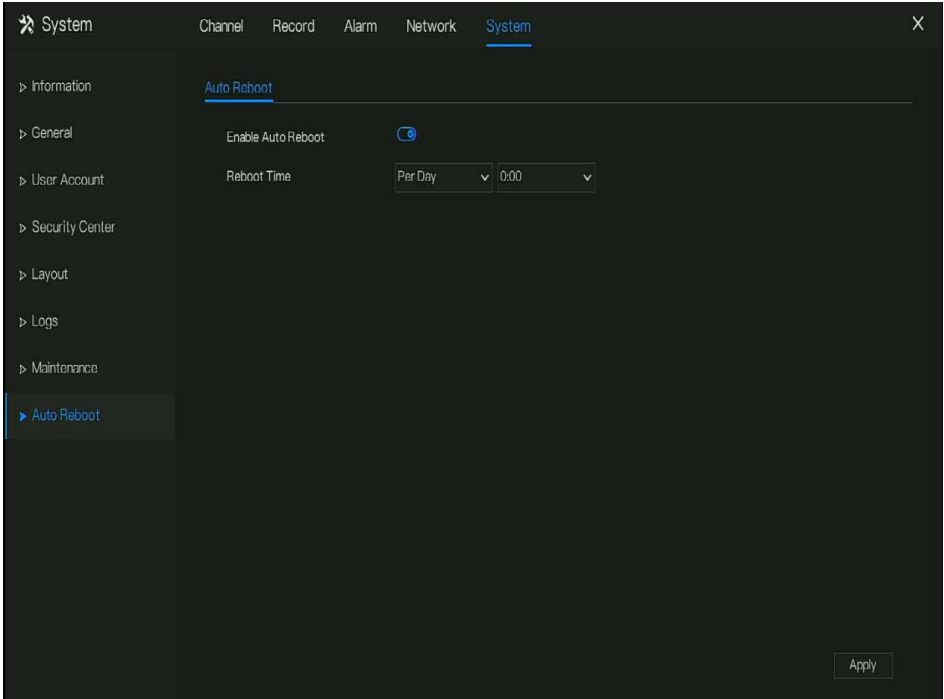

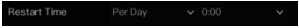
Step 2 Enable the function, restart time is showing as figure .

Step 3 Restart the NVR per day, week or month.

Step 4 Select the restart time from the drop-down list.

----End

8 WEB Quick Start

The functions of Web are the same as those of UI system, all functions can be referred to chapter 7 UI system setting.

8.1 Activation

If you don't set the password at UI interface, user need activate the device, as shown in
Figure 8-1 Activation

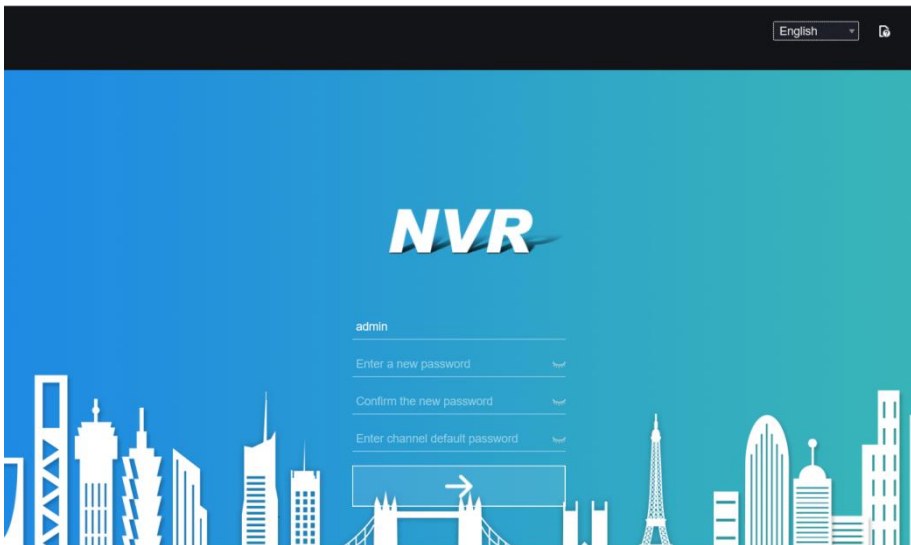

Step 1 Set the password, and confirm the password.

Step 2 Input the channel password.

Step 3 Set the email to recovery the password.

Figure 8-2 Email

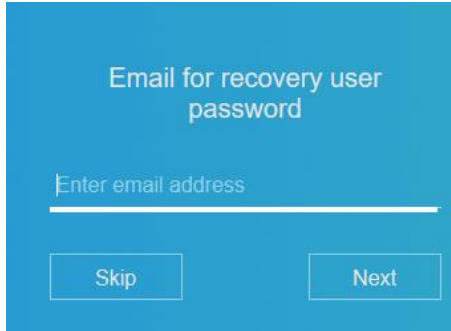

Step 4 Set the question to recovery the password.

Figure 8-3 Question

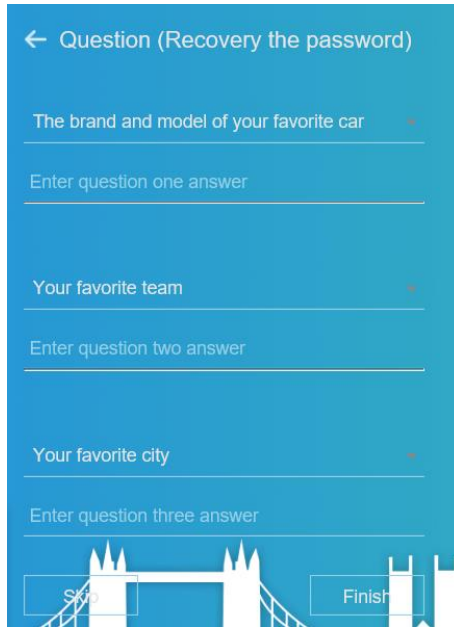

 **NOTE**

If you don't set the email or question, you can skip the steps.

8.2 Login and Logout



CAUTION

You must use Firefox 53, Chrome 45 or Edge to access the Web interface. Otherwise, the interface functions cannot be used normally.

The win 7/ win 10 system supports Firefox/Chrome, but the XP system does not.

Browser supports 32 bits systems.

Descriptions of browser:

To access the client by using Chrome 42-44, you need to enable manually Npapi in the browser according to following steps:

In the Chrome address bar, enter `chrome://flag/#enable-npapi`.

Go to the experimental features' management page.

Enable NAPAPI Mac, Windows.

Click **Enable** (NPAPI plugin is enabled).

Re-launch Chrome.

Here we take IE 10 as an example for videos viewing.

Login

Step 1 Open IE browser, enter the IP address of the NVR (default value: 192.168.0.121) in the address box, and press **Enter**.

The login page is displayed, as shown in Figure 8-4.

Figure 8-4 Login page interface

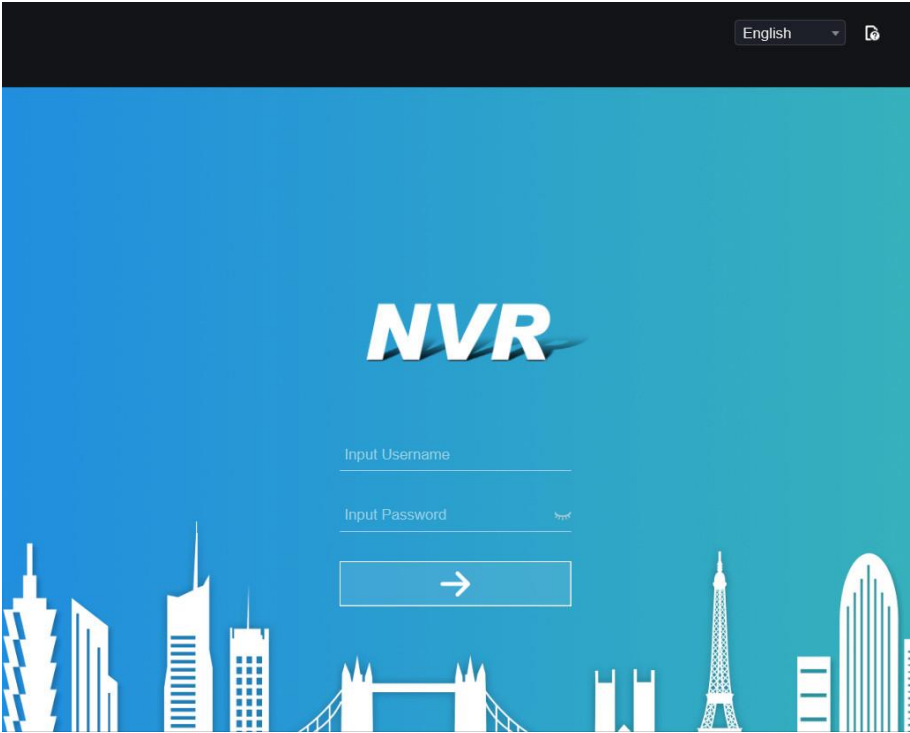

Step 2 Input the user name and password.



NOTE

The default user name and password both are admin. The password is incorrect more than 3 times, please log in again after 5 minutes.

User can change the system display language on the login page.

The modify password page pop-up window would show when login the NVR for the first time.

Step 3 Click **Login** to access the homepage, as shown in Figure 8-5.

Figure 8-5 Homepage interface 1

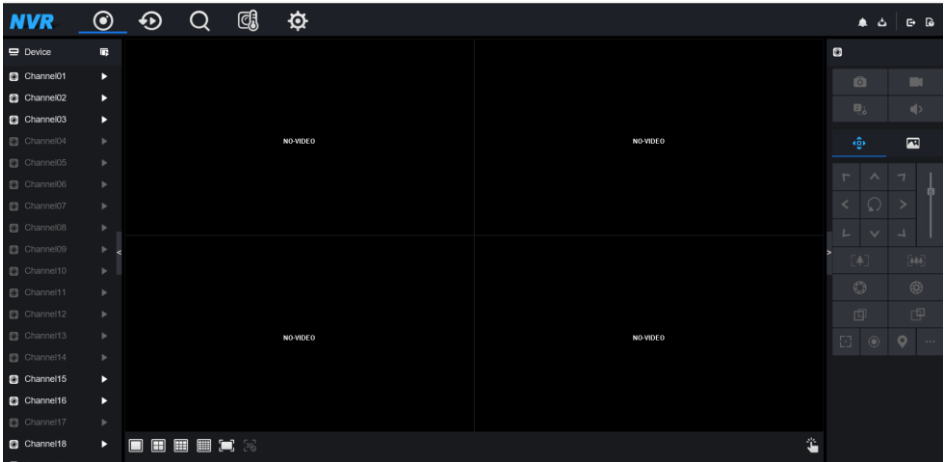

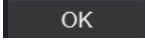

Figure 8-6 Homepage interface 2



Logout

To logout of the system, click  in the upper right corner of the homepage. The pop-up message shows “**Would you like to exit?**” Click  and the login page will display.

Homepage Layout

NVR allows you to use the Web interface in a PC for implementation of such functions as live video, playback, retrieval, setting, image parameters access, configuration, PTZ control and so on. Figure 6-8 shows the overall layout of the interface. For descriptions of the interface, please refer to Table 8-1.

Figure 8-7 Homepage layout

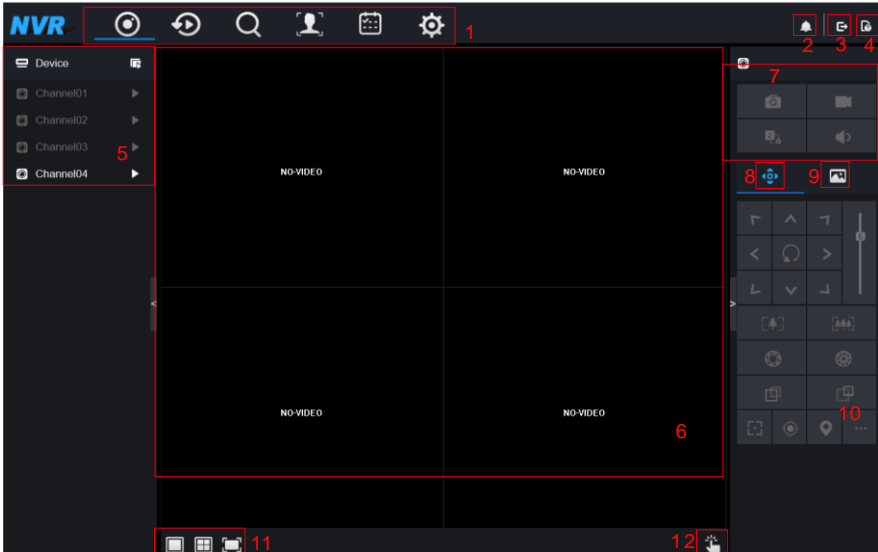





Table 8-1 Descriptions of homepage

No.	Function	Description
1	Function navigation bar	Main functions navigation bar of the device, it includes Live Video, Playback, Alarm Search, Face Recognition, Attendance and System Setting.
2	Alarm	Alarm notification. User can tick pop-up message to monitor, system alarm and channel alarm.
3	Logout button	User can click Logout to exit the current account and return to the login interface.
4	Help	Help for running environment, plug-in installation and activation.
5	Device's list	Display a list of the channels of the managed NVR and the channels managed by NVR.

6	Real-time video	Display the real-time videos of the channels managed by NVR.
7	Channel Operation	Include snapshot, record, stream switch and audio on/off.
8	PTZ control button	 <p>Click  to show PTZ control buttons in zone 10, you can control the PTZ equipment in the current channels. That function only uses for IP dome camera.</p>
9	Color parameter button	 <p>Click  to show color parameter setting buttons in zone 9, you can set and adjust the color parameters, for example, brightness, contrast, saturation, and sharpness. Click More to access image settings.</p>
10	Operation zone	The operation zone of PTZ control and image parameter setting.
11	Layouts	Select the one-screen, four-screen, nine-screen or sixteen- screen to switch the layout.
12	Manual alarm	Trigger and close the external alarm device manually.

----End

8.3 Browsing Videos

8.3.1 Browsing Real-Time Videos

You can browse real-time videos in the web management system.

Preparation

To ensure that real-time videos can be played properly, perform the following operations when you log in to the web management system for the first time:

Step 1 Open Internet Explorer. Choose **Tools > Internet Options > Security > Trusted sites > Sites**. In the displayed dialog box, click **Add**, as shown in Figure 8-8.

Figure 8-8 Adding a trusted site

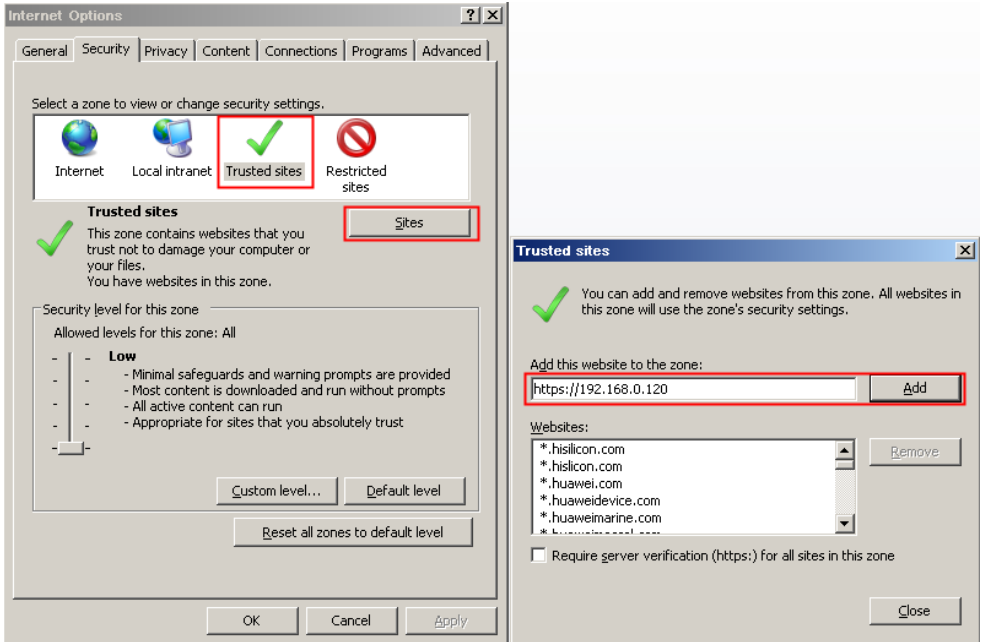

Step 2 In Internet Explorer, choose **Tools > Internet Options > Security > Customer level**, and set Download unsigned ActiveX controls and Initialize and script ActiveX controls not marked as safe for scripting under ActiveX controls and plug-ins to Enable, as shown in Figure 8-9.

Figure 8-9 Configuring ActiveX controls and plug-ins

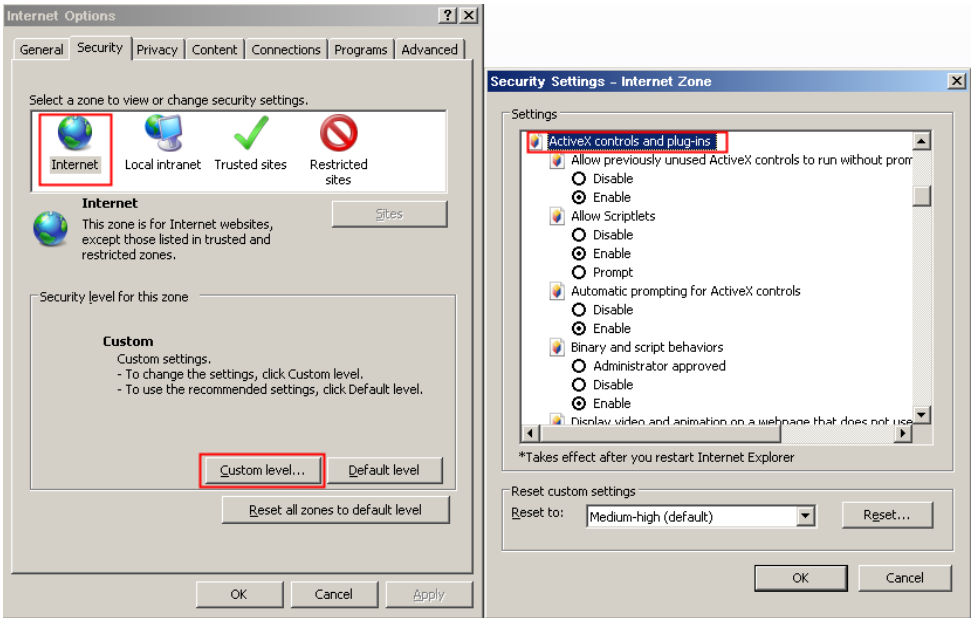

Step 3 Download and install the player control as prompted. During installing, you need to close the browser.

NOTE

If the repair tips displayed when installing the control , close the browser and continue the installation, reopen the login page when the control is installed.

8.3.2 Live Video

Descriptions

After login the device, click online channel, you can view the real-time videos, as shown in Figure 8-10.

Figure 8-10 Real-time videos interface

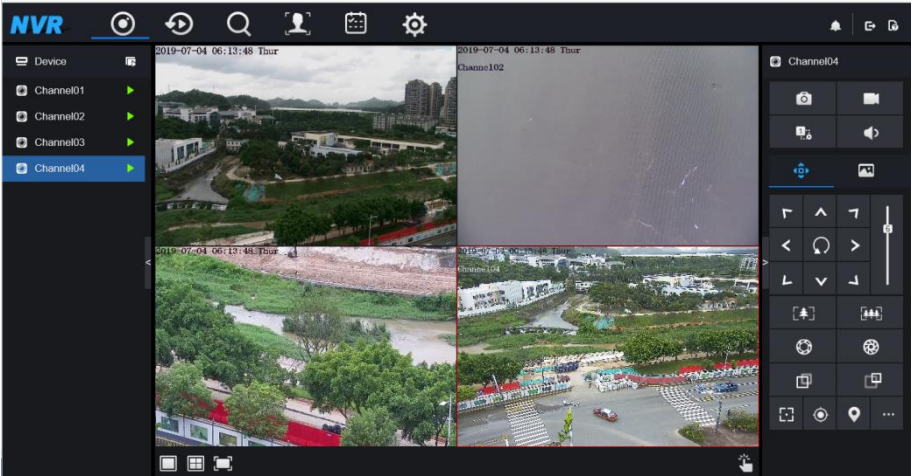





----End

8.3.3 Channel Operation

Descriptions

Channel operation includes snapshot, record, stream switch and audio on/off. Table 8-2 describes the operations.

Table 8-2 Descriptions of homepage

Buttons	Button description	How to operate
	Snapshot	Click button to take snapshots of the current image.
	Record	Click button to start recording and click button again to stop recording.
	Switch stream	Click button to switch stream 1 (main stream) and stream 2(sub stream).
	Enable/Disable video	Click button to enable the audio and click again to disenable the video.

----End

8.3.4 PTZ Control and Setting

Descriptions

The PTZ control and setting function applies only to Network Dome or camera connected to an external PTZ.

PTZ Setting

If a Network Dome or a camera connected to PTZ had been added to the NVR channel, users can control the PTZ rotation to adjust their shooting angle when you are viewing the video. This allows you to perform Omni-directional video surveillance.















Click , the PTZ operation and setting interface is as shown in Figure 8-11. Table 8-3 describes the operations.

Figure 8-11 PTZ control interface



Table 8-3 Device parameters

Buttons	Button description	How to operate
	Direction key	Click button to control omni-directional movement of the PTZ.
	Speed slider	Drag the slider to adjust the value of PTZ rotation speed.

Buttons	Button description	How to operate
	Zoom in	Click buttons to adjust the focal length.
	Zoom out	
	Iris+	Click buttons to adjust the aperture.
	Iris-	
	Far focus	Click buttons to adjust the focal length.
	Near focus	
	Auto focus	Click button to focus automatically.
	Home preset	N/A
	Preset	The camera is set the tour, click the button and dome camera rotate as the setting.
	More	More settings, scan and tour

8.3.5 Sensor Setting

Descriptions

The sensor setting can adjust scene, brightness, sharpness, contrast and saturation, click  to access image setting, as shown in Figure 8-12. Table 8-4 describes the operations.

Figure 8-12 Image parameter interface

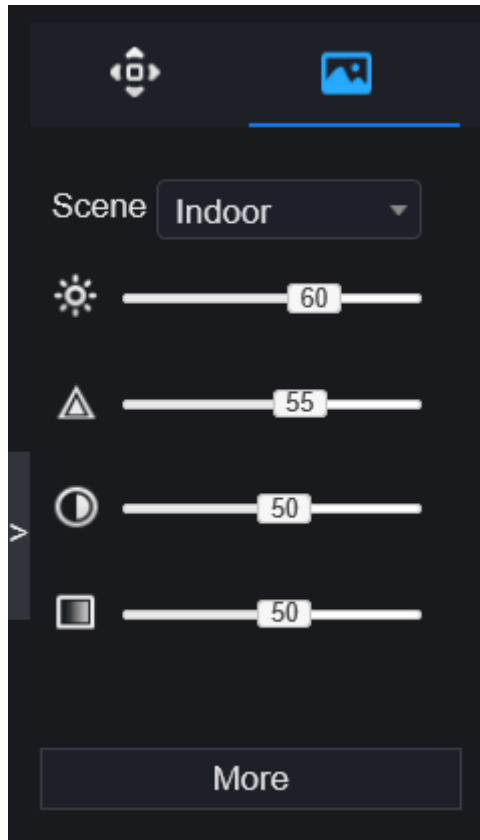



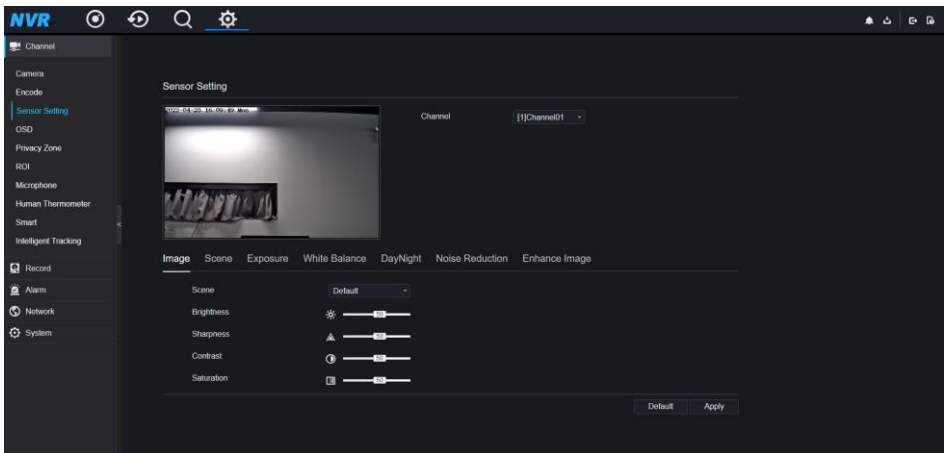

Table 8-4 Device parameters

Buttons	Button description	How to operate
	Brightness	Click button to adjust the image brightness.
	Sharpness	Click button to adjust the image definition.
	Contrast	Click button to adjust the transparency of the image.
	Saturation	Click button to adjust the chromatic purity of the image.

Click more will be access to system sensor setting. As shown in Figure 8-13, for more detail please refer to *chapter Figure 4-7*.



Figure 8-13 Sensor setting interface



----End

8.3.6 Layout



Click    at the bottom left corner of real-time videos interface, the buttons indicate 1 screen, 4 screens and 9 screens from left to right. The device with more POE ports can support 16 screens layout.

----End

8. 4 Playback

8.4.1 Video Playback

Video playback refers to playing of videos stored in local hard disks.

Procedure



Step 1 Click  in the function navigation bar, the video playback interface is displayed, as shown in Figure 8-14.

Figure 8-14 Video playback



Step 2 Select a channel. Click a device in the device list. A selected device is marked with .

The unselected device is marked with .

Step 3 Select a date from calendar at left bottom, the date will be colored if it has record as shown in upper figure.

Step 4 Tick the type of record, such as schedule record, manual record and alarm record.

Step 5 Display videos.

After a device and date are selected, video information is displayed below the video pane. The time scale above the file axis shows the different time points of video recording. The time in blue in the middle is the time of the video playing.

The file axis displays videos. The blue file axis indicates a video exists, grey file axis indicates no video exists.

You can drag the axis to play recording quickly.

Step 6 Play a video.

You can play a video after selecting a device and date. Figure 8-15 shows the control bar of video playback.

Figure 8-15 Control bar

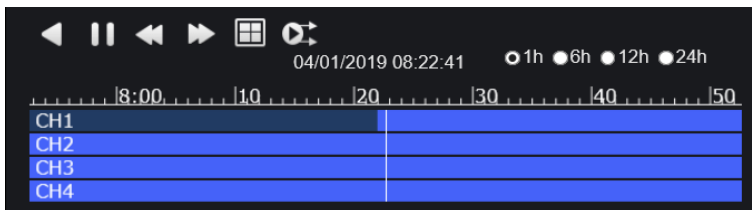

: reversed.



: play/pause.



: triple speed.



: split screen. One or four screens.



: sync/async. You can set the different channels to play synchronously or asynchronously.

Sync mode indicates the selected channels play video synchronously. Async mode indicates users play different time period record

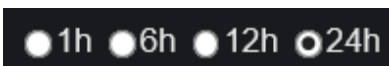

: types of time bar.

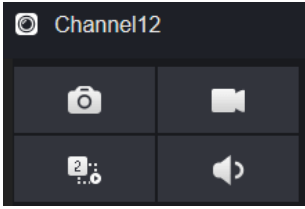

: user can operate the record as same as live video.

----End

8.5 Alarm Search

You can search for channel alarm and system alarm in the alarm search interface.

8.5.1 Channel Alarm

Procedure

Step 1 Click  in the function navigation bar, the channel alarm interface is displayed, as shown in Figure 8-16.

Figure 8-16 Channel alarm interface



Step 2 Choose the alarm type to search.

Step 3 Click **Search**, the result will be displayed as shown in Figure 8-17.

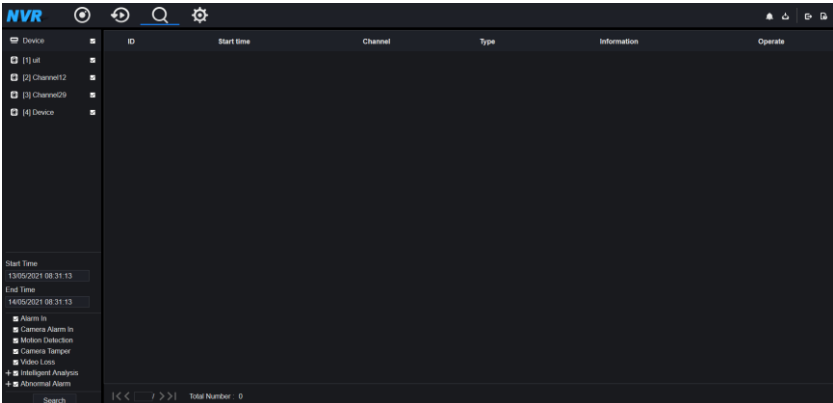
Figure 8-17 Channel alarm result

ID	Start time	Channel	Type	Information	Operate
1	25/04/2022 16:10:12	Channel05		Channel05	🔄 ⬇️ 🗑️
2	25/04/2022 16:05:11	Channel05	Motion Detection	Channel05	🔄 ⬇️ 🗑️
3	25/04/2022 16:04:38	Channel05	Motion Detection	Channel05	🔄 ⬇️ 🗑️
4	25/04/2022 16:04:14	Channel04	Video Loss	Channel04	🔄 ⬇️ 🗑️
5	25/04/2022 16:04:14	Channel03	Video Loss	Channel03	🔄 ⬇️ 🗑️
6	25/04/2022 16:03:37	Channel05	Motion Detection	Channel05	🔄 ⬇️ 🗑️
7	25/04/2022 16:02:18	Channel05	Motion Detection	Channel05	🔄 ⬇️ 🗑️
8	25/04/2022 16:00:17	Channel05	Motion Detection	Channel05	🔄 ⬇️ 🗑️
9	25/04/2022 15:57:37	Channel05	Motion Detection	Channel05	🔄 ⬇️ 🗑️
10	25/04/2022 15:54:33	Channel05	Motion Detection	Channel05	🔄 ⬇️ 🗑️
11	25/04/2022 15:52:02	Channel05	Motion Detection	Channel05	🔄 ⬇️ 🗑️
12	25/04/2022 15:51:01	Channel05	Motion Detection	Channel05	🔄 ⬇️ 🗑️
13	25/04/2022 15:49:16	Channel05	Motion Detection	Channel05	🔄 ⬇️ 🗑️
14	25/04/2022 15:48:56	Channel05	Motion Detection	Channel05	🔄 ⬇️ 🗑️
15	25/04/2022 15:47:34	Channel05	Motion Detection	Channel05	🔄 ⬇️ 🗑️
16	25/04/2022 15:43:06	Channel05	Motion Detection	Channel05	🔄 ⬇️ 🗑️
17	25/04/2022 15:42:11	Channel05	Motion Detection	Channel05	🔄 ⬇️ 🗑️
18	25/04/2022 15:41:20	Channel05	Motion Detection	Channel05	🔄 ⬇️ 🗑️

NOTE

Click to select the page of alarm list.

shows the rows shown in every page.

----End

8.6 Attendance (Only for Some Models)

8.6.1 Attendance Data

Click to enter attendance data interface, as shown in Figure 8-18.

Figure 8-18 Attendance data

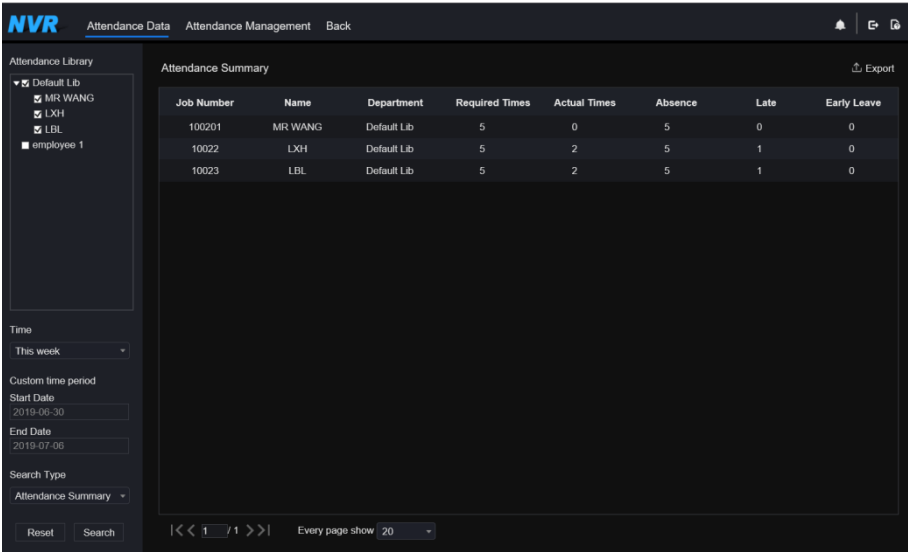

The screenshot shows the NVR Attendance Data interface. On the left is the Attendance Library with a tree view containing Default Lib, MR.WANG, LXH, LBL, and employee 1. Below the library are filters for Time (This week), Custom time period (Start Date: 2019-06-30, End Date: 2019-07-06), and Search Type (Attendance Summary). The main area displays an Attendance Summary table with the following data:

Job Number	Name	Department	Required Times	Actual Times	Absence	Late	Early Leave
100201	MR.WANG	Default Lib	5	0	5	0	0
10022	LXH	Default Lib	5	2	5	1	0
10023	LBL	Default Lib	5	2	5	1	0

At the bottom of the table, there are navigation controls: | << 1 / 1 >> | and a dropdown for 'Every page show 20'.

Operation Steps

- Step 1 Tick the attendance library.
- Step 2 Choose time mode, such as today, this week, this month and custom time.
- Step 3 Choose search type, such as attendance summary and attendance details.
- Step 4 Click search, the result will show in interface.
- Step 5 Click Export to export the query result.

----End

8.6.2 Attendance Management

In attendance management, user can set attendance rule, library and check point, as shown in Figure 8-19.

Figure 8-19 Attendance rule settings

The screenshot shows the 'Attendance Rule Settings' page in the NVR web interface. The page has a dark theme. At the top, there is a navigation bar with 'NVR' logo, 'Attendance Data', 'Attendance Management' (selected), and 'Back'. Below the navigation bar, there is a sidebar with three items: 'Attendance Rule Set...' (selected), 'Attendance Library', and 'Attendance Check P...'. The main content area is titled 'Attendance Rule Settings' and contains the following fields:

- Working Time:** Start-work time: 10:00, End-work time: 17:00
- Workday Setting:** Sunday Monday Tuesday Wednesday Thursday Friday Saturday
- Check-in valid time:** Before start-work time: 90 min, to After start-work time: 30 min
- Check-out valid time:** Before end-work time: 30 min, to After end-work time: 240 min
- Rules:**
 - If employee does not check in when starting work, mark as absent
 - If employee does not check out when ending work, mark as absent
- Apply** button

Operation Steps

Step 1 Set start work time and end work time.

Step 2 Tick the workdays.

Step 3 Set valid time of check in and check out.

Step 4 Click Save to save the setting.

Attendance library

Step 1 Click **Attendance Library** to add library, the attendance library can call the face database directly.

Figure 8-20 Attendance library

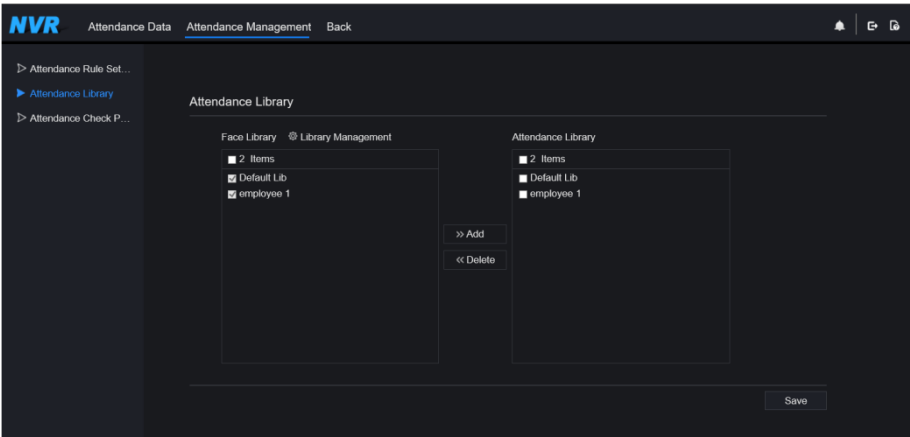

Step 2 Tick the library and click **Add** to add to attendance library. If you want to modify the library, please enter to library interface to change parameters..

Step 3 click **Database management** to enter the face database management to modify parameter.

Step 4 Click **Save** to save the setting.

Attendance check point settings:

Step 1 Click Attendance check point settings to set point, as shown in Figure 8-21.

Figure 8-21 Attendance check point setting

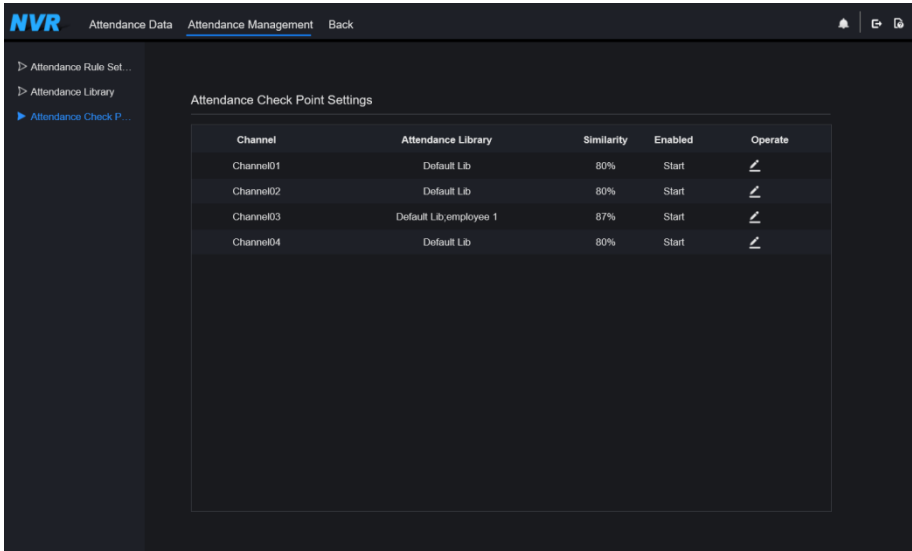

Step 2 Click  to edit check point setting, as shown in Figure 8-22

Figure 8-22 Check point



Step 3 Enable the function, set similarity and tick the library, all face detection cameras can be set the check points.

Step 4 Click OK to save the setting.

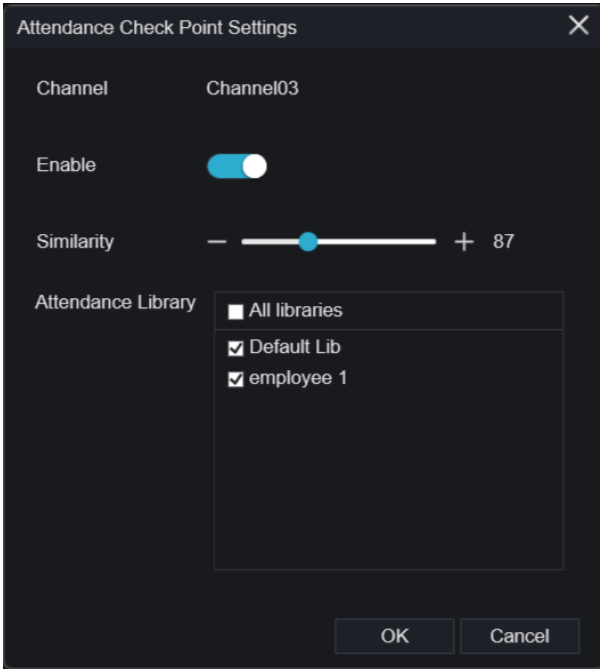
----End

8.7 AI Recognition (Only for Some Models)

At AI recognition interface, we can set the **Real time Comparison, Smart search, Archives library, Comparison configuration.**

8.7.1 Real Time Comparison

Real time comparison can compare human face, vehicle license plate, and AI(include riding, vehicle, full body)

8.7.1.1 Human Face

At real time comparison interface, click the  to enter the human face comparison interface, choose the cameras with face recognition function to play live video, the snapshot of camera will be compared with libraries, the result shows as in Figure 8-23.

Figure 8-23 Human face comparison



Click the “+” to add the snapshot to face library immediately.

----End

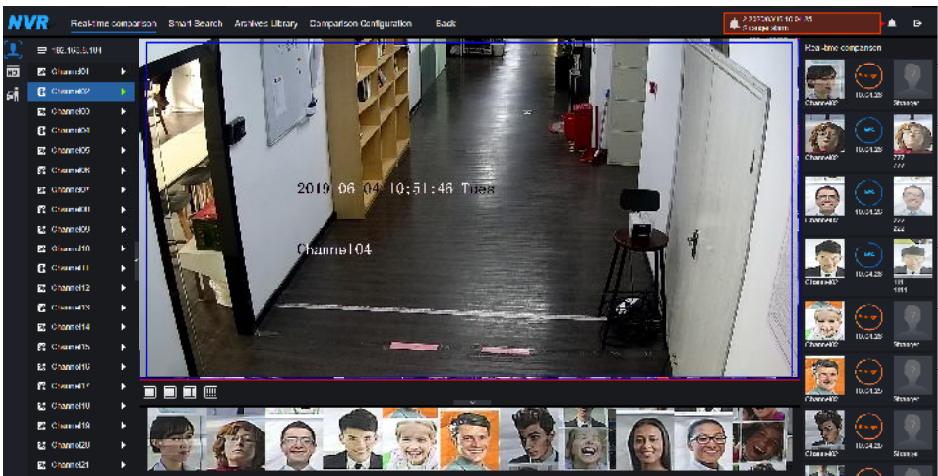
8.7.1.2 Vehicle License Plate



At real time comparison interface, click the  to enter the vehicle license plate comparison interface, choose the cameras with license plate recognition function to play live video, the snapshot of camera will be compared with libraries, the result shows as in Figure 8-24.

Figure 8-24 Vehicle license plate

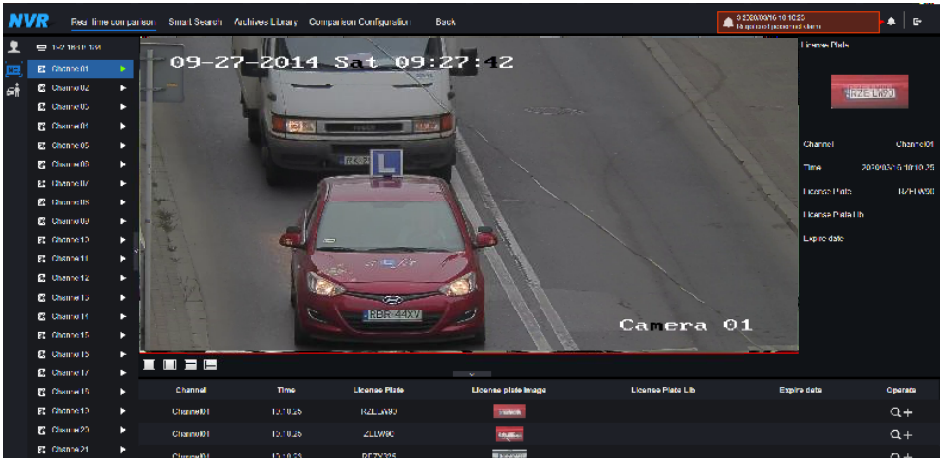

Click the “+” can add the snapshot to license plate library immediately.

To get snapshot in real time video, put the cursor on picture such as , you can add it to face library, or face search. The cursor on area 6 and the pictures are not update, move the mouse so that the pictures can be shown in time.

----End

8.7.1.3 Vehicle and Full Body

At real time comparison interface, click the  to enter the vehicle license plate comparison interface, choose the AI recognition cameras to play live video, the snapshot of camera will compare with libraries, the snapshot to vehicle and full body will show at the bottom of page, the result shows as in Figure 8-25.

Figure 8-25 Full body



8.7.1.4 Real Time Body Temperature Filter

The real time body temperature will show the snapshot of device, it shows the over temperature and snapshot to human face.

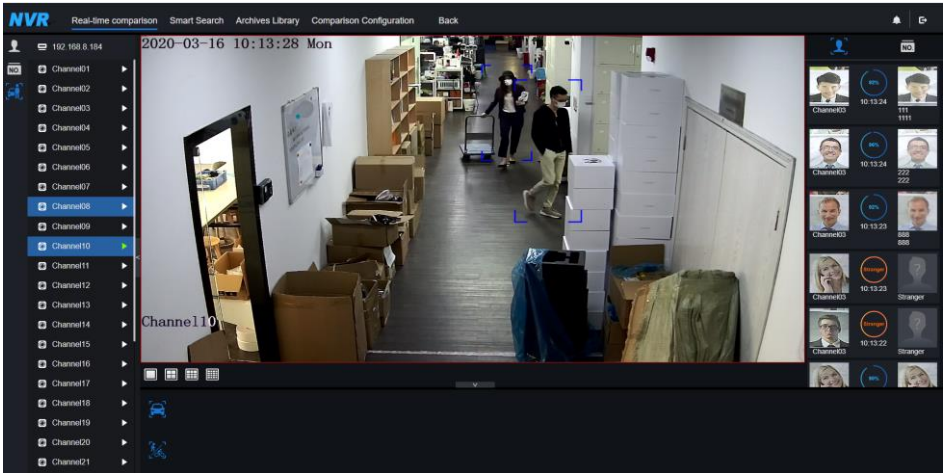
Snapshot will show the characteristic such as no mask (the mask detection configuration can be set at comparison configuration interface )

Figure 8-26 Body temperature

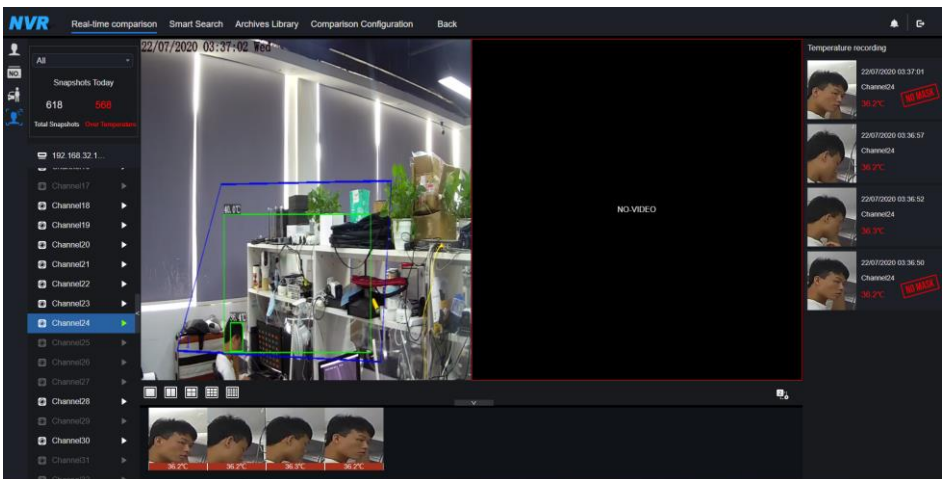

----End

8.7.2 Smart Search

At smart search interface, users can search the human face, vehicle license plate, full body, car, body temperature.

8.7.2.1 Human Face Search

Figure 8-27 Human face search

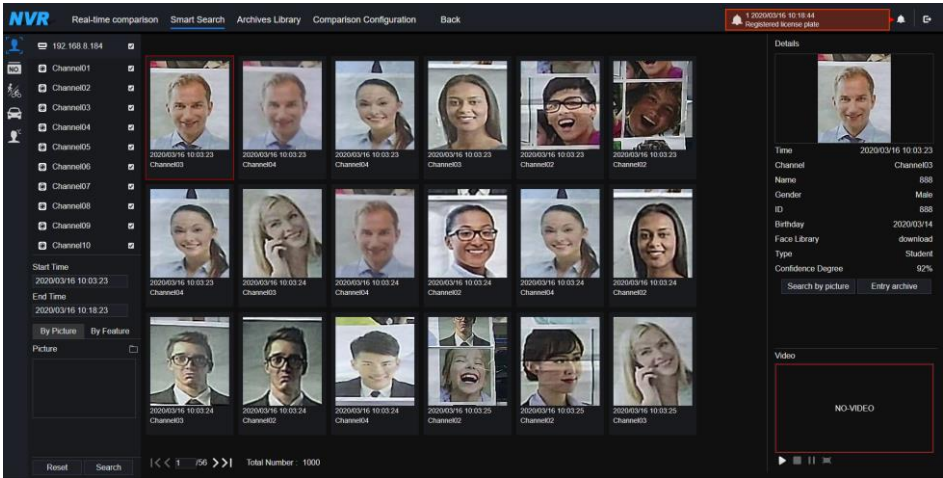

Step 1 Choose human face search at smart search interface.

Step 2 Tick the face recognition camera channels, set the start time and end time.

Step 3 Choose the condition (by picture or by feature), the picture can be chosen from the file folder.

Step 4 Click “Search” to search the snapshot of human face.

Step 5 The result will show at the middle of page, click the picture and detailed information at the top right of page.

Step 6 Detailed picture can be used to search or add to library.

Step 7 Click play button of video to play the recordings of snapshot.

----End

8.7.2.2 Vehicle License Plate Search

Figure 8-28 Vehicle License Plate search

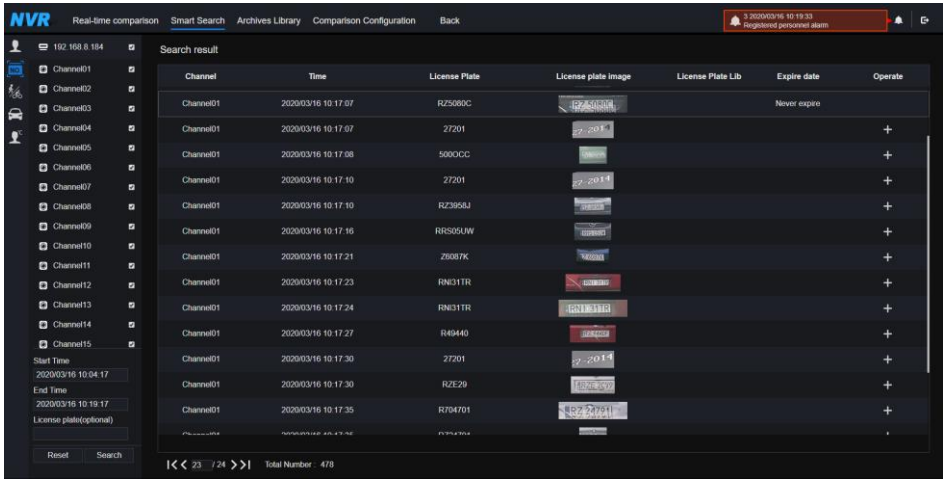

Step 1 Choose vehicle License Plate at smart search interface.

Step 2 Tick the vehicle license plate recognition camera channels, set the start time and end time.

Step 3 Input the license plate optionally.

Step 4 Click “Search” to search the snapshot of license plate.

Step 5 The result will show at the page, click “+” add to library.

----End

8.7.2.3 Full Body Search

Figure 8-29 Full body search

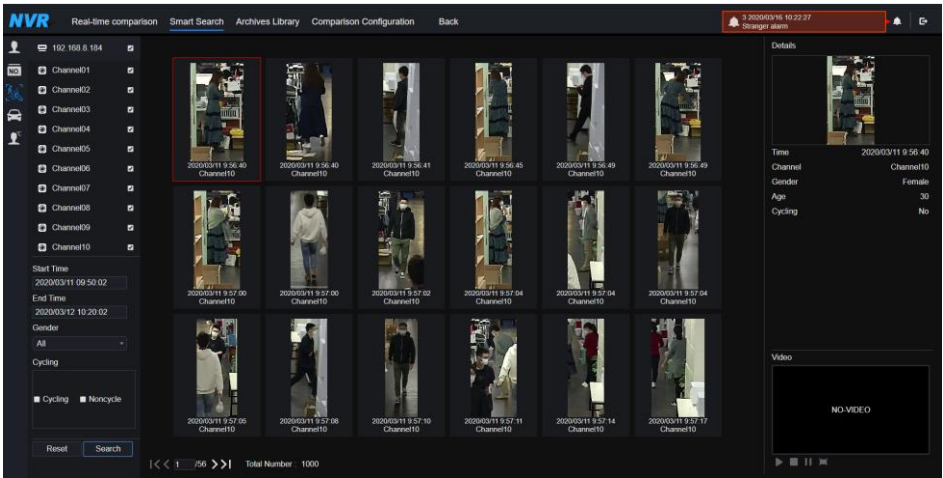

Step 1 Choose full body search at smart search interface.

Step 2 Tick the AI recognition camera channels, set the start time and end time.

Step 3 Set the gender, click cycling or no cycling .

Step 4 Click “Search” to search the snapshot of human face.

Step 5 The result will show at the middle of page, click the picture and the detail information show at the top right of page.

Step 6 Click play button of video to play the recording of snapshot.

----End

8.7.2.4 Vehicle Search

Figure 8-30 Vehicle search

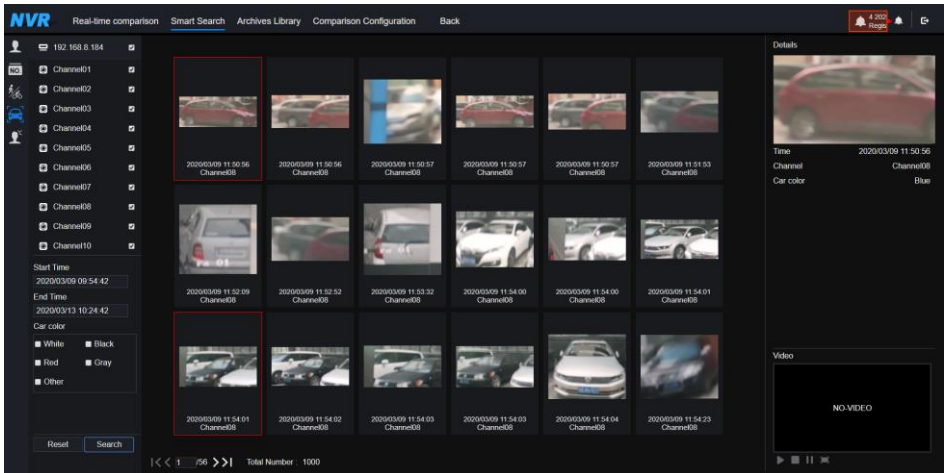

Step 1 Choose vehicle search at smart search interface.

Step 2 Tick the AI recognition camera channels, set the start time and end time.

Step 3 Tick the color.

Step 4 Click “Search” to search the snapshot of human face.

Step 5 The result will show at the middle of page, click the picture and detailed information at the top right of page.

Step 6 Click play button of video to play the recordings of snapshot.

----End

8.7.2.5 Body Temperature Search

Figure 8-31 Body temperature search

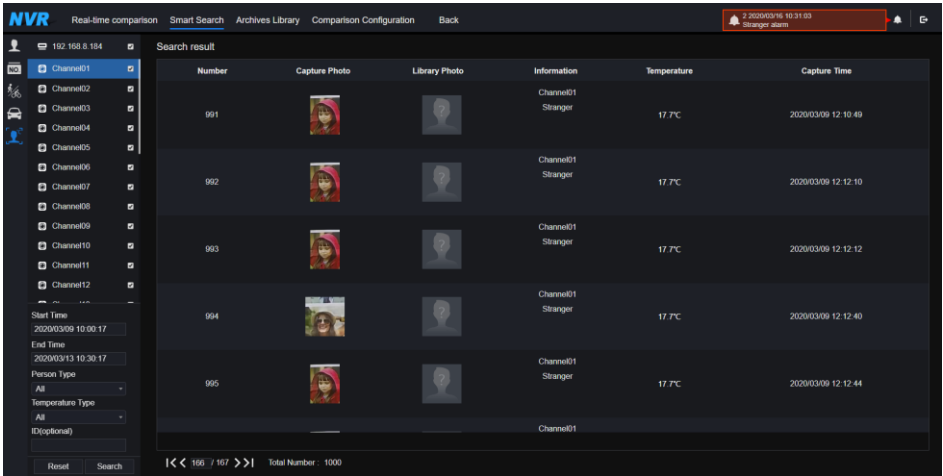

Step 1 Choose body temperature search at smart search interface.

Step 2 Tick the AI recognition camera channels, set the start time and end time.

Step 3 Choose the person type, temperature type, input ID optionally.

Step 4 Click “Search” to search the temperature.

----End

8.7.2.6 Personnel Count

If the AI camera connect to NVR, the NVR can obtain the data of camera directly. Set the statistical type (day, month, year), choose the time to search.

The result can show as line graph, histogram, or list, as shown in Figure 8-32.

Figure 8-32 Personnel count

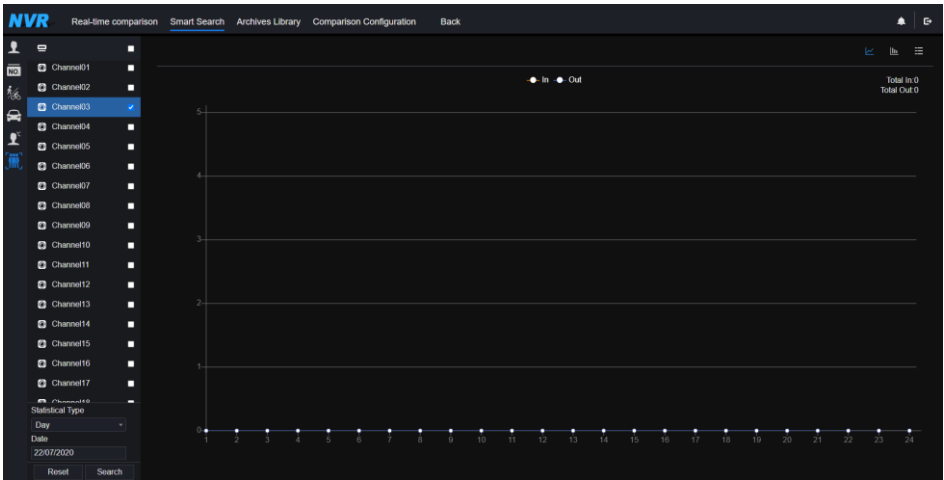

----End

8.7.3 Archives Library

At archives library, users can add or edit the face library, license plate library.

8.7.3.1 Face Library

Figure 8-33 Face library

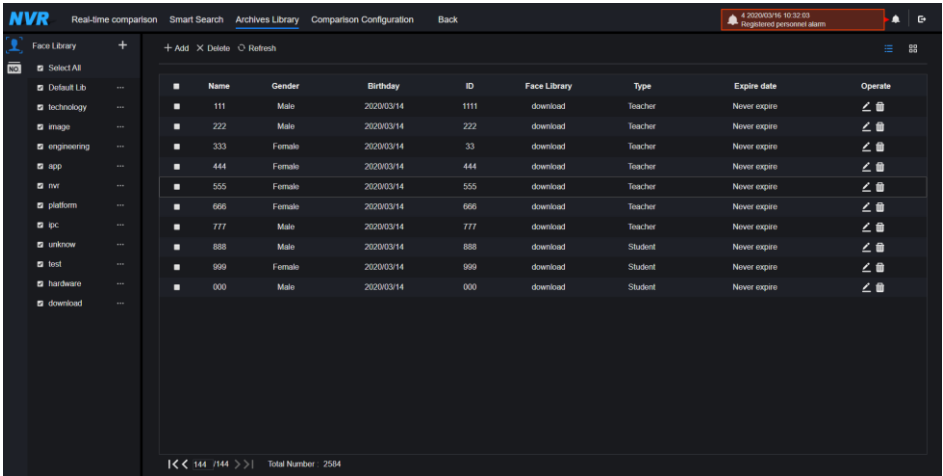

Click “+” to add face library.

Click “Add” to add person enroll.

Tick the person, click “Delete” to delete the person.

Click “Import” to add the person batch.

Click “Export” to export all people in library.

Click operate icon to edit or delete the chosen person.

To get snapshot in real time video, put the cursor on picture such as , you can add it to face library, or face search. The cursor on area 6 and the pictures are not update, move the mouse so that the pictures show in time.

---End

8.7.3.2 License Plate Library

Figure 8-34 License plate library

License Plate	License Plate Lib	Expire date	Remark	Operate
RRS05LW	EU license plate	2020/03/11 09:07:28-2020/03/11 10:00:00	1	🗑️ 🔄
RZ4316C	EU license plate	Never expire	2	🗑️ 🔄
RZE2K06	EU license plate	Never expire	4	🗑️ 🔄
RZ84375	EU license plate	Never expire	3	🗑️ 🔄
RBR44XV	EU license plate	Never expire	5	🗑️ 🔄
RZ4594F	EU license plate	Never expire	6	🗑️ 🔄
RZ49466	EU license plate	Never expire	7	🗑️ 🔄
RZ3028K	EU license plate	Never expire	8	🗑️ 🔄
RZ31033	EU license plate	Never expire	9	🗑️ 🔄
RZE4P99	EU license plate	Never expire	10	🗑️ 🔄
RP213649	EU license plate	Never expire	11	🗑️ 🔄
RZE1F02	EU license plate	Never expire	12	🗑️ 🔄
RZE9EF7	EU license plate	Never expire	13	🗑️ 🔄
RZ5615K	EU license plate	Never expire	15	🗑️ 🔄
LZ40064	EU license plate	Never expire	16	🗑️ 🔄
RLEN286	EU license plate	Never expire	18	🗑️ 🔄
RJA2925	EU license plate	Never expire	20	🗑️ 🔄

Click “+” to add license plate library.

Click “Add” to add plate to library.

Tick the plate, click “Delete” to delete the license plate.

Click “Import” to add the license plate batch.

Click “Export” to export the all-license plate library.

Click operate icon to edit or delete the chosen license plate.

----End

8.7.4 Comparison Configuration

At comparison configuration interface, users can set the comparison of human face/ license plate/temperature.

Figure 8-35 Face comparison

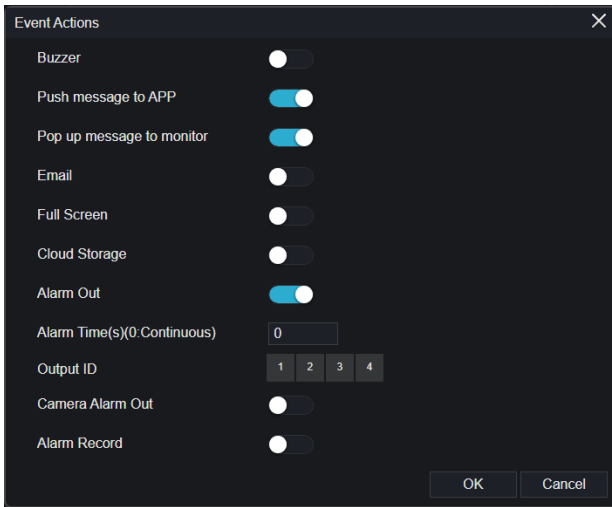
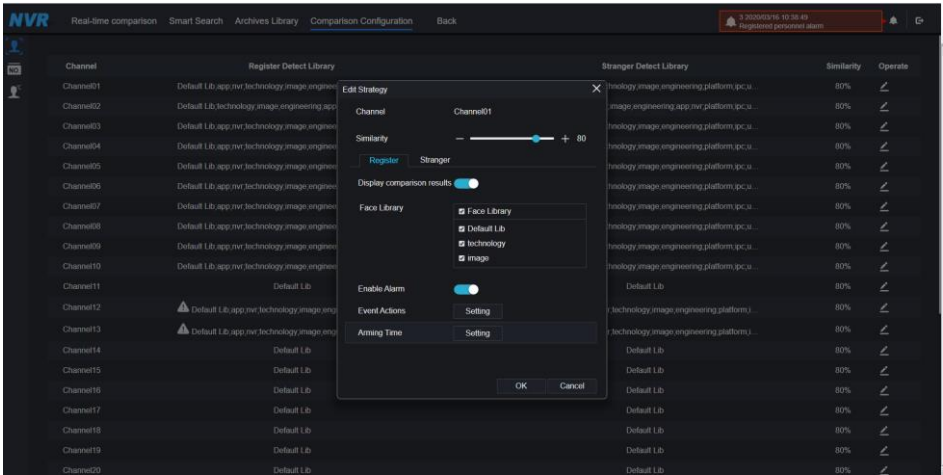

At face comparison interface, users can set different channels' strategy, such as similarity, display comparison result, face library, enable alarming, event action, schedule, as shown in Figure 6-35 .

Figure 8-36 License comparison

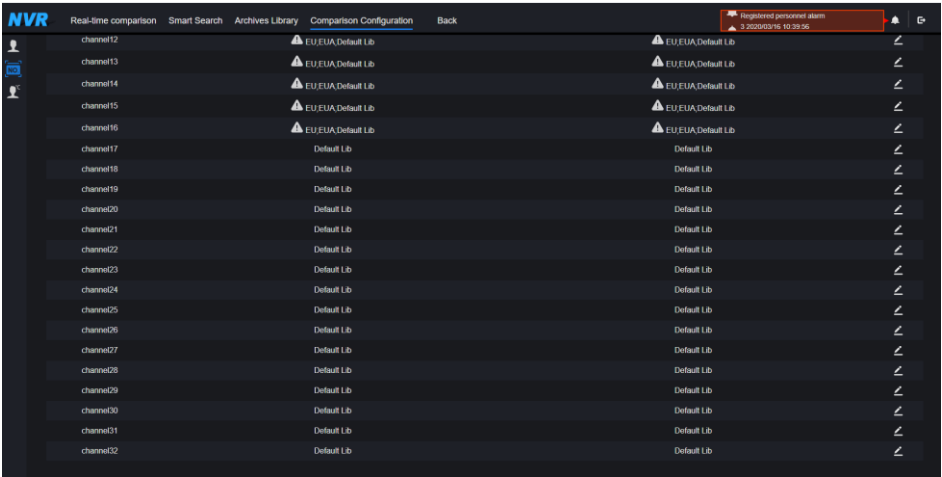

At license plate interface, users can set strategies of different channels of license plate recognition cameras, such as register and unregister, enable alarming, event action, schedule, as shown in Figure 8-36.



means the library is deleted.

Figure 8-37 Temperature comparison

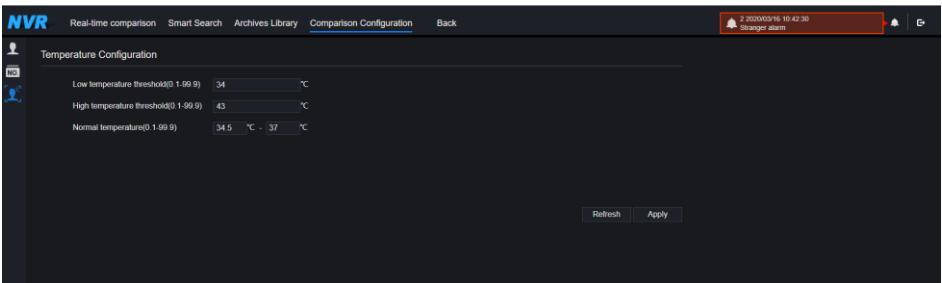

At temperature comparison interface, users can set low temperature threshold, high temperature threshold, normal temperature, as shown in Figure 8-37.

Figure 8-38 Strategy

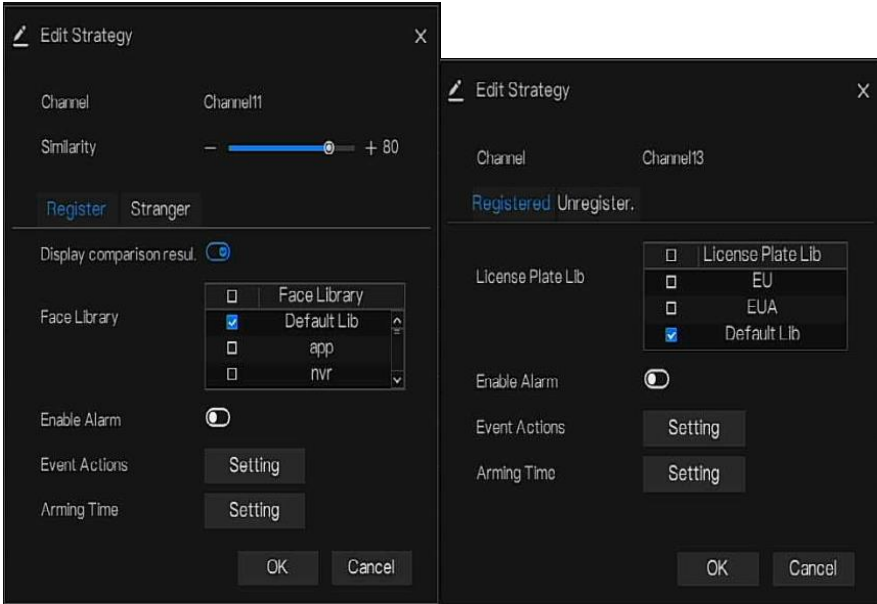

Mask detection configuration: enable mask detection, set the mode (wear mask, no mask). Set confidence degree, the default value is 90. Click “apply” to save the settings.

Figure 8-39 Mask detection configuration

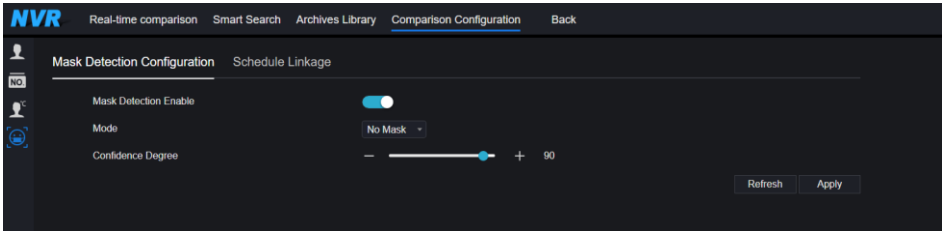

Enable mask alarm linkage, set the event action and schedule.

Figure 8-40 Schedule linkage

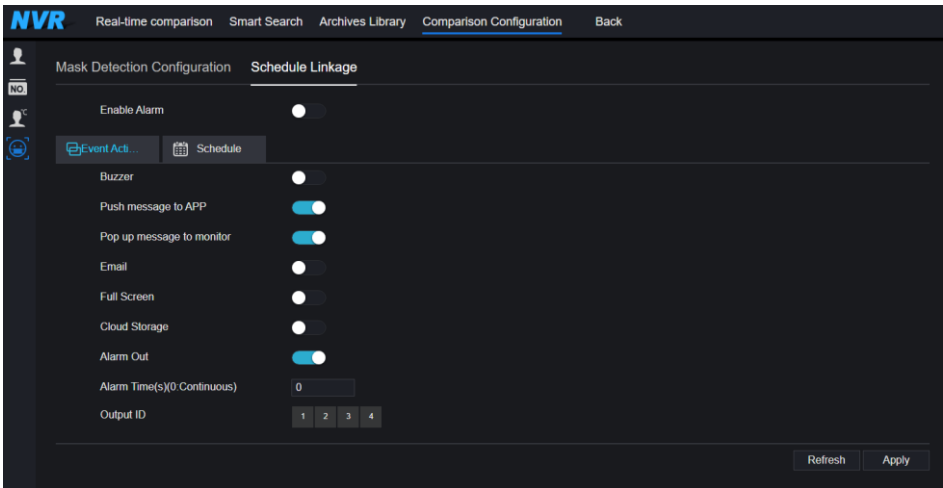

The alarm information is relevant to mask detection configuration.

----End

9 System Setting

The system setting allows you to set system, channel, record, alarm, network and local setting.

9.1 Channel

User can set parameter about camera, encode, sensor setting, OSD and privacy zone.

9.1.1 Camera

Step 0 On the **System Setting** screen, choose **Channel > Camera** to access the camera interface, as shown in Figure 9-1.

Figure 9-1 Camera interface

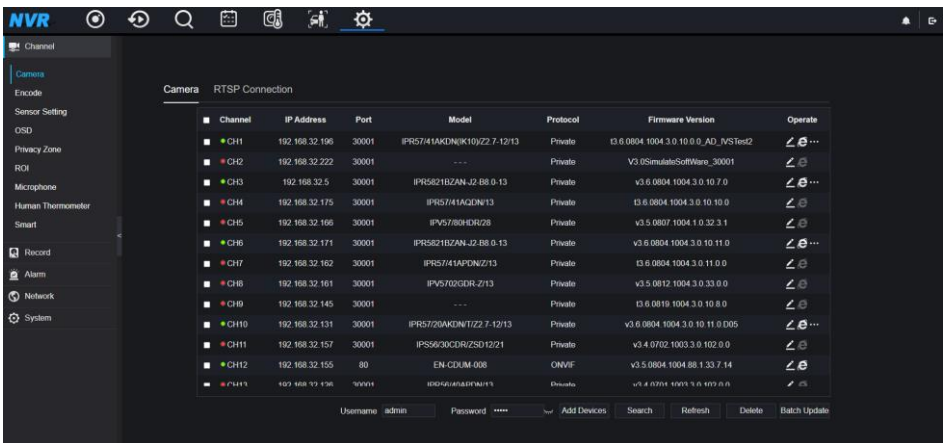

Step 1 Input username and password (the default username and password both are admin), and

click **Click To Add** add cameras automatically.

Step 2 Click **Search** to search cameras at the same LAN as NVR, as shown in Figure 9-2.

Choose the cameras, input username and password, click **Add** to add new cameras.

Figure 9-2 Device search

Camera		Protocol Management				
ID	IP Address	Port	Model	Protocol	Firmware Version	
1	192.168.99.14	30001	IP57/30BDR/ZSD30/28	Private	t3.6.0804.1004.3.0.8.12.0	
2	192.168.70.177	30001	C81031-W	Private	v3.5.0819.3900.172.0.31.0.105	
3	192.168.70.176	30001	C81041-W	Private	v3.5.0819.3900.172.0.31.0.105	
4	192.168.10.249	30044	IPR57/08ALDN/Z3.3-12/23	Private	v3.5.0819.1004.3.0.33.3.0	
5	192.168.10.208	30001	SN-T5L/13	Private	t3.6.0825.1004.3.0.13.4.0	
6	192.168.10.127	80		ONVIF	-----	
7	192.168.10.126	80		ONVIF	-----	
8	192.168.10.8	30001	SN-IPR5821BZAN-J3-Z2.7-13.5-13	Private	t3.6.0804.1004.3.0.6.90.0	

Username admin Password ●●●● Stop Search(2s) Add Refresh Back

Step 3 Click **Back** to back to camera interface.

Step 4 Click **Refresh** to refresh cameras status.

Step 5 Choose the cameras and click **Delete** to delete.

Step 6 Click **Batch Update** to update all selected cameras at once, the pop-up window would show to select software.

Step 7 Click  to modify the information of device parameters, as shown in Figure 9-3.

Figure 9-3 Modify device parameters

Modify device parameters

Channel Name: Channel06

IP Address: 192.168.0.232

Protocol: Private_SSL

Port: 20001

Username: admin

Password:

Remote Channel: CH-1

Buttons: Cancel, OK

Step 8 Click  to add camera manually, click the added channel to copy information to add, so that user just modify some information quickly, as shown in Figure 9-4.

Figure 9-4 Add camera manually

Manually Add Devices

Channel	IP	Protocol
CH1	192.168.32.196:30001	Private
CH2	192.168.32.222:30001	Private
CH3	192.168.32.5:30001	Private
CH4	192.168.32.175:30001	Private

Channel: 32

IP Address: 192.168.32.5

Protocol: Private

Port: 30001

Username: admin

Password:

Remote Channel: CH-1

Buttons: OK, Cancel

Step 9 Click  to access web immediately.

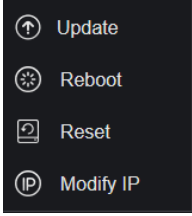
Step 10 Click  to update, reboot or reset the selected camera, as  shows.

The pop-up message “Are you sure to restart the device?” “Are you sure to reset? Reserve IP Address” would respectively show.

Figure 9-5 Modify IP

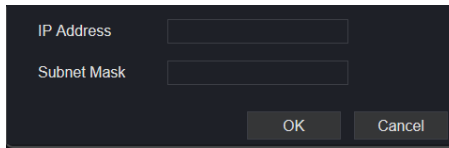

 **NOTE**



: it indicates the camera is online, users can view the live video immediately.



: it indicates the camera is offline, it maybe not connected to the network, or the password is incorrect. Access to the modify device parameters interface to change.

9.1.1.1 Protocol Management

Set the protocol management, users can add different protocol cameras to NVR

Figure 9-6 Protocol management

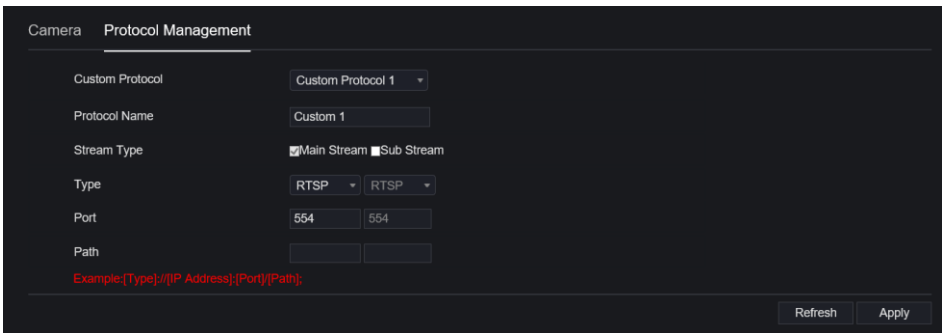

Step 1 Click **Channel > Camera > RTSP Connection**.

Step 2 Choose the custom protocol from the drop-down list, there are 16 kinds of protocols can be set.

Step 3 Input the protocol name.

Step 4 Tick main stream and sub stream. The main stream shows image on full screen live video.

The sub stream shows image on split screen. If you just tick main stream and the channel will not show image on split screen.

Step 5 Choose the type of protocol, the default value is RTSP.

Step 6 Input the port of the IP camera.

Step 7 Input the path, which decided by the manufacturer of cameras.

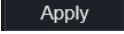
Step 8 Click  to save the settings.

9.1.2 Encode

Step 1 On the **System Setting** screen, choose **Channel > Encode** to access the encode interface, as shown in Figure 9-7.

Figure 9-7 Encode interface

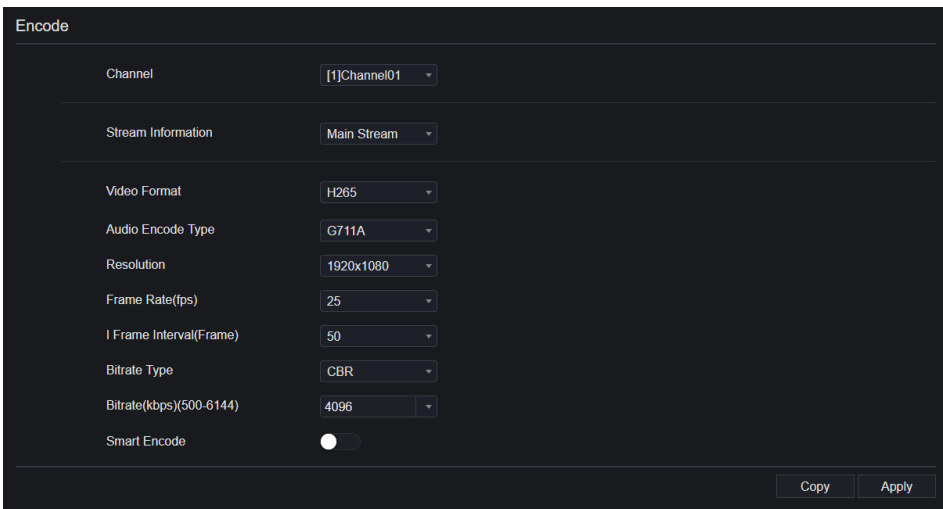

Step 2 Select a channel from drop-down list.

Step 3 Select stream information, encode type, resolution, frame rate, bitrate control and bitrate from drop-down list.

Step 4 Click **Copy** to choose other camera to copy settings. Click **Apply** to save the settings.

----End

9.1.3 Sensor Setting

Step 1 On the **System Setting** screen, choose **Channel >Sensor Setting** to access the sensor setting interface, as shown in Figure 9-8.

Figure 9-8 Image interface

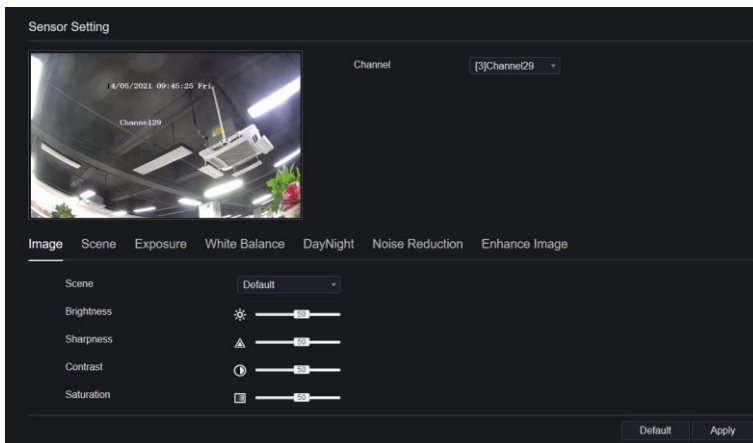

Step 2 Select a channel and scene from drop-down list.

Step 3 Set image parameters, like scene, brightness, sharpness, contrast and saturation.

Step 4 Other parameters are camera's sensor setting, please refer IP cameras' settings.

Step 5 Click **Copy** to choose other cameras to copy settings. Click **Apply** to save the settings.

 **NOTE**

Brightness: It indicates the total brightness of an image. As the value increases, the image becomes brighter.

Sharpness: It indicates the border sharpness of an image. As the value increases, the borders become clearer, and the number of noise points increases.

Saturation: It indicates the color saturation of an image. As the value increases, the image becomes more colorful.

Contrast: It indicates the measurement of different brightness levels between the brightest white and darkest black in an image. The larger the difference range is, the greater the contrast is the smaller the difference range is, the smaller the contrast is.

Scene: it includes indoor, outdoor, default. Mirror includes normal, horizontal, vertical, horizontal + vertical.

Exposure: it includes mode, max shutter, meter area and max gain.

White balance: it includes tungsten, fluorescent, daylight, shadow, manual, etc.

Day-night: it transit day to night, or switch mode.

Noise reduction: it includes 2D NR and 3D NR.

Enhance image: it includes WDR, HLC, BLC, defog and anti-shake.

Zoom focus: zoom and focus.

----End

9.1.4 OSD

Step 1 On the **System Setting** screen, choose **Channel >OSD** to access the OSD interface, as shown in Figure 5-4

Figure 9-9 OSD interface

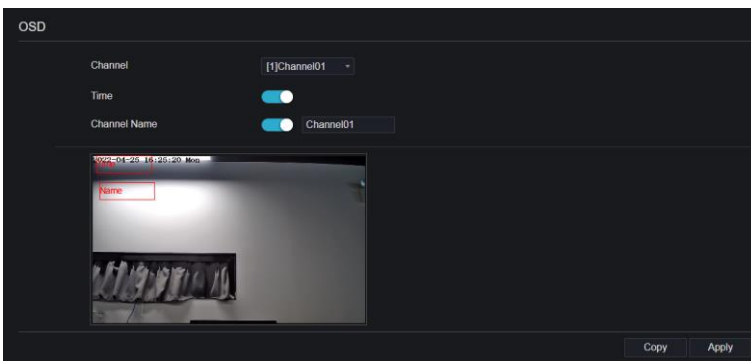

Step 2 Select a channel and scene from drop down list.

Step 3 Enable time and channel name. You can set channel name. Drag the icon of Channel Name or Date and Time to move, select the location.

Step 4 Click **Copy** to choose other cameras to copy settings. Click **Apply** to save the settings.

----End

9.1.5 Privacy Zone

Step 1 On the **System Setting** screen, choose **Channel >Privacy Zone** to access the privacy zone interface, as shown in Figure 9-10.

Figure 9-10 Privacy interface

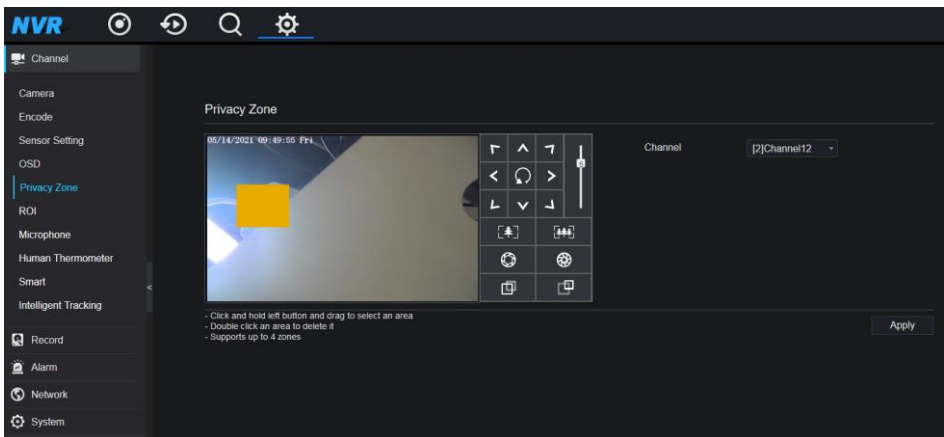

Step 2 Select a channel from drop-down list.

Step 3 Drag the mouse to select area to cover with rectangle frame. You can set less than four areas to be covered. Double click would delete the area.

Step 4 PTZ can be used for adjusting the IP dome cameras.

Step 5 Click **Copy** to choose other cameras to copy settings. Click **Apply** to save the settings.

----End

9.1.6 ROI

ROI(Region of interest), choose channel, stream, area ID and draw the area. Set the level, there are five levels can be chosen. Set area name, click “Apply” to save the settings.

Figure 9-11 ROI

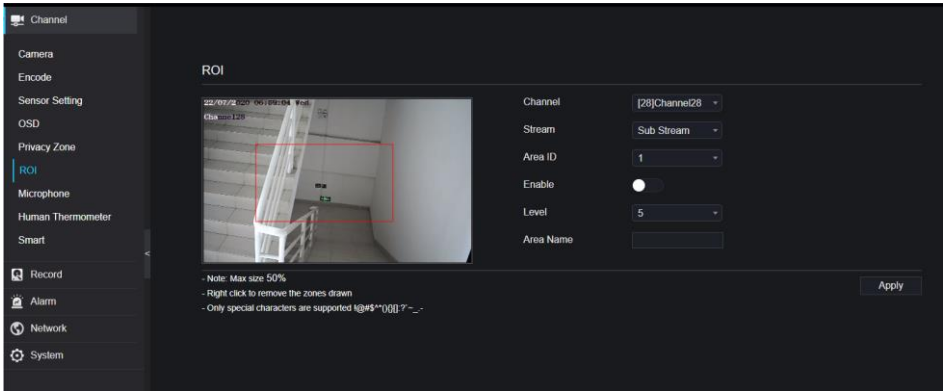

9.1.7 Microphone (Only for Some Models)

Users can set the microphone parameters of channel.

Figure 9-12 Microphone

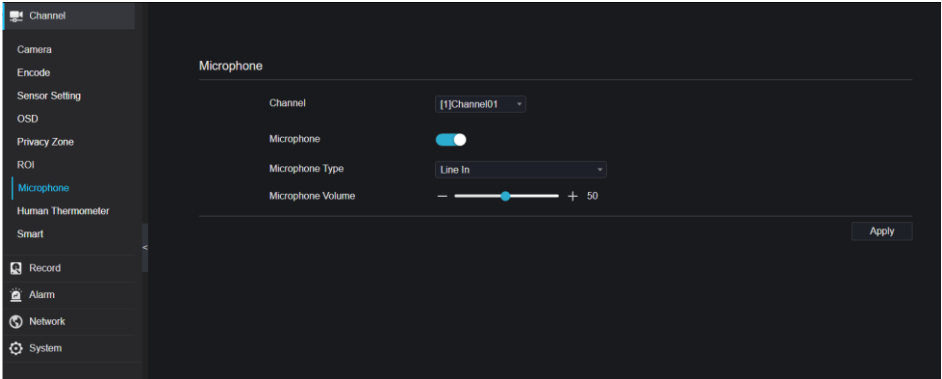

9.1.8 Human Thermometer (Only for Some Models)

Users can set the parameters of human thermometer cameras, such as parameter configure, thermal mapping, thermal calibration, for more detail please refer to the UI settings.

Figure 9-13 Human thermometer

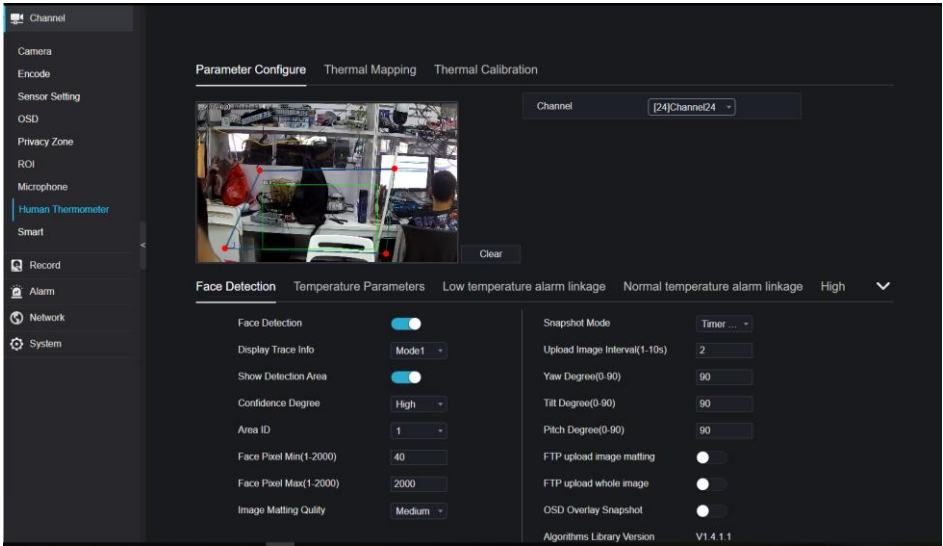

9.1.9 Smart (Only for Some Models)

At smart interface, users can set AI multiobject, license plate recognition, face detection.

Figure 9-14 Smart interface

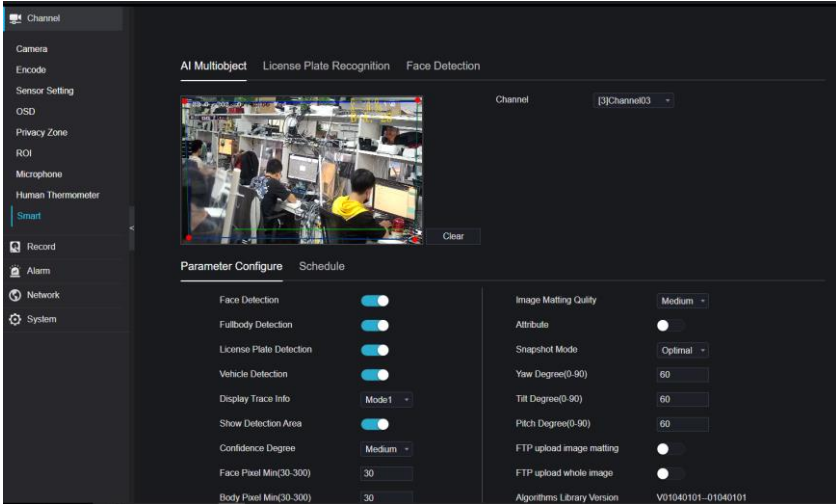

9.1.10 Intelligent Tracking (Only for Some Models)

This function can only be used for high speed dome camera. It works with PTZ function.

Figure 9-15 Intelligent tracking

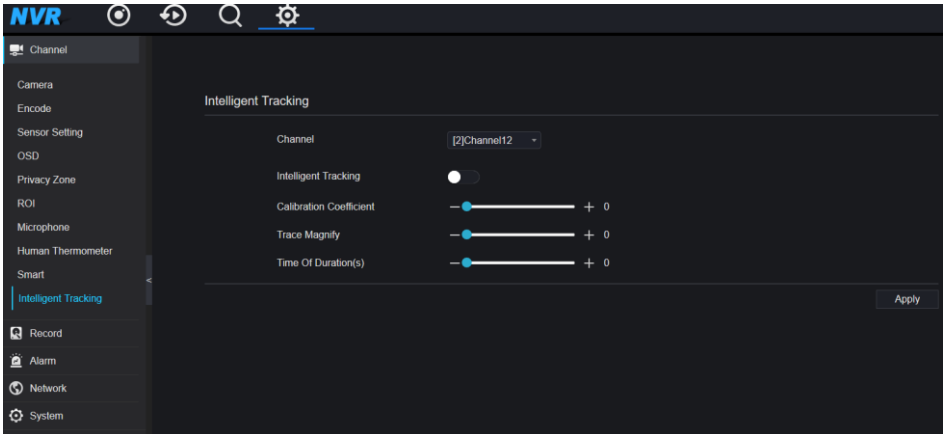

The detailed information please refer to UI configuration setting.

9.2 Record

Users can set record policy in storage interface.

9.2.1 Record Schedule

Procedure

Step 1 On the **System Setting** screen, choose **Record > Record schedule** to access the record schedule interface, as shown in Figure 9-16.

Figure 9-16 Record schedule interface

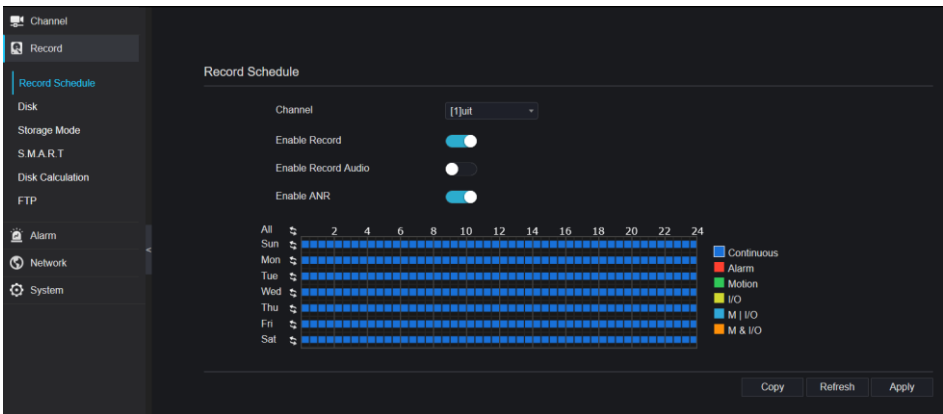

Step 2 Select a channel.

Step 3 Enable the record, then enable record audio.

Step 4 Enable ANR, when the IP cameras support the ANR, if the cameras are disconnected to NVR, the NVR can copy the loss video recordings from SD card installed in cameras.

Step 5 Set the record schedule, you can drag the mouse to choose area, click  to choose all day or all week, you can also click one by one to set the schedule. Or dray the mouse cursor to choose. Users can set the alarm recording to save the space of disk.

Step 6 Click  to return the previous settings.

Step 7 Click **Copy** to choose other cameras to copy settings. Click **Apply** to save the settings.

----End

9.2.2 Disk

Step 1 On the **System Setting** screen, choose **Record >Disk** to access the disk interface, as shown in Figure 9-17.

Figure 9-17 Disk interface

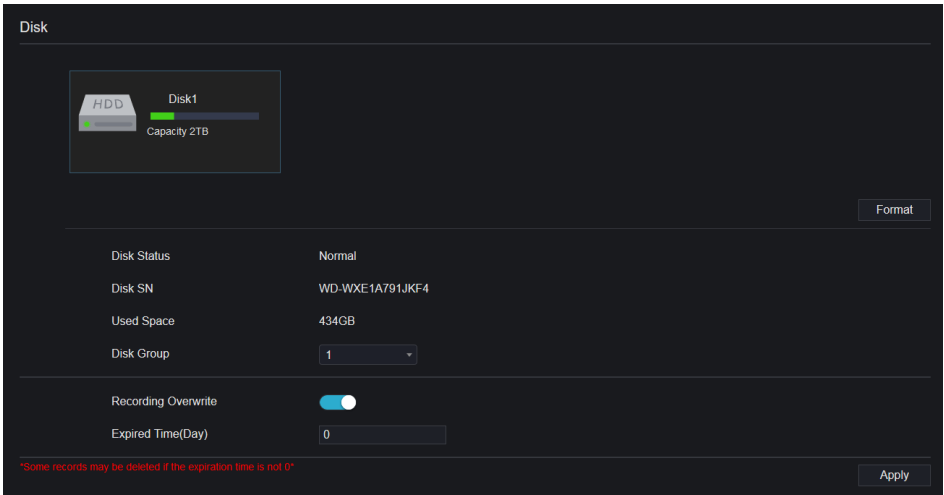

Step 2 You can view the information like capacity, disk status, disk SN code and used space.

Step 3 Click **Format** to delete all data. Before deleting data users will view pop-up window

“Are you sure to format disk? Your data will be lost”. Click **OK** to delete, click

Cancel to quit.

Step 4 Choose the disk group from drop-down list, there are four disk groups.

Step 5 Enable the recording overwrite, set the expired time. (If the expired time is 0, it means the disk is full, then the recording will be rewrite. If the expired time is 5 days, the recording video will be rewrite when it reaches the expiration date..)

Step 6 If the recording overwrite is disable, set the expired time, it is up to 90 days.

----End

9.2.3 Storage Mode

Distribute channels to different disk groups as needed for efficient use of the disk capacity.

Figure 9-18 Storage Mode

The screenshot displays the 'Storage Mode' configuration page. At the top, 'Mode Selection' has 'Group' selected. Below it, 'Disk Group' is set to '1'. The 'Channel' section shows a grid of 16 channels (1-16) assigned to Group 1. A table at the bottom provides details for four disk groups:

Group	Disk	Channel	Used Space	Capacity
1	Disk1	1-16	985GB	1000GB
2	Disk2	17-32	733GB	4.0TB
3	Disk3	33-48	753GB	4.0TB
4	Disk4	49-64	2.9TB	3.0TB

Operation Steps

Step 1 Choose the disk group.

Step 2 Select the channel to record to disk group.

Step 3 Click Apply to save the settings.

Step 4 The group list will show the detail information.

9.2.4 RAID (Only for Some Models)

NOTE

RAID is only used for the device with 4 disks or more. And the disks must be enterprise level disks. It is recommended to choose the same capacity for efficient use.

For Raid5, at least 3 disks can be created. For RAID6, at least 4 disks can be created. For RAID10, at least 4 disks can be created. Creating a hot spare disk requires more disks.

It is recommended to choose the same capacity for efficient use. The RAID with less than 100T capacity can be built.

Figure 9-19 RAID

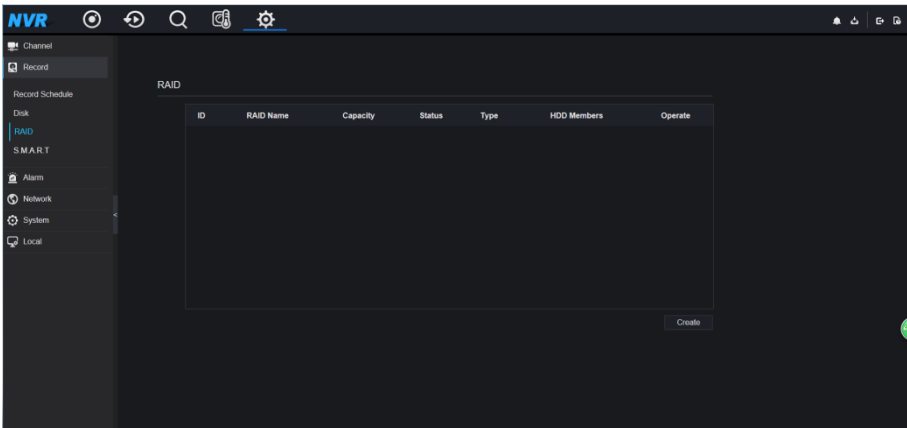

Operation Steps

Step 1 Click **RAID** to create the RAID.

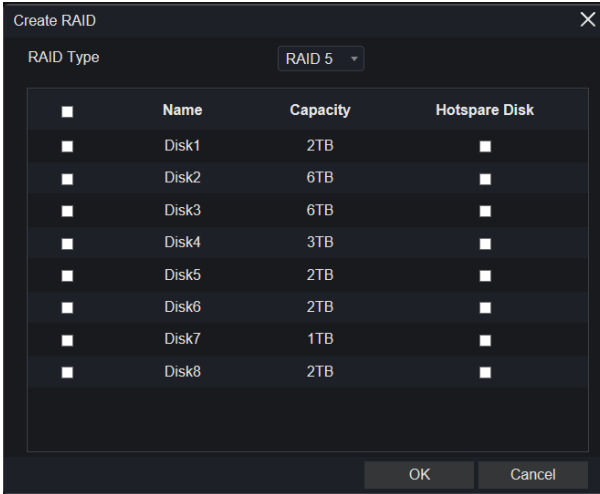

Step 2 Click **Create** to choose disk to create a new RAID.

Step 3 Tick the **Hot-spare Disk** to back up the broken disk in case, the number of disk must be more than basic disks.

Step 4 Click  to save the operation, format the new RAID

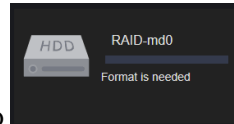

Step 5 Click **format it will show**

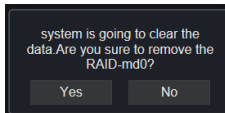
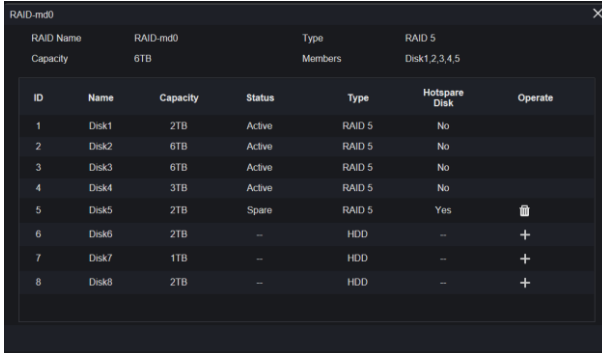

Figure 9-20 Modify the RAID



9.2.5 S.M.A.R.T

S.M.A.R.T is Self-Monitoring Analysis and Reporting Technology, users can view the health of disk, as shown in Figure 9-21.

Figure 9-21 S.M.A.R.T

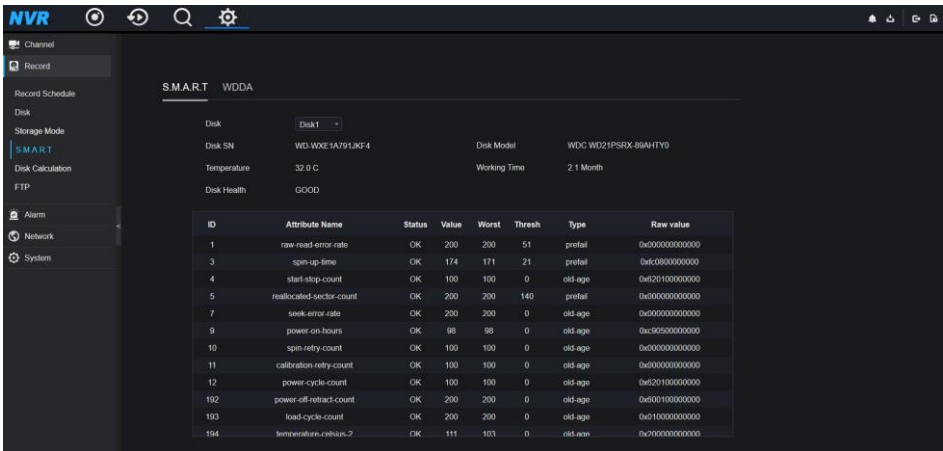

The disk of Western Digital can be viewed by WDDA, as shown in Figure 9-22.

Figure 9-22 WDDA (Supplied for Some Model)

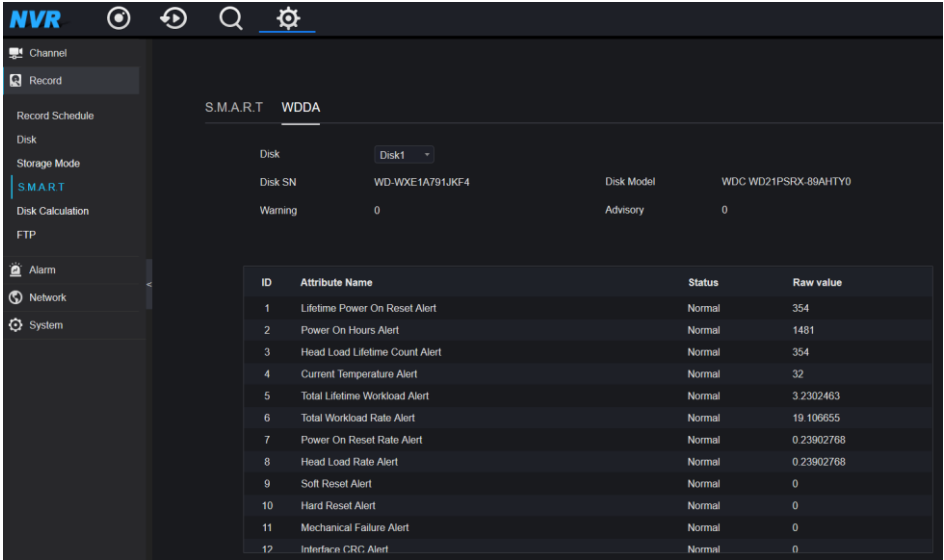

9.2.6 Disk Calculation

Computing Capacity
Computation time

There are two modes to calculate the captivity of disk, as shown in.

Figure 9-23 Disk calculation

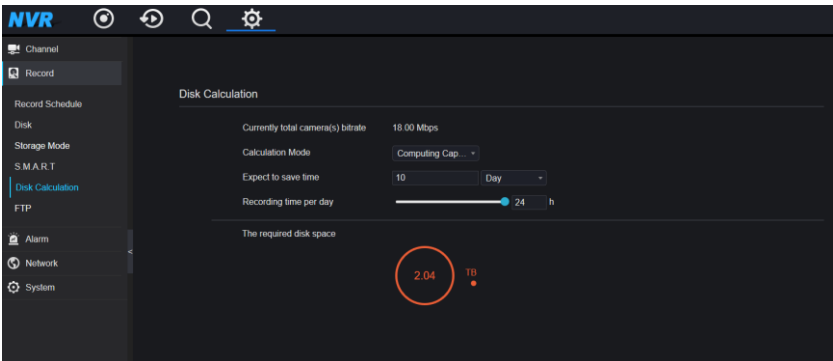



9.2.7 Cloud Storage (Only for Some Models)

User copy the authorization code path to browser to enter Google Drive interface. Google sends the code, and users input the code to authority NVR, so the device can set the alarm recording to Google drive.

Figure 9-24 Cloud Storage

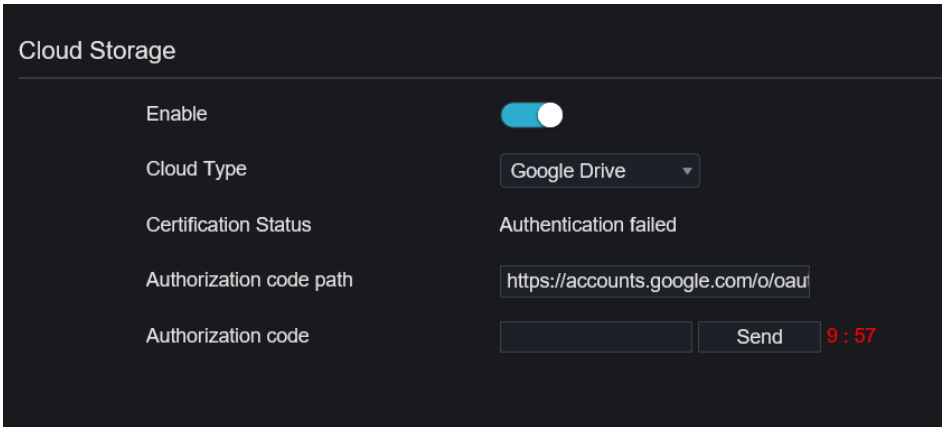

 **NOTE**

Enable the alarm of cloud storage at first so that the Google drive can receive the recoding.
Cloud storage can only be set at motion detection and intelligent analysis interface.

9.2.8 FTP

Set the FTP path to receive the alarm information, as shown in Figure 9-25. More detail information please refer to UI interface parameters.

Figure 9-25 FTP

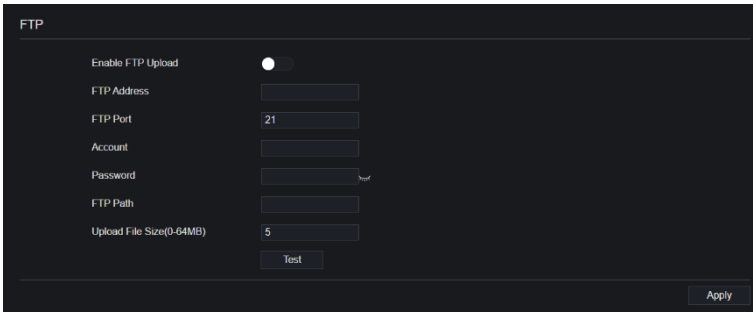

9.3 Alarm

Users can set general, motion detection, video loss, intelligent analysis and alarm in on alarm interface.

9.3.1 General

9.3.1.1 General

Procedure

Step 1 On the **System Setting** screen, choose **Alarm > General** to access the general interface.

Step 2 Enable alarm to set duration time and buzzer duration time, as shown in Figure 9-26.

Figure 9-26 General interface

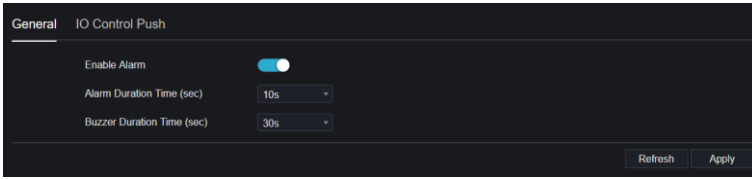

Step 3 Click **Apply** to save settings. Click **Refresh** to return to the previous settings.

9.3.1.2 IO Control Push

Procedure

Step 1 On the **System Setting** screen, choose **Alarm > General > IO Control Push** to access the general interface.

Step 2 Enable the IO control push, as shown in Figure 9-27.

Figure 9-27 IO control push interface

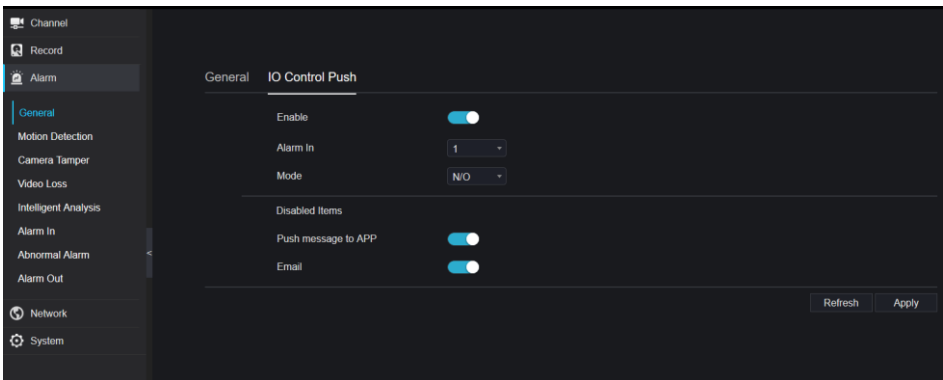

Step 3 Choose one alarm in and mode (N/C, N/O).

Step 4 Tick the disable items, click “Apply” to save settings.

----End

9.3.2 Motion Detection

Procedure

Step 1 On the **System Setting** screen, choose **Alarm > Motion Detection** to access the motion detection interface, as shown in Figure 9-28.

Figure 9-28 Motion detection interface

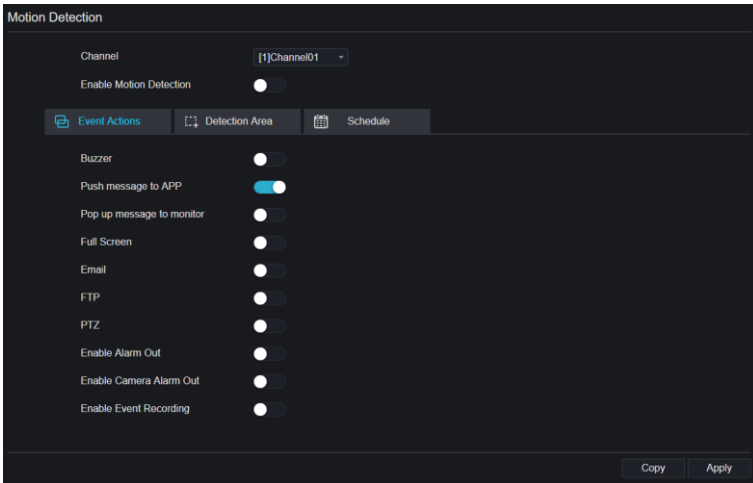

Step 2 Click channel drop-down list to choose channel.

Step 3 Enable motion detection alarm.

Step 4 Set **Event Activity**, includes buzzer, push message to APP, pop-up message to monitor, full screen, Email, cloud storage, alarm out (the back panel), channel alarm out (the port of cameras), and alarm record.

Step 5 Click **Area** to access the motion detection area setting, as shown in Figure 9-29.

Figure 9-29 Motion detection area interface

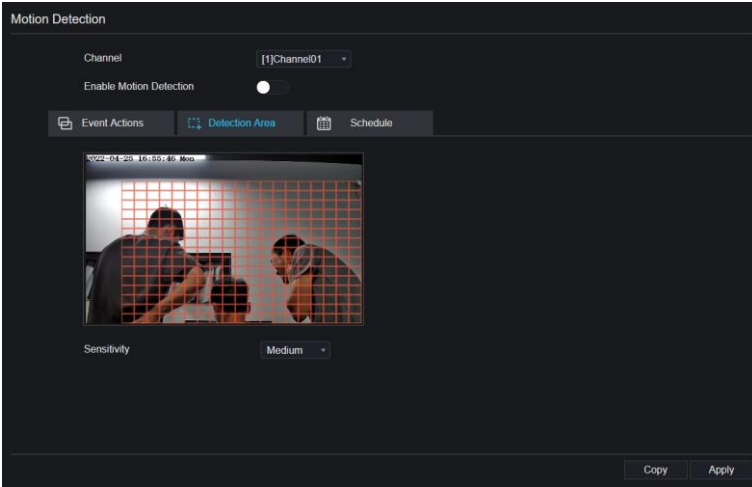

1. Hold down and drag the left mouse button to draw a motion detection area.
2. Select a value from the drop-down list next to **Sensitivity**.
3. Double-click the chosen area to delete.

Step 6 Click **Schedule** to access schedule settings, drag and release mouse to select the alarming time within 00:00-24:00 from Monday to Sunday. Click the chosen area can cancel. The settings of alarm schedule are same as disk schedule.

Step 7 Click **Copy** to choose other cameras to copy settings. Click **Apply** to save the settings.

---End

9.3.3 Video Loss

Procedure

Step 1 On the **System Setting** screen, choose **Alarm > Video Loss** to access the video loss interface, as shown in Figure 9-30.

Figure 9-30 Video loss interface

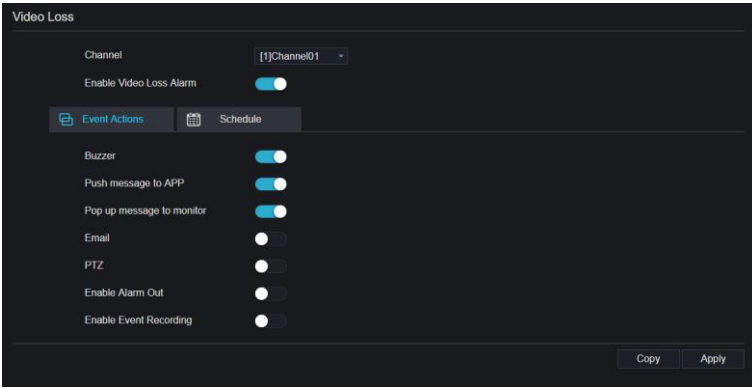

Step 2 Click drop-down list to choose channel.

Step 3 Enable the video loss alarm.

Step 4 Set event activity and schedule please refer to *Figure 5-1 motion detection settings*.

Step 5 Click **Copy** to choose other camera to copy settings. Click **Apply** to save the settings.

----End

9.3.4 Advanced intelligent Analysis (Only for Some Models)

Users can set smoker detection, smoke and flame detection and fire spot detection at advanced intelligent analysis interface.

Figure 9-31 Smoker Detection

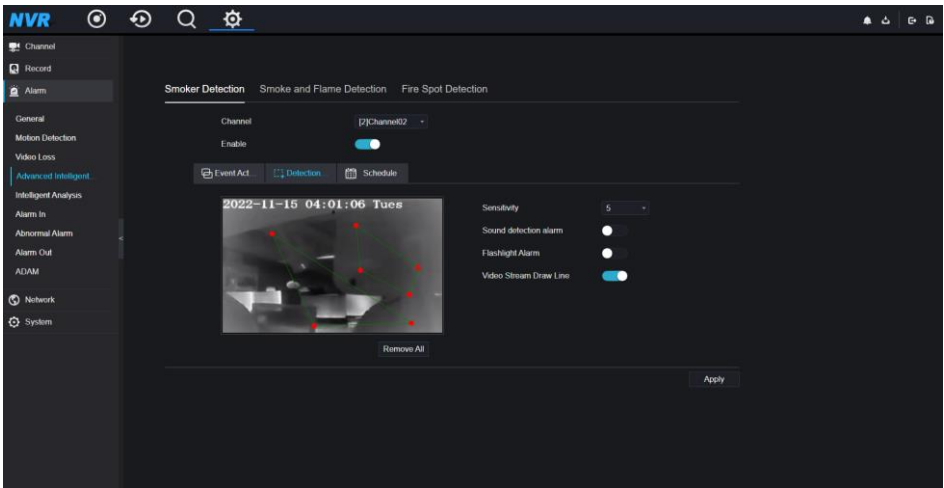
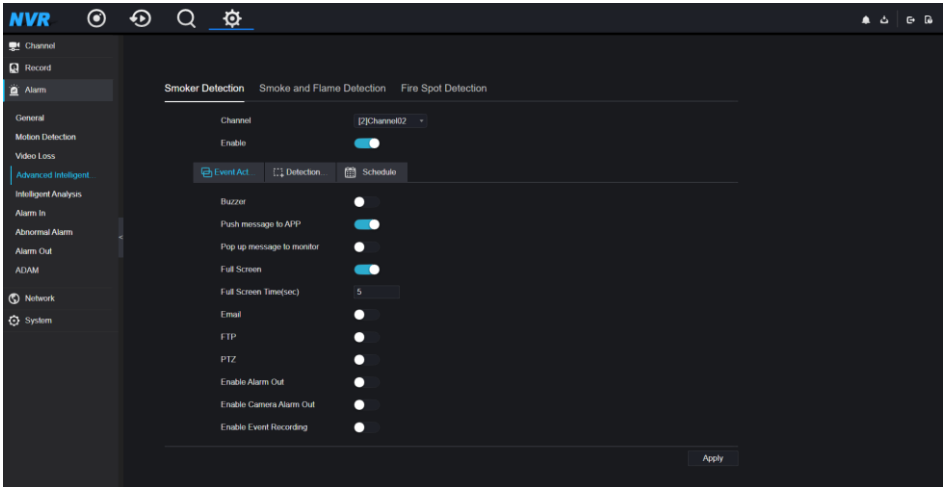

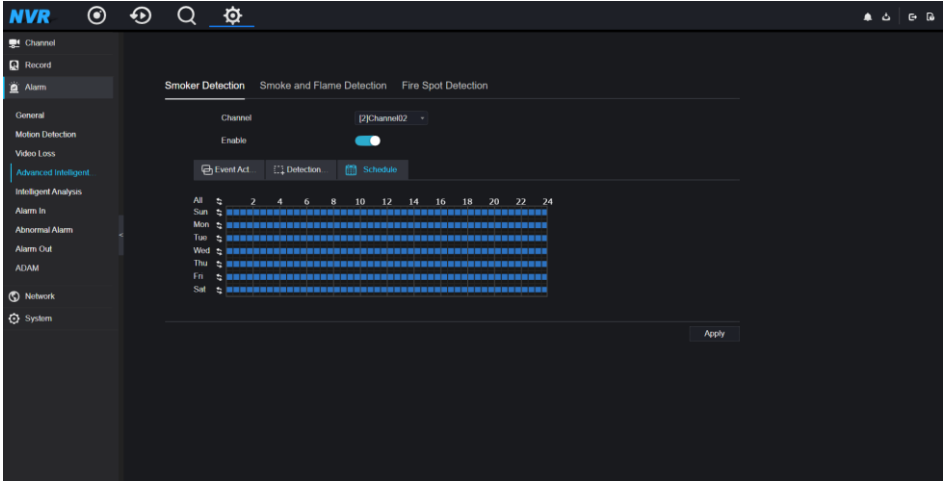
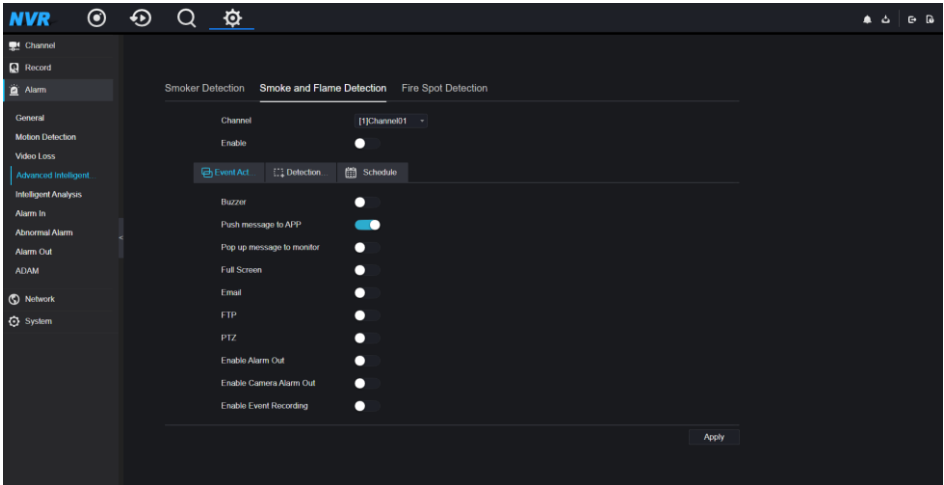

Figure 9-32 Smoke and flame detection



Smoker Detection **Smoke and Flame Detection** Fire Spot Detection

Channel [1]Channel01

Enable

Event Act... Detection... Schedule

2022-11-15 04:01:48 Tues



Remove All

Sensitivity 5

Sound detection alarm

Flashlight Alarm

Video Stream Draw Line

Apply

Smoker Detection **Smoke and Flame Detection** Fire Spot Detection

Channel [1]Channel01

Enable

Event Act... Detection... Schedule

All	2	4	6	8	10	12	14	16	18	20	22	24
Sun	☑	☑	☑	☑	☑	☑	☑	☑	☑	☑	☑	☑
Mon	☑	☑	☑	☑	☑	☑	☑	☑	☑	☑	☑	☑
Tue	☑	☑	☑	☑	☑	☑	☑	☑	☑	☑	☑	☑
Wed	☑	☑	☑	☑	☑	☑	☑	☑	☑	☑	☑	☑
Thu	☑	☑	☑	☑	☑	☑	☑	☑	☑	☑	☑	☑
Fri	☑	☑	☑	☑	☑	☑	☑	☑	☑	☑	☑	☑
Sat	☑	☑	☑	☑	☑	☑	☑	☑	☑	☑	☑	☑

Apply

Figure 9-33 Fire spot detection

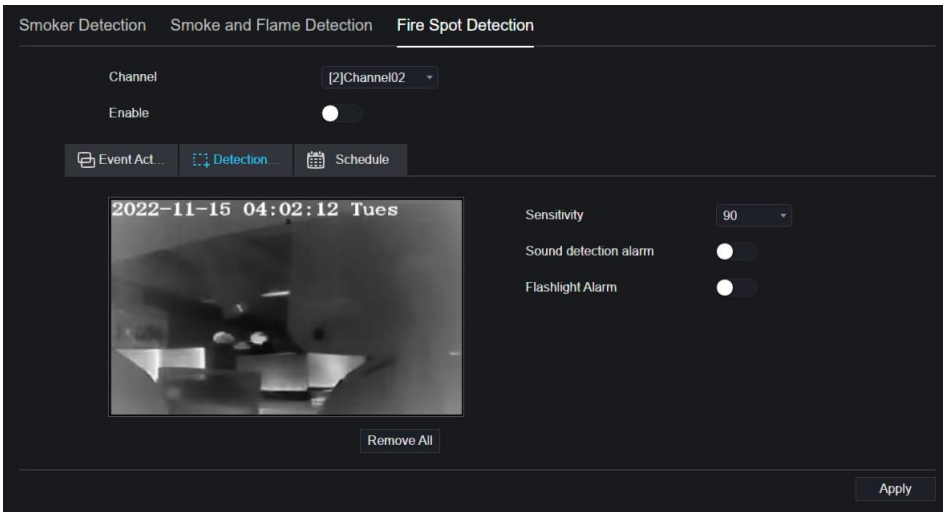
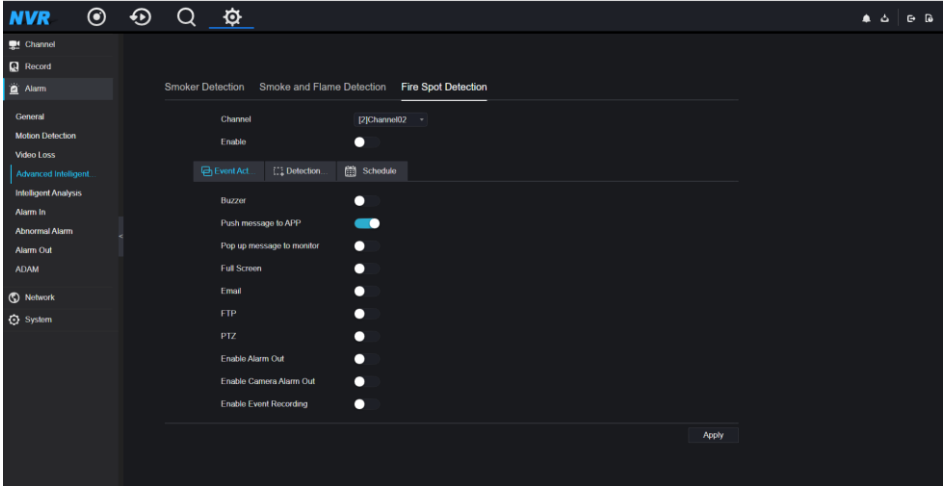

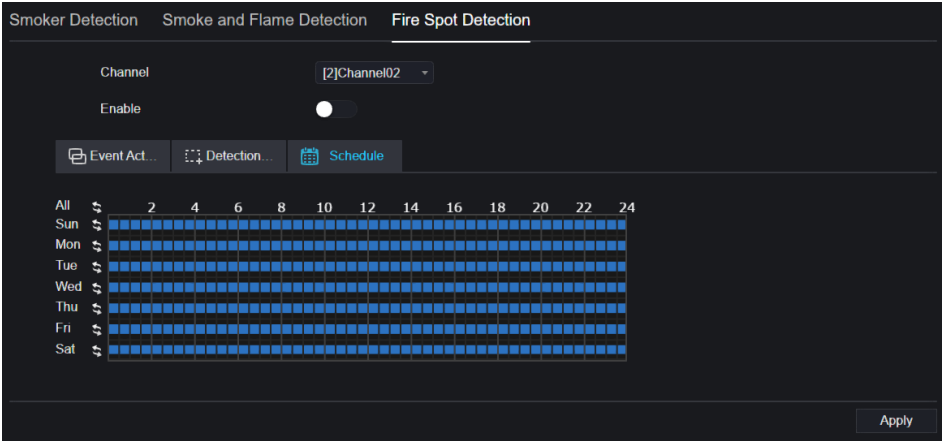

9.3.5 Intelligent Analysis (Only for Some Models)

Procedure

Please refer to chapter 7.4.1 *video loss settings*, interface displayed as shown in Figure 9-34.

Figure 9-34 Intelligent analysis interface

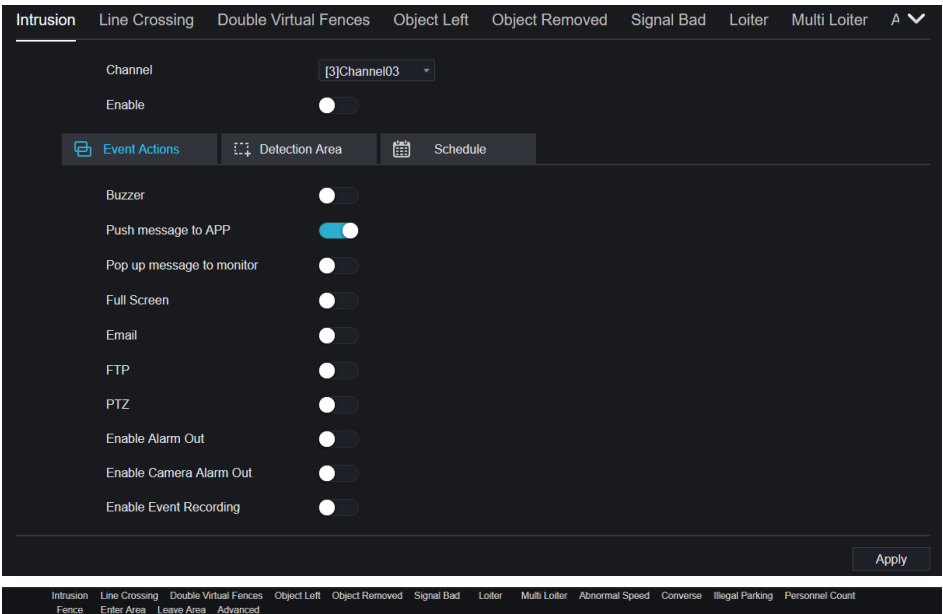

9.3.6 Alarm In

Procedure

Step 1 On the **System Setting** screen, choose **Alarm > Alarm In** to access the alarm in interface, as shown in Figure 9-35.

Figure 9-35 Alarm in interface

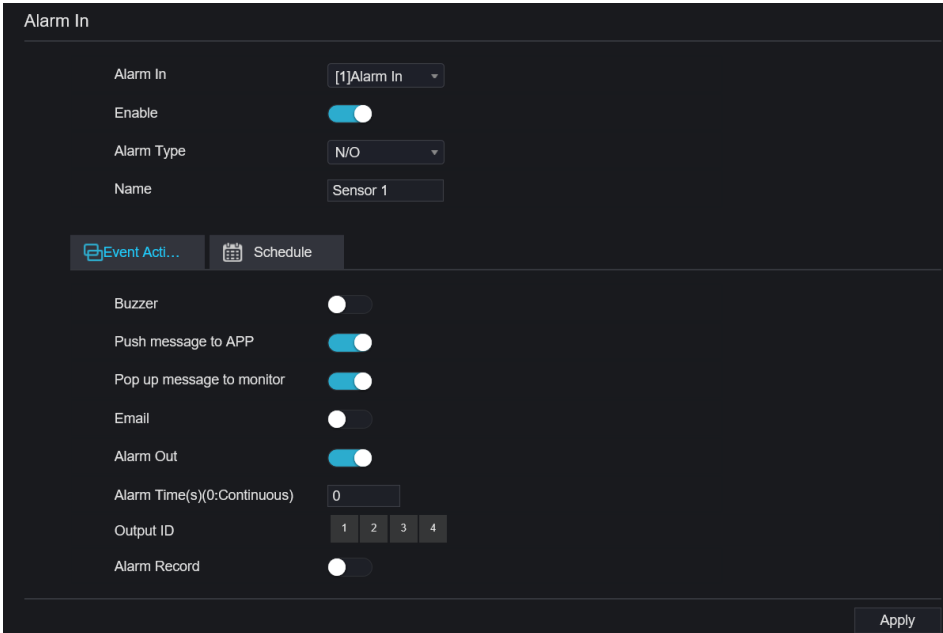

Step 2 Click drop-down list to choose alarm in.

Step 3 Enable the button, choose alarm type.

Step 4 Set name, default as Sensor 1.

Step 5 Set event activity and schedule please refer to *motion detection settings*.

Step 6 Click **Apply** to save settings.

----End

9.3.7 Abnormal Alarm

Procedure

Step 1 On the **System Setting** screen, choose **Alarm > Abnormal Alarm** to access the abnormal alarm interface, as shown in Figure 6-12.

Figure 9-36 Abnormal alarm interface

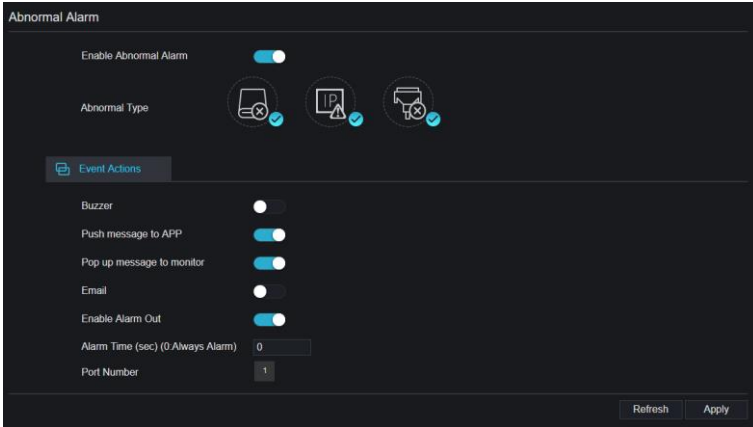

Step 2 Enable the button, tick alarm type.

Step 3 Set event activity and schedule please refer to *motion detection settings*.

Step 4 Click **Apply** to save settings.

----End

9.3.8 Alarm out

Set the alarm out, the camera alarm out.

Figure 9-37 Alarm out

Alarm Out	
Camera Alarm Out	
Port Number	[1]Alarm Out
Port Name	
Valid Signal	Close
Alarm Output Mode	Switch Mode

Refresh Apply

Figure 9-38 Camera alarm out

Alarm Out	
Camera Alarm Out	
Channel	[1]Channel01
Port Number	1
Port Name	
Valid Signal	Close
Alarm Output Mode	Switch Mode
Alarm Time(ms)(0 Continuous)	0

Refresh Apply

9.3.9 ADAM

If users want to receive the alarm information at remote distance, you can access the ADAM data acquisition modules to NVR for alarming.

Several ADAM data acquisition modules can be accessed to NVR. The maximum number support of ADAM is the number of channels of NVR supporting.

Figure 9-39 ADAM

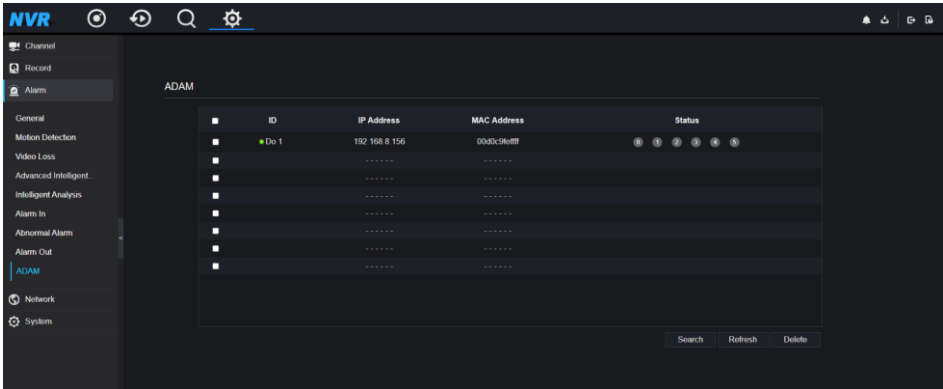

The ADAM is connected to the network which are same segment with NVR's.

Click Search to search the ADAM, click Add to add the online ADAM to list.

When you enable the Remote IO linkage action, choose the corresponded ID (remote channel) and port (the ID of alarm device accessed to ADAM) depend on the actual scene.

9.4 Network

Users can set Network, DDNS, E-mail, UPnP, P2P, IP Filter, 802.1X, SNMP and Web Mode.

9.4.1 Network

Procedure

Step 1 On the **System Setting** screen, choose **Network > Network** to access the network interface, as shown in Figure 9-40.

Figure 9-40 Network interface

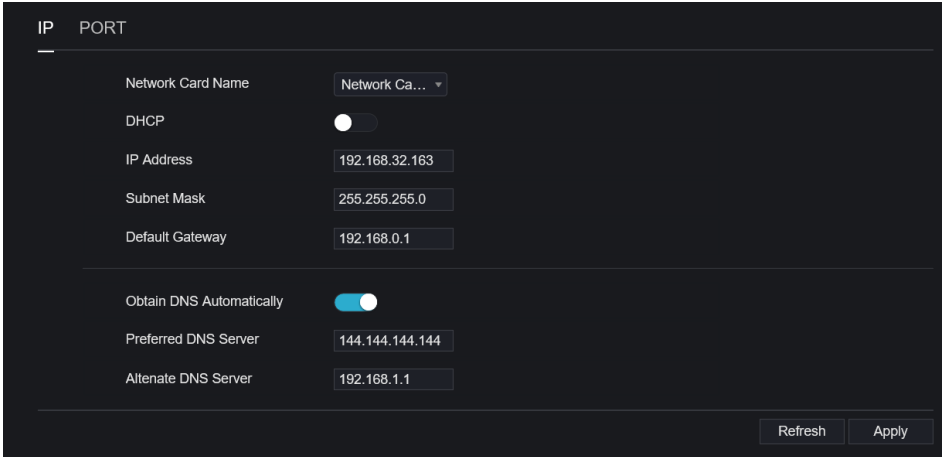

Step 2 Choose network card from the drop-down list. Network card I is LAN1, network card II is LAN2, as shown in Figure 9-41.

Figure 9-41 Network card II

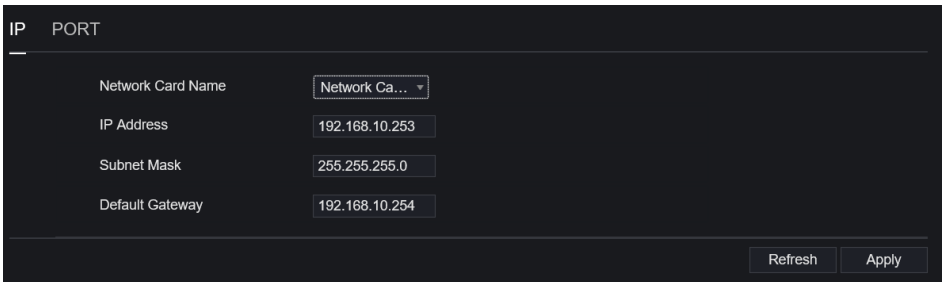

Step 3 Click  next to **IP** to enable or disable the function of automatically getting an IP address. The function is enabled by default.

If the function is disabled, click input boxes next to **IP**, **Subnet mask**, and **Gateway** to set the parameters as required.

Step 4 Click  next to **Obtain DNS Automatically** to enable or disable the function of automatically getting a DNS address. The function is enabled by default.

If the function is disabled, click input boxes next to **DNS1** and **DNS2**, delete original addresses, and enter new addresses.

Step 5 Set **PORT** and **POE** manually, input the information about these.

Figure 9-42 POE

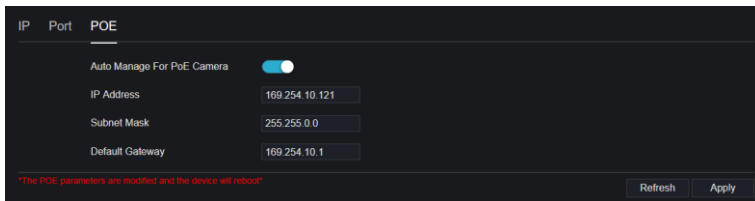

IP	Port	POE
		Auto Manage For PoE Camera <input checked="" type="checkbox"/>
		IP Address 169.254.10.121
		Subnet Mask 255.255.0.0
		Default Gateway 169.254.10.1

The POE parameters are modified and the device will reboot

Refresh Apply

Step 6 Click **Refresh** to restore previous settings. Click **Apply** to save the settings.

----End

9.4.2 DDNS

Procedure

Step 1 Click **DDNS** in the network interface, choose **Network > DDNS** to access the DDNS interface as shown in Figure 9-43.

Figure 9-43 DDNS interface

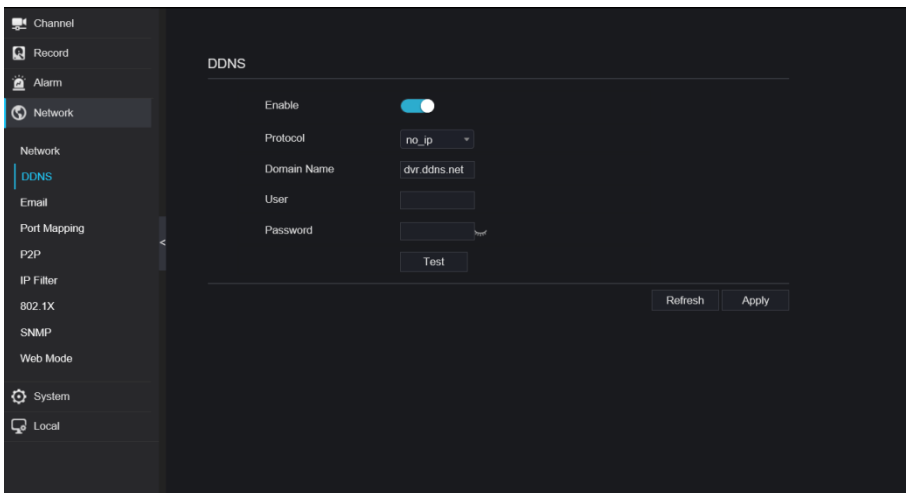

Channel
Record
Alarm
Network
Network
DDNS
Email
Port Mapping
P2P
IP Filter
802.1X
SNMP
Web Mode
System
Local

DDNS

Enable

Protocol no_ip

Domain Name dvr.ddns.net

User

Password

Test

Refresh Apply

Step 2 Click the button to enable the DDNS function. It is disabled by default.

Step 3 Select a required value from the **protocol** drop-down list.

Step 4 Set domain name, user, and password.

Step 5 Click **Refresh** to restore previous settings. Click **Apply** to save the settings.



NOTE

An external network can access an address specified in the DDNS settings to access the NVR.

----End

9.4.3 Email

Procedure

Step 1 Click **Email** in the network interface, choose **Network > Email** to access the E-mail interface, as shown in Figure 9-44

Figure 9-44 Email interface

The screenshot displays the 'Email' configuration page. The left sidebar lists various system settings, with 'Email' highlighted. The main content area includes the following fields and controls:

- SMTP Server: [Text input field]
- SMTP Server Port: 25 [Text input field]
- Username: [Text input field]
- Password: [Text input field]
- Email Sender: [Text input field]
- Email for password reco...: [Text input field]
- Alarm Receiver 1: [Text input field]
- Alarm Receiver 2: [Text input field]
- Alarm Receiver 3: [Text input field]
- SSL Encryption: OFF [Dropdown menu]
- Test: [Button]
- Refresh: [Button]
- Apply: [Button]

Step 2 Set SMTP server and SMTP server port manually.

Step 3 Set sender E-mail, user name and password manually.

Step 4 Set E-mail for receiving the alarm message.

Step 5 Set E-mail for retrieving the password.

Step 6 Click **SSL Encryption** drop-down list to enable safeguard of email.

Step 7 Click **Refresh** to restore previous settings. Click **Apply** to save the settings.

----End

9.4.4 Port Mapping

9.4.4.1 Port Mapping

Procedure

Step 1 Click **Port Mapping** in the network interface, choose **Network > Port Mapping** to access the UPnP interface as shown in Figure 9-45.

Figure 9-45 Port Mapping interface

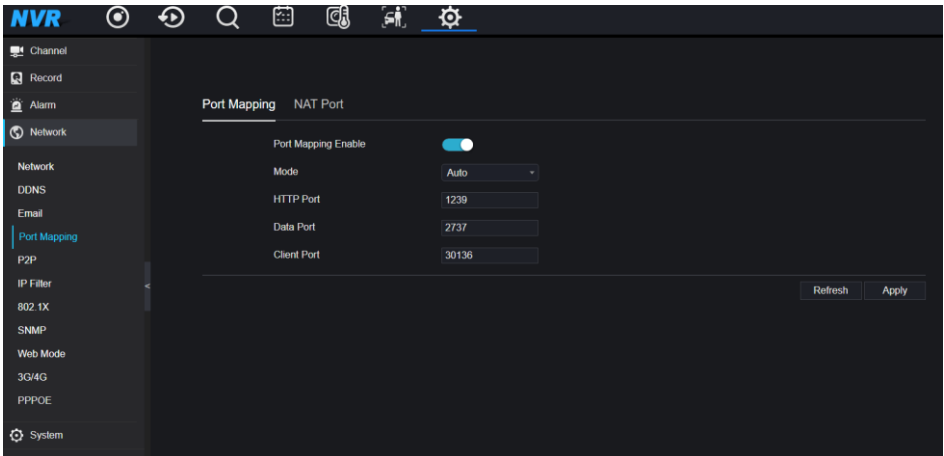

Step 2 Select manner from UPnP enable drop list. The default value is auto.

Step 3 After **UPnP** is manual, set the Web port, data port and client port manually.

Step 4 Click **Refresh** to restore previous settings. Click **Apply** to save the settings.

NOTE

Auto: System perform UPnP automatically.

Manual: The ports are distributed by the router. Input them according to the router.

9.4.4.2 NAT port

NAT (Network Address Translation), users can browse the web of camera by NAT port. There are five ports can be assigned to each camera. Input the start port, the system will compute the end port automatically.

Figure 9-46 NAT port

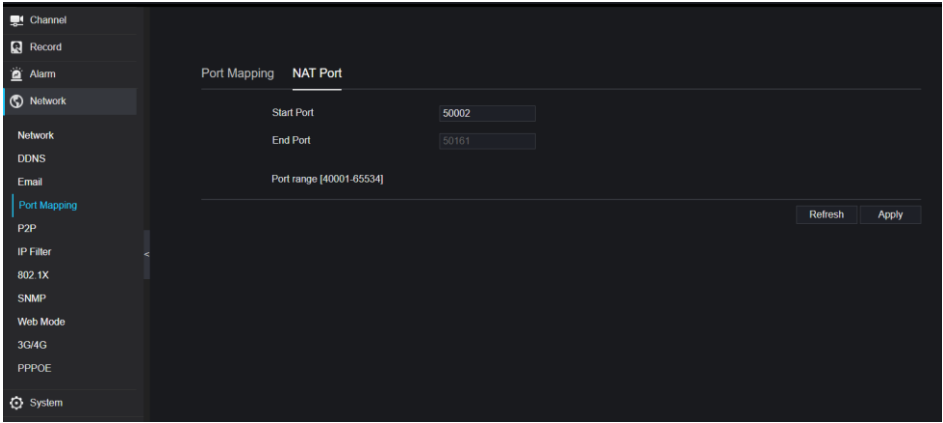

----End

9.4.5 P2P

Procedure

Step 1 Click **P2P** in the network interface, choose **Network > P2P** to access the P2P interface, as shown in Figure 9-47.

Figure 9-47 P2P interface

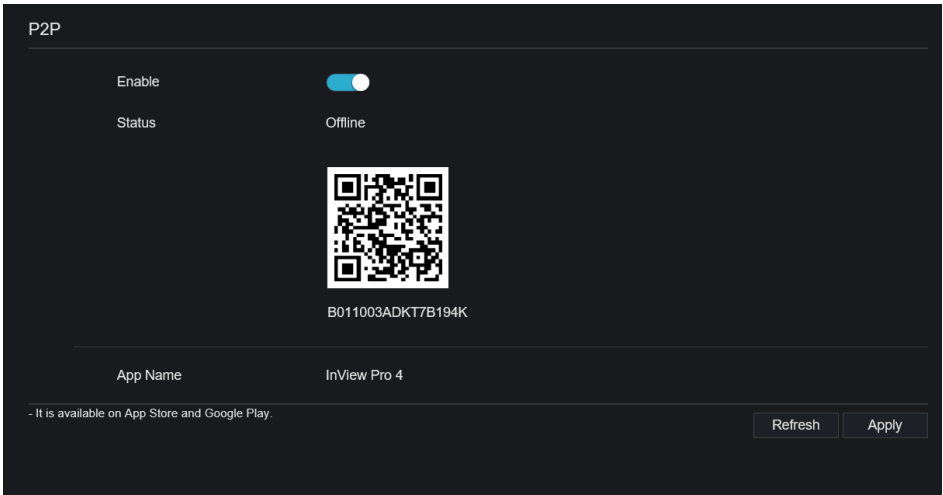

Step 2 Click **Enable** to enable the P2P function.

Step 3 Click **Refresh** to restore previous settings. Click **Apply** to save the settings.

Step 4 After installing Inview Pro 4 in mobile phone, run the app and scan the UUID QR code to add it. And then access the NVR while the device is online.

----End

9.4.6 IP Filter

Procedure

Step 1 Click **IP Filter** in the network interface, choose **Network > IP Filter** to access the IP filter interface, as shown in Figure 9-48.

Figure 9-48 IP filter interface

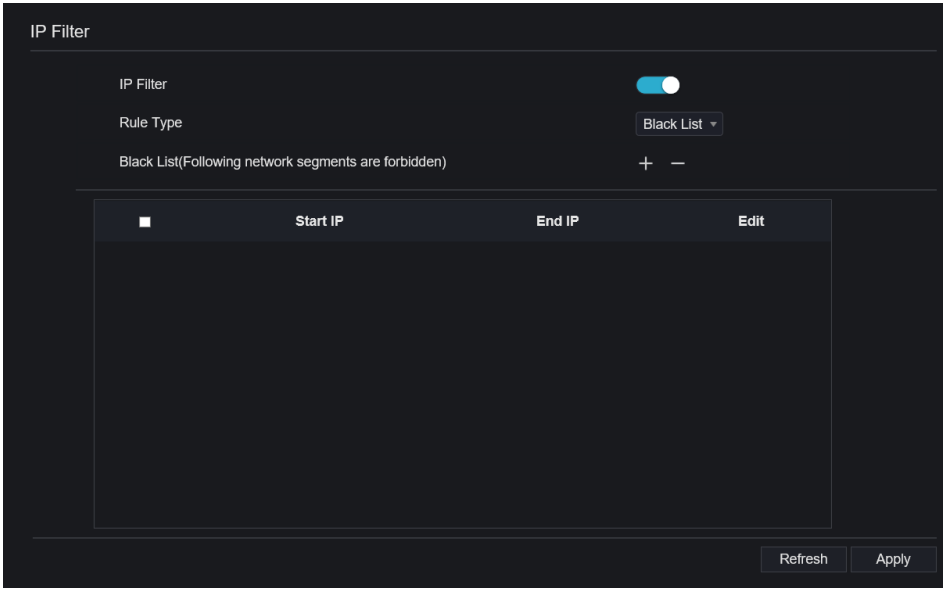

Step 2 Click **Enable** to enable the IP filter function.

Step 3 Click drop-down list of rule type to choose black list or white list.

Step 4 Click , view the pop-up windows to set black list or white list, as shown in 7.5.5.

Click  to delete the list.

Figure 9-49 Black or white list interface

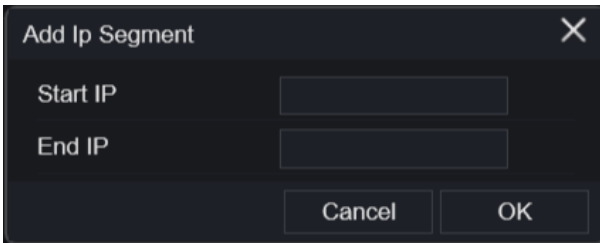

Step 5 Set start IP and end IP.

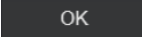
Step 6 Click  to deny settings, click  to save the settings.

Step 7 Click **Refresh** to restore previous settings. Click **Apply** to save the settings.

NOTE

Black list: IP address in specified network segment to prohibit access.
White list: IP address in specified network segment to allow access.
Select a name in the list and click Delete to delete the name from the list.
Select a name in the list and click Edit to edit the name in the list.
Only one rule type is available, and the last rule type set is efficient.

----End

9.4.7 802.1X

Procedure

Step 1 Click **802.1X** in the network interface, 802.1X interface is displayed, enable the button, as shown in Figure 9-50.

Figure 9-50 802.1X interface

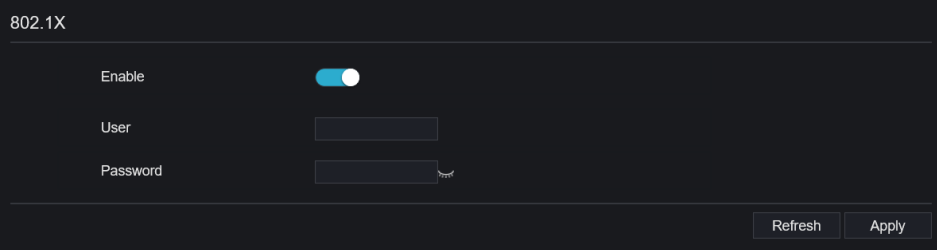

802.1X

Enable

User

Password

Refresh Apply

Step 2 Input the user and password of 802.1X authentication.

Step 3 Click **Refresh** to restore previous settings. Click **Apply** to save the settings.

----End

9.4.8 SNMP

Procedure

Step 1 Click **SNMP** in the network interface, SNMP interface is displayed, enable the button next to SNMPV1, as shown in Figure 9-51.

Figure 9-51 SNMP interface

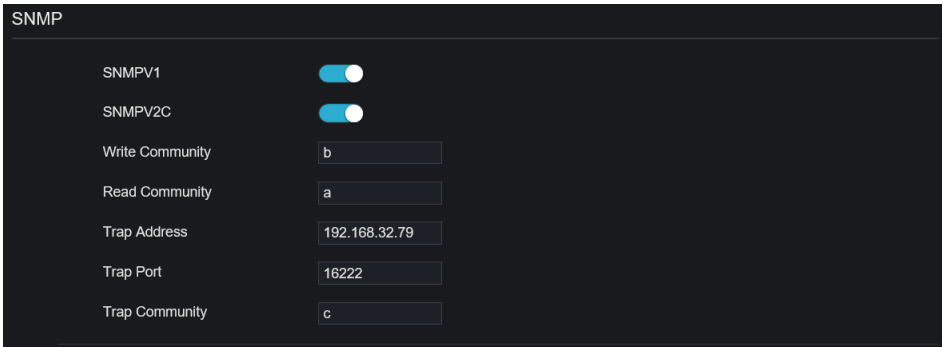

The image shows the SNMP configuration interface. At the top, the title "SNMP" is displayed. Below it, there are two toggle switches: "SNMPV1" and "SNMPV2C", both of which are turned on. Underneath these are several input fields: "Write Community" with the value "b", "Read Community" with the value "a", "Trap Address" with the value "192.168.32.79", "Trap Port" with the value "16222", and "Trap Community" with the value "c".

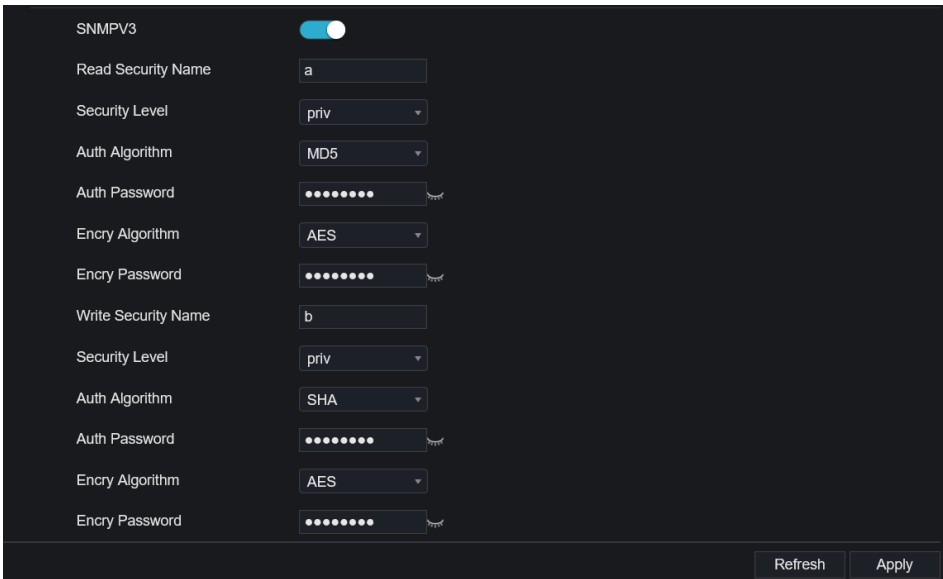

The image shows the SNMPV3 configuration interface. At the top, the title "SNMPV3" is displayed next to a toggle switch that is turned on. Below this, there are two sections of settings. The first section includes: "Read Security Name" (input field with "a"), "Security Level" (dropdown menu with "priv"), "Auth Algorithm" (dropdown menu with "MD5"), "Auth Password" (password field with 10 dots and a visibility icon), "Encry Algorithm" (dropdown menu with "AES"), and "Encry Password" (password field with 10 dots and a visibility icon). The second section includes: "Write Security Name" (input field with "b"), "Security Level" (dropdown menu with "priv"), "Auth Algorithm" (dropdown menu with "SHA"), "Auth Password" (password field with 10 dots and a visibility icon), "Encry Algorithm" (dropdown menu with "AES"), and "Encry Password" (password field with 10 dots and a visibility icon). At the bottom right of the interface, there are two buttons: "Refresh" and "Apply".

Step 2 Input the information of SNMP (simple network management protocol). there are three types of that function. Users can apply that if need.

Table 9-1 SNMP parameters

Parameter	Description	Setting
SMTP Server Address	IP address of the SMTP server.	[Setting method] Enter a value manually.
SMTP Server Port	Port number of the SMTP server.	[Setting method] Enter a value manually. [Default value] 25
User Name	User name of the mailbox for sending emails.	[Setting method] Enter a value manually.
Password	Password of the mailbox for sending emails.	[Setting method] Enter a value manually.
Sender E-mail Address	Mailbox for sending emails.	[Setting method] Enter a value manually.
Recipient_E-mail_Address1	(Mandatory) Email address of recipient 1.	[Setting method] Enter a value manually.
Recipient_E-mail_Address2	(Optional) Email address of recipient 2.	
Recipient_E-mail_Address3	(Optional) Email address of recipient 3.	
Recipient_E-mail_Address4	(Optional) Email address of recipient 4.	
Recipient_E-mail_Address5	(Optional) Email address of recipient 5.	
Attachment Image Quality	A higher-quality image means more storage space. Set this parameter based on the site requirement.	N/A
Transport Mode	Email encryption mode. Set this parameter based on the encryption modes supported by the SMTP server.	[Setting method] Select a value from the drop-down list box. [Default value] No Encrypted

Step 3 Click **Refresh** to restore previous settings. Click **Apply** to save the settings.

----End

9.4.9 Web Mode

Step 1 Click **Web Mode** in the network interface, Web mode interface is displayed, as shown in Figure 5-1.

Figure 9-52 Web mode interface

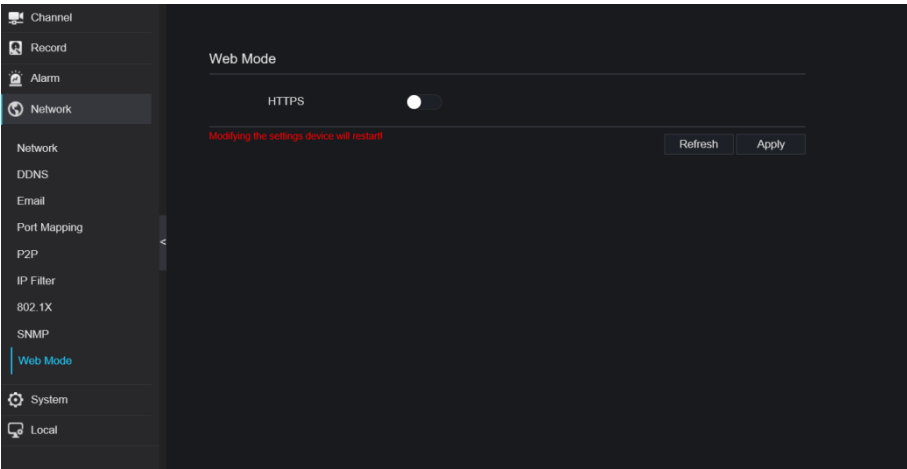

Step 2 Enable the https, the device will restart and start https secure.

Step 3 Click **Refresh** to restore previous settings. Click **Apply** to save the settings.

----End

9.4.10 3G/4G

Figure 9-53 3G/4G

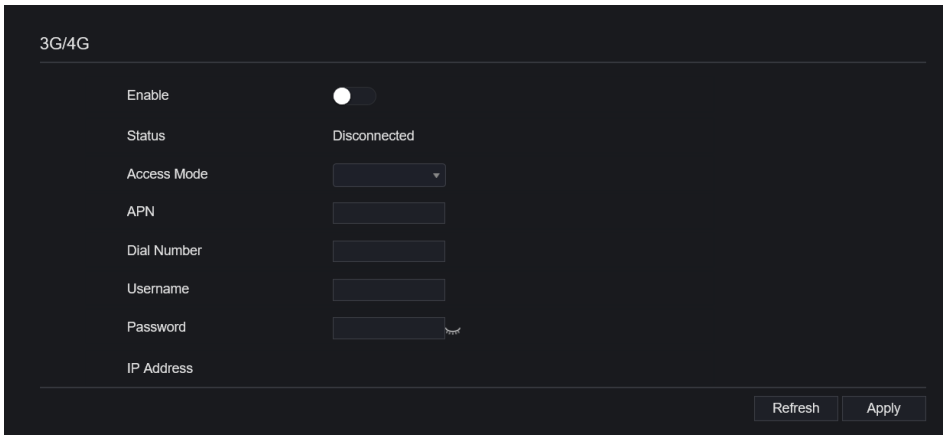

3G/4G

Enable

Status Disconnected

Access Mode

APN

Dial Number

Username

Password

IP Address

Refresh Apply

Step 1 The user plugs the modem to NVR.

Step 2 Enable the 3G/4G.

Step 3 When the status is connected, users can set the access mode, AUTO is recommended.

Step 4 If choose other access mode, users should input the parameter correctly.

Step 5 Click **Refresh** to restore previous settings. Click **Apply** to save the settings.

9.4.11 PPPOE

Users can use PPPOE function to manage the NVR conveniently.

Figure 9-54 PPPOE

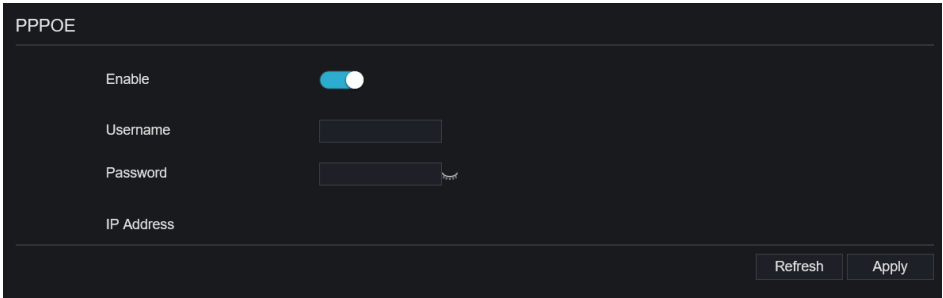

Step 1 Enable the PPPOE.

Step 2 Input the username and password.

Step 3 The IP address is obtained automatically.

Step 4 Click **Refresh** to restore previous settings. Click **Apply** to save the settings.

Step 5 User use the IP address to access NVR immediately.

9.4.12 POE Status (Only for Some Models)

Users can view the POE status at this interface, as shown in Figure 9-55.

Figure 9-55 POE status



9.4.13 Platform Access

For more detail, please refer to UI interface parameter setting [7.4.13 Platform Access](#).

Figure 9-56 Platform access

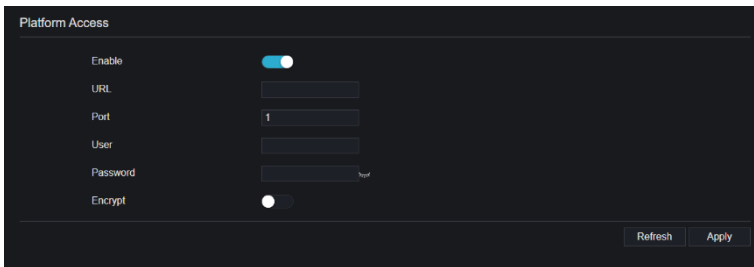

9.5 System

Users can set parameters about information, general, user, password, logs, maintenance and auto restart.

9.5.1 Device Information

Procedure



Step 1 Click  on the navigation bar, the device information interface is displayed, as shown in Figure 9-57.

Figure 9-57 Device information interface

System	Network	Channel	Disk	Alarm
Device ID	B011003AFEK109U62			
Device Name	Device			
Device Type	NVR			
Model	NVR3808E2-PBE-J			
Firmware Version	v4.6.1604.0000.003.0.1.36.0			
U-boot Version	1504010C0F18			
Kernel Version	15060511183A			
HDD Number	2			
Channels Supported	8			
Alarm In	8			
Alarm Out	1			
Audio In	1			
Audio Out	1			

Step 2 Set the device name according to Table 9-2.

Table 9-2 Device parameters

Parameter	Description	Setting
Device ID	Unique device identifier used by the platform to distinguish the devices.	[Setting method] The parameter cannot be modified.
Device Name	Name of the device.	[Setting method] System Setting > General Modify the device name.
Device Type	N/A	[Setting method] These parameters cannot be modified.
Model		
Firmware version		
HDD volume		
Channel support		

Parameter	Description	Setting
Alarm in		
Alarm out		
Audio in		
Audio out		

Figure 9-58 Network

System <u>Network</u> Channel Disk Alarm	
Status	Online
IP Address	192.168.0.51
Subnet Mask	255.255.0.0
Default Gateway	192.168.0.1
MAC Address	00:1E:A4:00:42:85
DHCP	OFF
Preferred DNS Server	192.168.0.1
Alternate DNS Server	8.8.8.8
Total Bandwidth	100.00 Mbps

Figure 9-59 Channel

System Network <u>Channel</u> Disk Alarm					
Channel	Name	Status	Video Format	Resolution	Bitrate(kbps)
CH1	Device	Offline	H265/H265	2560*1440/704*576	4096/1024
CH2	Channel12	Online	H265/H265	1920*1080/704*480	4096/1024
CH3	Channel29	Online	H265/H265	1920*1080/704*576	4096/1024
CH4	Device	Online	H264/H264	1920*1080/704*576	2048/1024

Figure 9-60 Disk

Disk	Capacity	Used	SN	Disk Model	Status
Disk1	2TB	901GB	WD-WXE1A791JKF4	WDC WD21PSRX-89AHTY0	Normal

Figure 9-61 Alarm

Channel	Name	Mode	Enable	Recording Channel
Local<-1	Sensor 1	N/O	On	
Local<-2	Sensor 2	N/O	On	
Local<-3	Sensor 3	N/O	On	
Local<-4	Sensor 4	N/O	On	
Local->1		Close		

----End

9.5.2 General

You can set system, date and time, time zone and DST general interface.

Procedure

Step 1 On the **System Setting** screen, choose **System >General** to access the general interface, as shown in Figure 9-62.

Figure 9-62 Basic setting interface

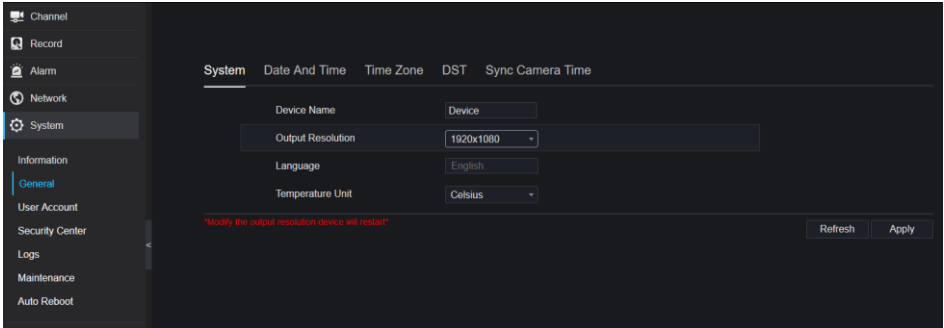

Step 2 Set system.

1. Input the device name.
2. Choose output resolution from drop list.
3. Click **Apply** to save the system setting.

Step 3 Set date and time.

1. Synchronize the time from the NTP server.
2. Click NTP Sync button to enable synchronize time. The default value is enabling.

Figure 9-63 System interface

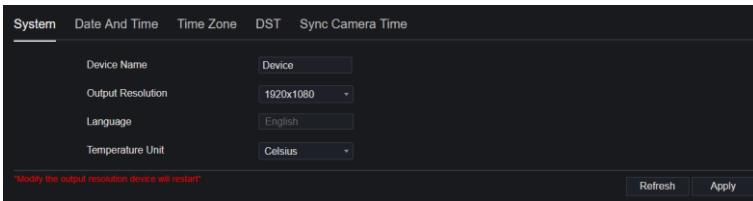

3. Select NTP server, date format and time format from drop list.
4. Click **Apply** to save date and time setting. The device time will synchronize with NTP server time.
5. Set the device time manually, as shown in Figure 9-64.
6. Click NTP Sync button to disable synchronize time.
7. Async date and time interface

Figure 9-64 Date and time

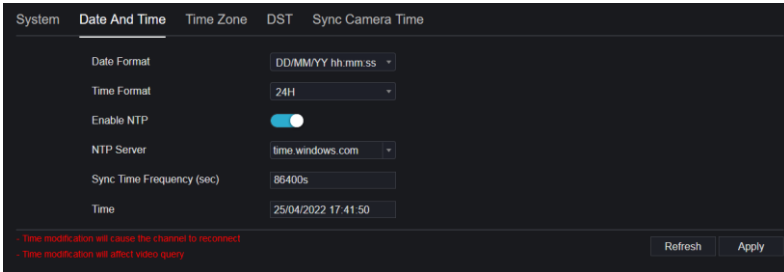

Step 4 Set the time zone.

1. Select date format and time format from the drop-down list.
2. Click **Apply** to save the device time setting. Click **Refresh** to return to previous setting.

Step 5 Set time zone.

Click **Time Zone** to enter the time zone setting interface, as shown in Figure 9-65.

Time zone setting interface

Figure 9-65 Time zone

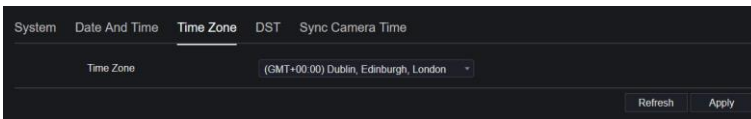

Select a time zone from the drop-down list.

Click **Apply** to save the time zone setting. Click **Refresh** to return to previous setting.

Step 6 Set DST.

1. Click DST to enter the DST setting interface, click DST button to enable, as shown in Figure 9-66. The button is disabled by default.

Figure 9-66 DST setting interface

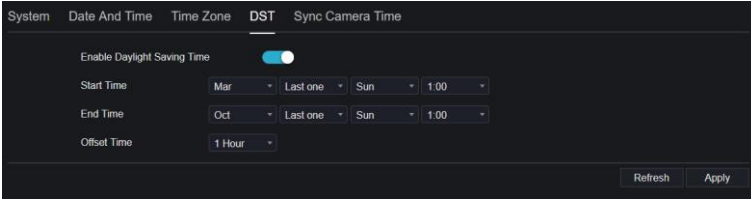

Select a start time from the drop-down list.

Select an end time from the drop-down list.

Select an offset time from the drop-down list.

Figure 9-67 Sync camera time

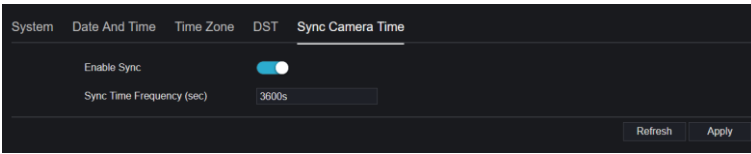

Enable sync camera time, the cameras of NVR management will be showing the same time.
Set the frequency of checks (minimum 10s).

Step 7 Click **Apply** to save the DST setting. Click **Refresh** to return to previous setting.

----End

9.5.3 User Account

You can create new user accounts to manage the device.

9.5.3.1 Add User

Procedure

Step 1 On the **System Setting** screen, choose **System > User** to access the **User** interface, as shown in Figure 9-68.

Figure 9-68 User interface

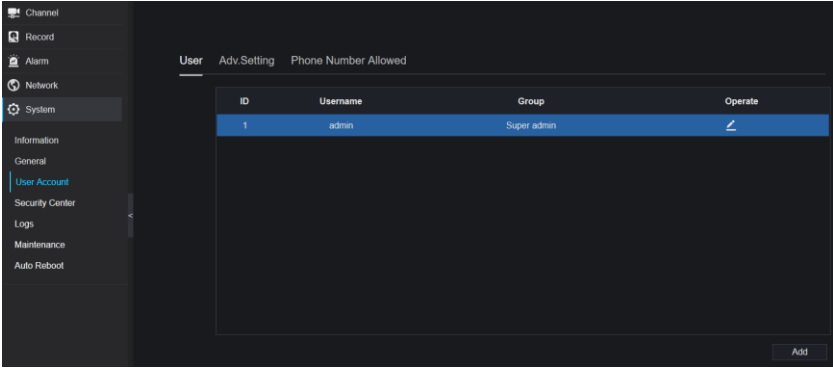

Step 2 Click **Add** to add a new user, as shown in Figure 9-69.

Figure 9-69 Add user

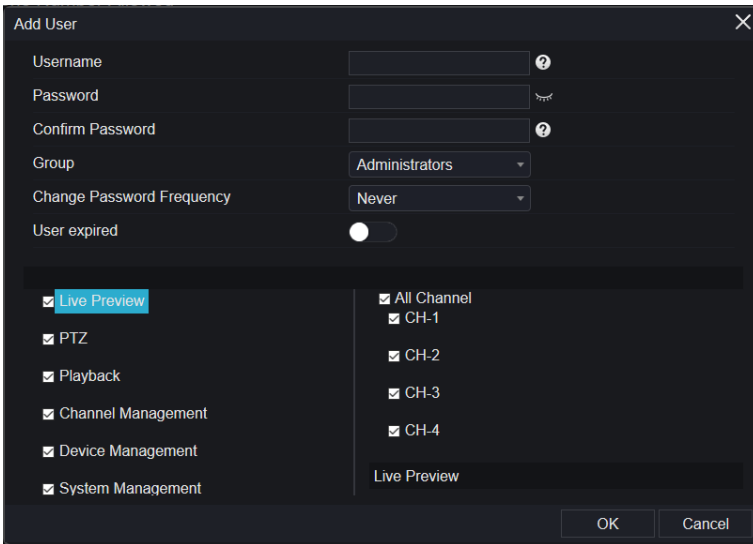

Step 3 Input username, password and confirm password.

Step 4 Select a group and change password reminder from drop-down list.

Step 5 Assign the privilege to the user.

Step 6 Enable the expire date to set the new user's authority time.

Step 7 Select channels to manage.

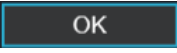
Step 8 Click , the message “**Add success**” is showed. If the password is not

meet the rule, it would show .

Step 9 Click  to edit user’s information.

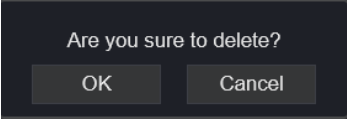
Step 10 Click  to delete the account, it would show .

click  to delete.

----End

9.5.3.2 Adv.Setting

Procedure

Step 1 On the **System Setting** screen, choose **System > User > Adv. Setting** to access interface, as shown in Figure 9-70.

Figure 9-70 Adv. Setting interface

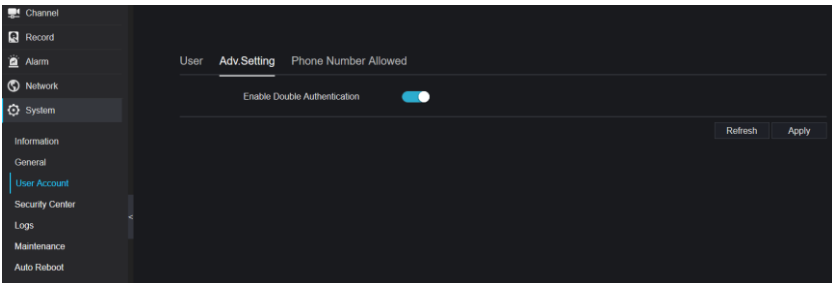

Step 2 Enable the **Password double authentication**. If the user want to playback video, he need input another username and password to authenticate.

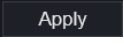
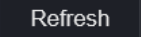
Step 3 Click  to save the device time setting. Click  to return to previous setting.

----End

9.5.3.3 App Verification

Add the digital number to white list, when the user logs in the cellphone App to manage the NVR, A series of numbers must be added in the whitelist for testing and verification to ensure the security.

Figure 9-71 App Verification

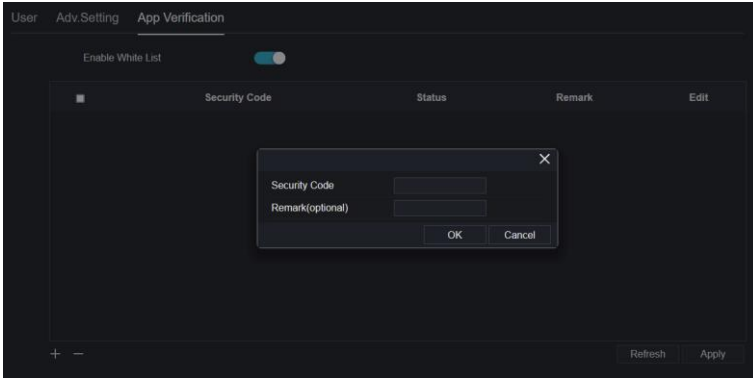

9.5.4 Security Center

9.5.4.1 Password

Procedure

Step 1 On the **System Setting** screen, choose **System > Security Center** to access password interface, as shown in Figure 9-72.

Figure 9-72 Password interface

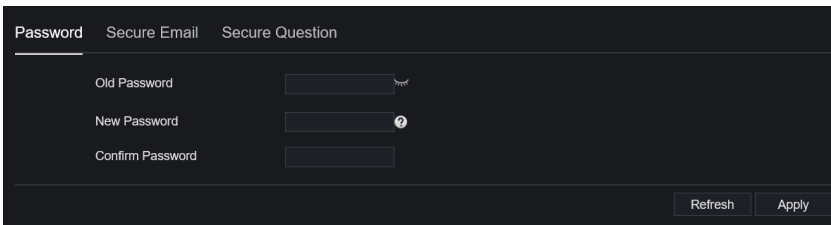

Step 2 Input old password, new password and confirm password.

Step 3 Click **Apply** to save settings. Click **Refresh** to return to previous setting.

NOTE

Valid password range [6-32] characters.

At least 2 kinds of numbers, lowercase, uppercase or special character contained.

Only special characters are support ! @#&*+=-%&''()/./ :;<>?^|~[]{}.

----End

9.5.4.2 Secure Email

The secure email can receive the verification code of NVR, if user forgot the password accidentally.

Figure 9-73 Secure Email

----End

9.5.4.3 Secure Question

If the user forgets the password and answers the security question correctly, the user can change the password to log in to the NVR..

----End

9.5.5 Logs

9.5.5.1 System Logs

Procedure

Step 1 On the **System Setting** screen, choose **System > Logs** to access logs interface, as shown in Figure 9-74.

Figure 9-74 System log interface

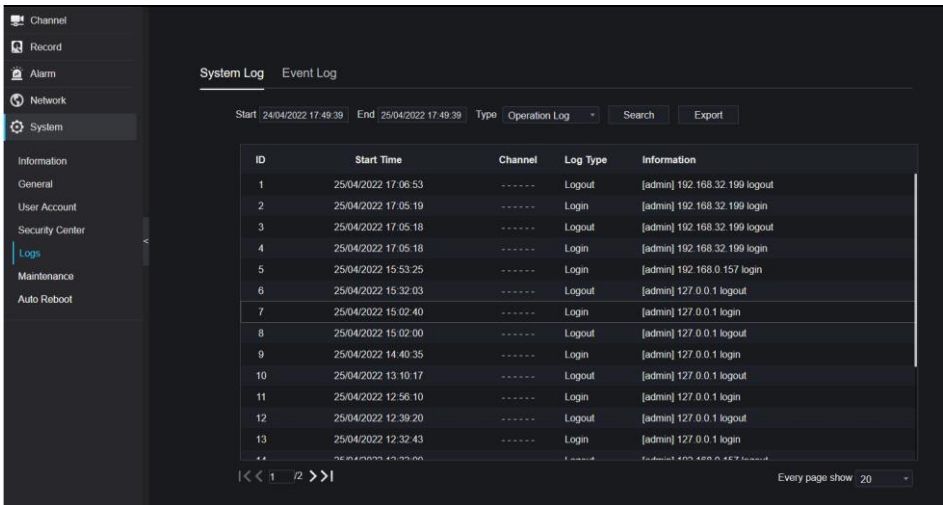

Step 2 Set start and end time from calendar.

Step 3 Select log type from drop-down list.

Step 4 Click **Search** to acquire log information.

Step 5 Click **Export** to export the logs.

----End

9.5.5.2 Event

Procedure

Step 1 On the **System Setting** screen, choose **System > Logs > Event** to access logs interface, as shown in Figure 9-75.

Figure 9-75 Event log interface

ID	Start Time	Channel	Log Type	Information
1	25/04/2022 17:50:23	Channel05	Motion Detection	Channel05
2	25/04/2022 17:49:09	Channel05	Motion Detection	Channel05
3	25/04/2022 17:48:47	Channel05	Motion Detection	Channel05
4	25/04/2022 17:41:03	Channel05	Motion Detection	Channel05
5	25/04/2022 17:37:29	Channel05	Motion Detection	Channel05
6	25/04/2022 17:37:02	Channel05	Motion Detection	Channel05
7	25/04/2022 17:33:55	Channel05	Motion Detection	Channel05
8	25/04/2022 17:32:07	Channel05	Motion Detection	Channel05
9	25/04/2022 17:31:06	Channel05	Motion Detection	Channel05
10	25/04/2022 17:29:06	Channel05	Motion Detection	Channel05
11	25/04/2022 17:28:16	Channel05	Motion Detection	Channel05
12	25/04/2022 17:28:01	Channel05	Motion Detection	Channel05
13	25/04/2022 17:25:15	Channel05	Motion Detection	Channel05

Step 2 Set start and end time from calendar.

Step 3 Select event type from drop-down list.

Step 4 Click **Search** to acquire log information.

Step 5 Click **Export** to export the event logs.

----End

9.5.6 Maintenance

Procedure

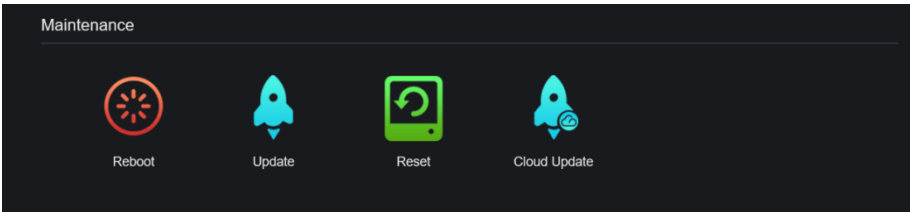

Step 1 On the **System Setting** screen, choose **System > Maintenance** to access maintenance interface, as shown in Figure 9-76.

Figure 9-76 Maintenance interface

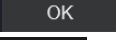

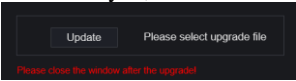
Step 2 Click **Reboot**, the pop-up message will show you, click  to reboot.

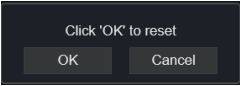
Step 3 Click **Update**, the message shows , choose software from specific location to update.

Step 4 Click **Reset**, the pop-up message  shows to you, click  to reset.

Step 5 If the device is online, and the cloud server has the software, click the **Cloud Update**, it shows 'make sure to update', click **OK** to update.

----End

9.5.7 Auto Reboot

Procedure

Step 1 On the **System Setting** screen, choose **System > Auto Reboot** to access auto restart enable the auto restart, the screen as shown in Figure 9-77.

Figure 9-77 Auto restart

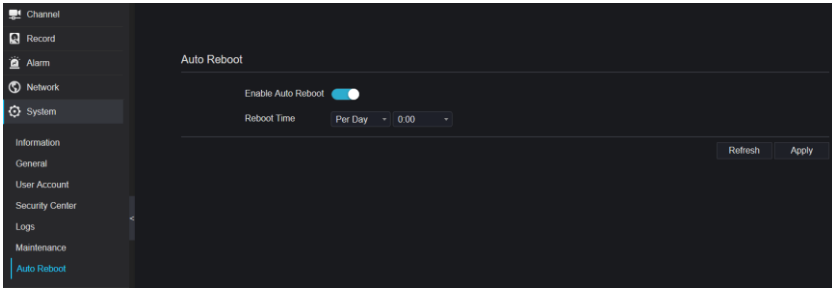

Step 2 Select one type of restart time from drop-down list.

Step 3 Click **Apply** to save settings. Click **Refresh** to return to previous setting.

----End

9.6 Local (Supplied for IE Browser)

Set the image download path for snapshot and the record download path for record files in the download configuration interface.

NOTE

This function is only used for IE browser.

Procedure

Step 1 Click **Local Download Config** in local interface, as shown in Figure 9-78.

Figure 9-78 Local interface

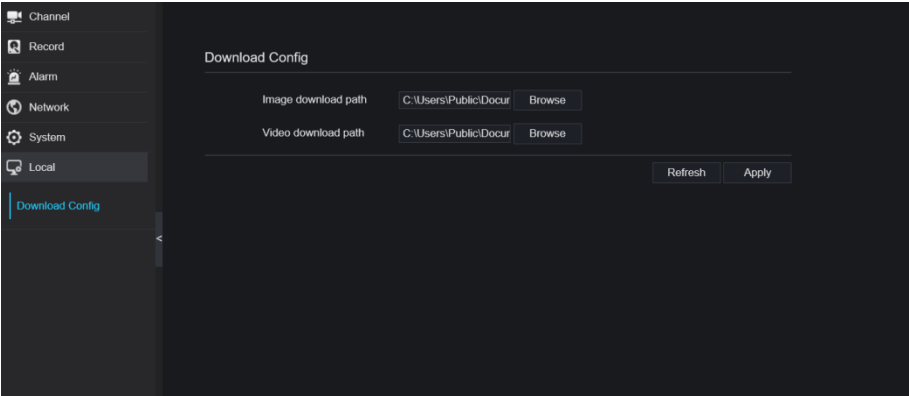

Step 2 Enter the image download path.

Step 3 Enter the record download path.

Step 4 Click **Refresh** to return the previous settings. Click **Apply** to save the settings.

----End

10 Disk Compatibility

The hard disks in the following list are tested and certified by our company, if you want to use other hard disks, please consult to our technical staff.

Table 10-1 Disk specification

Disk Brand	Type	Capacity	Model	Parameter	Verification of Platform
WD (Western Digital)	Monitoring level	3T	WD30EJRX-89G3VY0	3000G/5400RPM/64MB/SATA	NVR25 Series /NVR 26 Series /ADR33 Series /ADR36 Series
		1T	WD10EJRX-89N74Y0	1000G/5400RPM/64MB/SATA	NVR25 Series /NVR 26 Series /ADR33 Series /ADR36 Series
		4T	WD40PURX-64GVNY0	4000G/5400RPM/64MB/SATA	NVR25 Series /NVR 26 Series /ADR33 Series /ADR36 Series
		2T	WD20EURS-63S48Y0		NVR25 Series /NVR 26 Series /ADR33 Series /ADR36 Series
		3T	WD30EURS-63SPKY0		NVR25 Series /NVR 26 Series /ADR33 Series /ADR36 Series
		0.5T	WD5000AAKK-001CA0		NVR25 Series /NVR 26 Series /ADR33 Series /ADR36 Series
		1T	WD10EZE X-00BN5A0	1000G/7200RPM/64MB/SATA	NVR25 Series /NVR 26 Series /ADR33 Series /ADR36 Series
		4T	WD40EJRX-89T1XY0	4000G/5400RPM/64MB/SATA	NVR25 Series /NVR 26 Series /ADR33 Series /ADR36 Series
		3T	WD30PURX-64P6ZY0	3000G/5400RPM/64MB/SATA	NVR25 Series /NVR 26 Series /ADR33 Series /ADR36 Series
		6T	WD60PURX-64WYOY1	6000G/5400RPM/64MB/SATA	NVR25 Series /NVR 26 Series /ADR33 Series /ADR36 Series
	8T	WD82EJRX-89AD9Y0		NVR25 Series /NVR 26 Series /ADR33 Series /ADR36 Series	
	Desktop	12T	WD121EJRX-89S5UY0	7200RPM/256MB/SATA	NVR25 Series /NVR 26 Series /ADR33 Series /ADR36 Series
Seagate	Monitoring level	2T	ST2000VX000	2000G/5900RPM/64MB/SATA	NVR25 Series /NVR 26 Series /ADR33 Series /ADR36 Series
		2T	ST2000VX008	2000G/5900RPM/64MB/SATA	NVR25 Series /NVR 26 Series /ADR33 Series /ADR36 Series
		4T	ST4000VX0	4000G/5900RPM	NVR25 Series /NVR 26

			00	M/ 64MB/SATA	Series /ADR33 Series /ADR36 Series
		3T	ST3000VX000	3000G/5900RP M/64MB/SATA	NVR25 Series /NVR 26 Series /ADR33 Series /ADR36 Series
		4T	ST3000VX010		NVR25 Series /NVR 26 Series /ADR33 Series /ADR36 Series
		1T	ST31000528AS		NVR25 Series /NVR 26 Series /ADR33 Series /ADR36 Series
		6T	ST6000VX0001		NVR25 Series /NVR 26 Series /ADR33 Series /ADR36 Series
		3T	ST3000VX010	3000G/5900RP M/64MB/SATA	NVR25 Series /NVR 26 Series /ADR33 Series /ADR36 Series
		8T	ST8000VX0002		NVR25 Series /NVR 26 Series /ADR33 Series /ADR36 Series
	Enterprise level	6T	ST6000VN0011	6000G/7200RP M/128MB/SATA	NVR25 Series /NVR 26 Series /ADR33 Series /ADR36 Series
Toshiba	Monitoring level	1T	DT01ABA100V	1000G/5400 RPM /32MB/SATA	NVR25 Series /NVR 26 Series /ADR33 Series /ADR36 Series
WD (Western Digital)	Monitoring level	4T/6T/2T/1T	WD41PSRX	4000G/5400RP M/64MB/SATA	NVR25 Series /NVR 26Series /NVR 36Series /ADR33Series /ADR36Series
		2T	WD20EJRX-89AKWYO	2000G/5400RP M/64MB/SATA	NVR25 Series /NVR 26Series /NVR 36Series /ADR33Series /ADR36Series
		10T			NVR25 Series /NVR 26Series /NVR 36Series /ADR33Series /ADR36Series
		6T	WD62EJRX-89B2VY0		NVR 36Series
		10T	WD102EJRX-89YN0Y0		NVR 38 Series /NVR 36Series /ADR33Series
		18T	WD180EJRX-89AFLY0		NVR 38 Series /NVR 36Series
		8T	WD84EJRX-89B2TY0		NVR 38 Series /NVR 36Series

Video recording size per channel per hour =bitrate (kbps)*3600/1200/8 (M)

Recording duration =Total hard disk capacity (M) / Video recording size per channel per hour / number channels (H)